

# Electrification & renewables to displace fossil fuel process heating

Research theme B3



---

## Final Report

### RACE for Business Program

### Research Theme B3: Decarbonising industrial process heating

Project Code: 20.B3.A.0121

ISBN: 978-1-922746-02-3

October 2021

## Project team

### University of South Australia

Michael Evans  
Martin Belusko  
Ming Liu  
Patrick F. Keane  
Ke Xing  
Tim Lau  
Frank Bruno

### Queensland University of Technology

Alireza Taghipour  
Thomas Rainey  
Aaron Liu  
Wendy Miller

### Australian Alliance for Energy Productivity

Jarrod Leak

### Royal Melbourne Institute of Technology

Jack Nihill  
Cameron Stanley  
Gary Rosengarten  
Abhijit Date  
Ruhul Amin  
Bruce Bonney

### University of Technology Sydney

Jihane Assaf  
Jahangir Hossain

The Reliable Affordable Clean Energy for 2030 Cooperative Research Centre (RACE for 2030 CRC) is a 10-year, \$350 million Australian research collaboration involving industry, research, government and other stakeholders. Its mission is to drive innovation for a secure, affordable, clean energy future.

<https://www.racefor2030.com.au>

## Project partners



## Authors

Michael Evans, Martin Belusko, Alireza Taghipour, Ming Liu, Patrick F. Keane, Jack Nihill, Ruhul Amin, Aaron Liu, Jihane Assaf, Tim Lau, Ke Xing, Thomas Rainey, Cameron Stanley, Abhijit Date, Bruce Bonney, Jarrod Leak, Jahangir Hossain, Wendy Miller, Gary Rosengarten, Frank Bruno

## Disclaimers

This report has been prepared by the authors at the request of the Reliable Affordable Clean Energy for 2030 Cooperative Research Centre (RACE for 2030 CRC). It is intended solely to provide information on renewable energy options for low temperature industrial process heat. The information contained in this report, including any diagrams, specifications, calculations, and other data, remains the property of the RACE for 2030 CRC or its original owner as referenced in this report.

This report may not be copied, reproduced, or distributed for commercial purposes, or adapted or modified in any way or for any purpose, without the prior written consent of the RACE for 2030 CRC. Any use of this report must be attributed to the RACE for 2030 CRC.

The analysis and content of this report was completed in June 2021.

The report is provided as is, without any guarantee, representation, condition or warranty of any kind, either express, implied or statutory. The RACE for 2030 CRC and the authors do not assume any liability with respect to any reliance placed on this report by third parties. If a third party relies on the report in any way, that party assumes the entire risk as to the accuracy, currency or completeness of the information contained in the report.

### Executive Summary

In Australia, industry consumes nearly half of the total end use energy, out of which, 37% is used in process heat, representing approximately 750 PJ/yr. The primary source of heat production is fossil fuels, accounting for 90% of all process heat energy consumption. Of all fossil fuels, natural gas is the most commonly used fuel, accounting for approximately 57% of all process heat requirements. The decarbonisation of these heat processes represents a significant challenge for Australian industry. This opportunity assessment reviews the current market status and technology options, identifies the market potential and relevant barriers, and provides a pathway to overcome this challenge. Ultimately, this study informs the future direction for research activities to support industry to achieve decarbonisation reliably and affordably. This assessment for the Reliable Affordable Clean Energy for 2030 Cooperative Research Centre (RACE for 2030 CRC) is focused on processes which require process temperatures of up to 150 °C. This is irrespective of the current temperature of process heat which is initially generated in boilers or steam generators to drive the process.

Major sectors that require process heat in this temperature range include alumina, wood and paper in the manufacturing sector; meat, dairy and beverage from the food processing sector; and hospitality, aged care and hospitals, representing the buildings sector. Collectively these sectors, use 180 PJ/annum, 24% of all industry heating requirements in Australia. In each industry, process heat is delivered at different rates and temperatures but generally continuously and via steam. This includes processes such as digestion, evaporation, air drying, pasteurisation, sterilisation, spray drying, fat and blood processing, washing, hot water, heating and laundry cleaning. Overall, the state of the market highlights that a complex range of interconnected technology solutions will be required to achieve decarbonisation.

A technology review was conducted of various options identified by the technology readiness level metric. Technologies were also categorised by a hierarchy of renewable energy which when combined into a hybrid energy system can deliver 100% decarbonisation at lowest cost. This hierarchy identified that the lowest cost delivery of heat is directly from renewable energy and energy efficiency, followed by thermal energy storage with the remainder delivered through green fuels, representing the highest cost solution. It was identified that best practice energy efficiency deserves immediate attention which can provide instant benefits but also reduce the investment needed for technology solutions. Renewable energy solutions include solar PV with heat pump/MVR or electric boilers, solar thermal, biogas/biomass burning, together with thermal storage. Biogas upgrading to biomethane, green diesel and hydrogen are green fuel options, which combined with other technology solutions can deliver 100% decarbonised solutions at economically competitive levels. These technologies are continuously being advanced together with novel technologies such as electromagnetic-assisted heating solutions which can potentially dramatically reduce process heating needs.

An analysis of the potential of the highlighted technology solutions to displace fossil fuel was conducted for the manufacturing, food processing and buildings sectors. The analysis provides a qualitative and quantitative overview of the options and potential scale of reduction of carbon emissions within these sectors. System solutions were identified which could practically deliver a decarbonised solution. A techno-economic assessment of these options was conducted identifying qualitatively the pathway for decarbonisation. This process informed the technology uptake analysis based on a simplified logistic uptake model.

The uptake modelling was conducted under two scenarios, namely a business-as-usual (BaU) scenario, and an accelerated scenario. Under both scenarios, growth (both negative and positive) was considered based on historical data where available. In the BaU scenario, decarbonisation rates varied

## Electrification & Renewables to Displace Fossil Fuel Process Heating

across sectors, however, were generally less than 30%. An accelerated scenario to achieve 50% reduction was modelled identifying necessary technology take-up rates. Overall, these rates were deemed reasonable suggesting that a 50% reduction in greenhouse gas emissions across the sectors by 2035 could be achieved.

Significant potential reductions of both fuel costs and CO<sub>2</sub> emissions by 2035, compared to a 2019 baseline are identified through the uptake modelling. These data are shown by sector both side-by-side in bar charts and stacked as a function of time in the figures below, highlighting contributions of each sector. Although it is apparent that alumina refining is a significant contributor to the accelerated savings, it – like most sectors – will suffer from substantial increases in costs and produce more emissions under the BaU scenario. These discrepancies are particularly dire for low temperature heat usage in commercial buildings. Without substantial uptake of renewable heat production technologies, many of the sectors identified in this report will continue to produce increasing CO<sub>2</sub> emissions with additional the burden of higher financial costs.

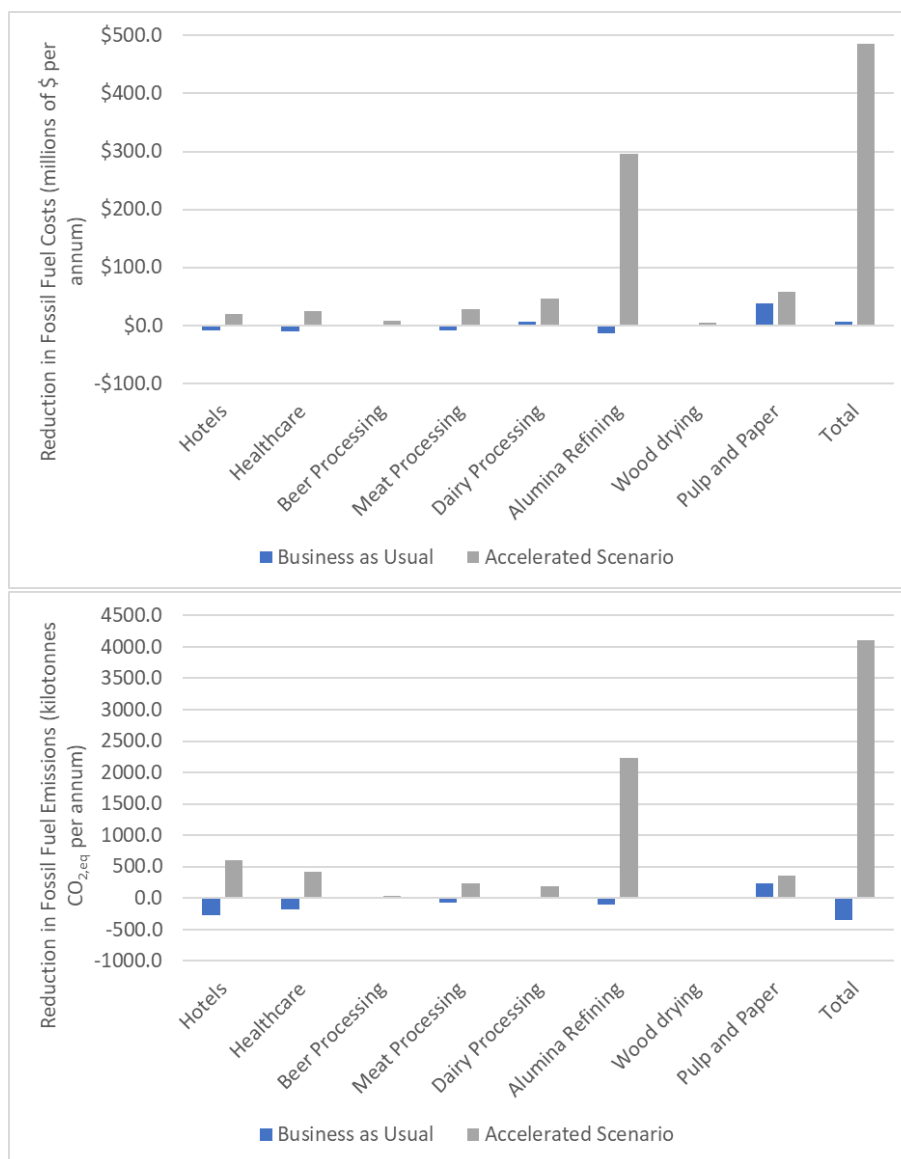

## Electrification & Renewables to Displace Fossil Fuel Process Heating

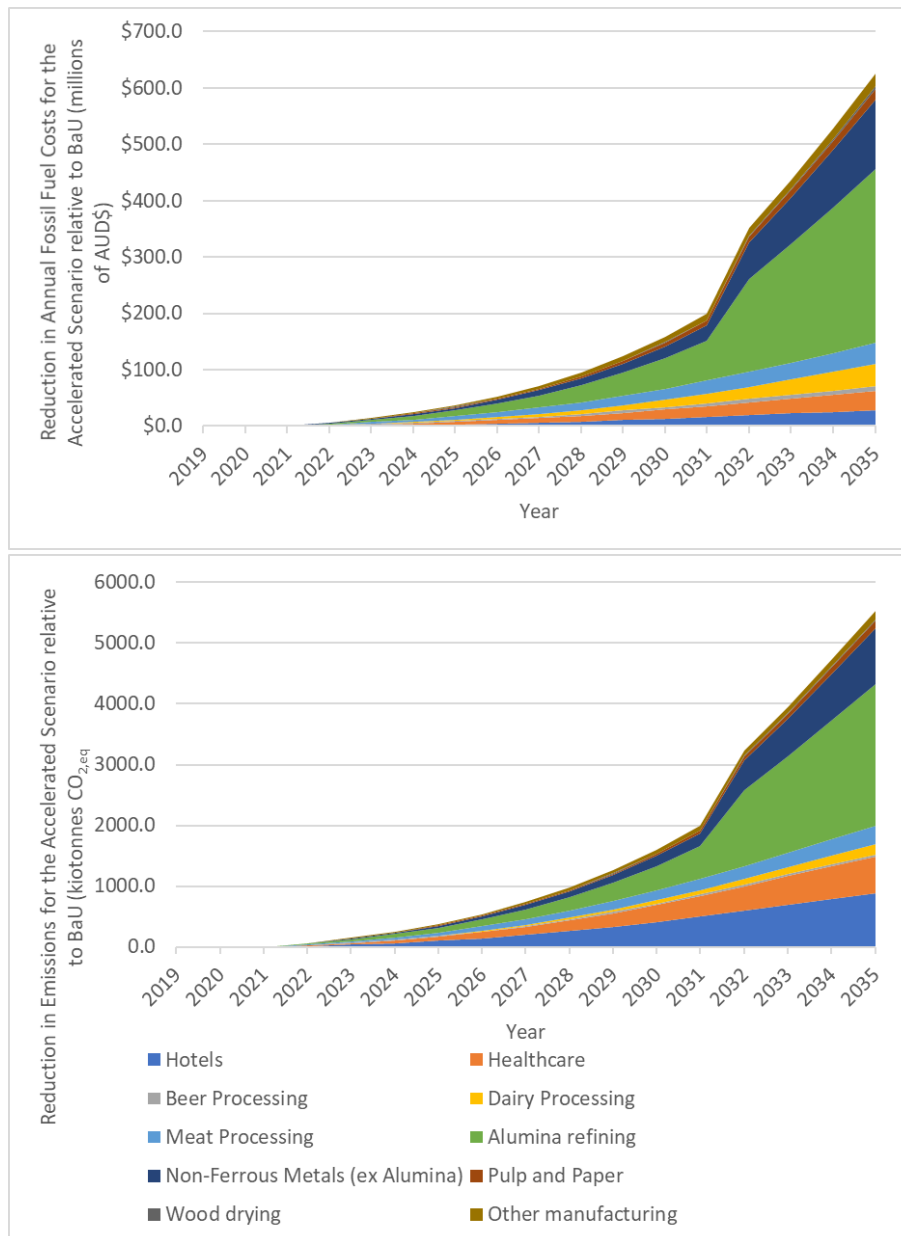

The barriers to achieving the potential of the accelerated modelling scenario are substantial and have been investigated and categorised as technical, non-technical, and regulatory and commercial. Technology integration issues and impacts on the grid, together with a lack of insufficient data of heating processes have been identified as technical barriers. Non-technical barriers include a lack of knowledge, skills, tools, training as well as cultural factors. There exists a lack of regulations, and a lack of understanding of how existing regulations will affect technology implementation. Finally, the costs and commercial constraints represent a major barrier. Each of the barrier groups are analysed followed by relevant recommendations and suggestions that can aid industry sectors to reduce or overcome these barriers or which form the basis of future research questions for the theme.

From this study recommended research activities are provided to overcome these barriers and deliver a clear pathway to impact. Proposed activities include system modelling to identify value propositions, technology demonstrations to de-risk solutions, awareness and engagement activities to provide confidence building measures, and investigation of policy instruments to enable accelerated technology uptake. These activities aim to deliver reduced energy costs of up to 600 million AUD per annum, 50% reduction in greenhouse gas emissions by 2035 and improve energy reliability to industry.

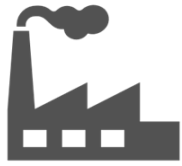

**Manufacturing and processing**

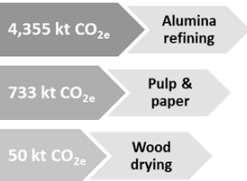

**Agriculture food and beverage**

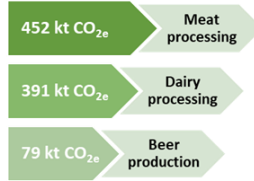

**Commercial and services**

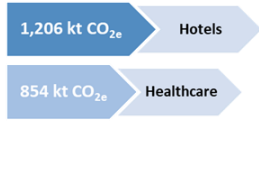

## Major consumers of process heat below 150°C for 2020.

The combined emissions from process heat below 150°C for these eight industries is 9.8 Mt CO<sub>2,eq</sub> which accounts for approximately 52% of total industrial emissions from process heat in this temperature range.

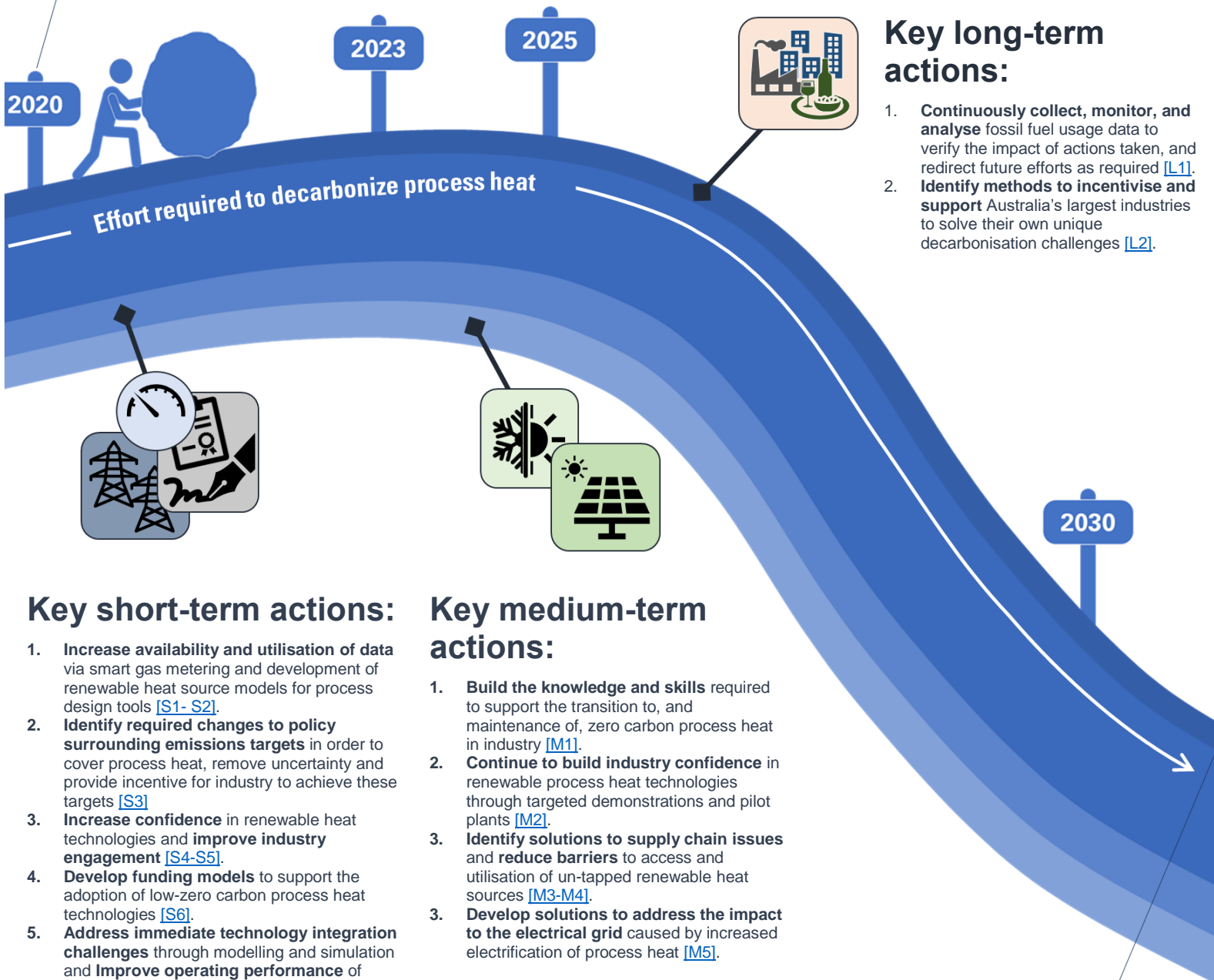

## Key long-term actions:

1. **Continuously collect, monitor, and analyse** fossil fuel usage data to verify the impact of actions taken, and redirect future efforts as required [\[L1\]](#).
2. **Identify methods to incentivise and support** Australia's largest industries to solve their own unique decarbonisation challenges [\[L2\]](#).

## Key short-term actions:

1. **Increase availability and utilisation of data** via smart gas metering and development of renewable heat source models for process design tools [\[S1-S2\]](#).
2. **Identify required changes to policy surrounding emissions targets** in order to cover process heat, remove uncertainty and provide incentive for industry to achieve these targets [\[S3\]](#).
3. **Increase confidence** in renewable heat technologies and **improve industry engagement** [\[S4-S5\]](#).
4. **Develop funding models** to support the adoption of low-zero carbon process heat technologies [\[S6\]](#).
5. **Address immediate technology integration challenges** through modelling and simulation and **improve operating performance** of technologies that are on the brink of being able to meet the demands of industry [\[S7-S8\]](#).

## Key medium-term actions:

1. **Build the knowledge and skills** required to support the transition to, and maintenance of, zero carbon process heat in industry [\[M1\]](#).
2. **Continue to build industry confidence** in renewable process heat technologies through targeted demonstrations and pilot plants [\[M2\]](#).
3. **Identify solutions to supply chain issues and reduce barriers** to access and utilisation of un-tapped renewable heat sources [\[M3-M4\]](#).
3. **Develop solutions to address the impact to the electrical grid** caused by increased electrification of process heat [\[M5\]](#).

Targeting **50% reduction in emissions** from process heat below 150°C **by 2035**

# Industrial Process Heat Decarbonisation: Research Roadmap

## Barriers – Type and colour code

Technology
Economic
Impact on the electricity grid
Regulations and standards
Knowledge, skills, training, and culture
Data availability and utilisation

Short-, medium- and long-term research opportunities (designated as S, M and L respectively) that will contribute to reaching a 50% reduction in CO<sub>2,eq</sub> emissions from industrial process heat below 150 °C by 2035. Research opportunities are grouped based on their required year of completion listed in order of chronological dependence where applicable. The start date required to meet these milestones will depend on the relative scale (budget, work hours needed etc.) of each opportunity. Projects that will need to be initiated before 2023 have been identified. Priority has been given to medium-to-high TRL projects where applicable. Taking these actions, especially those listed in the short and medium term, will build momentum, leading industry onto the path towards complete decarbonisation of process heat.

Index	Barrier	Research opportunity	Research questions	Start before 2023
S1	Availability of detailed fossil fuel usage data	Potential for a combination of smart gas metering and targeted process heat energy flow analysis to provide more granular data on industry fossil fuel use for process heating and to make potential energy savings visible to end users.	<ol style="list-style-type: none"> <li>How can smart gas meters be rolled out more extensively?</li> <li>What are the specific areas of inefficiency in Australian industrial process heat?</li> </ol>	✓
S2	Lack of renewable process heat technologies included in process simulation tools	Providing process modelling tools for accurate design and assessment of methods for economically reducing fossil fuel consumption in process heating.	<ol style="list-style-type: none"> <li>What is the best approach for modelling and simulating the various industries for both energy efficiency improvement and renewable application analysis (e.g., commercial software, existing open-source software or develop new software)?</li> <li>Are new algorithms for renewable technologies better developed as plug-ins to existing software or integrated into existing software?                             <ol style="list-style-type: none"> <li>What new/revised component-level (e.g., heat exchangers, heat pumps, thermal energy storage) information/models are required to enable accurate and reliable system-wide models?</li> </ol> </li> <li>What data is required for model validation, and how do we obtain this information?</li> </ol>	✓
S3	Policy uncertainty	Effect of clear and consistent policy regarding emissions targets on the adoption of decarbonising technologies.	<ol style="list-style-type: none"> <li>How can state and federal policy around emissions reduction targets be improved to remove uncertainty in the future economics associated with CO<sub>2,eq</sub> emissions, including those associated with process heat, as well as clarifying the obligations of business in meeting those targets?</li> </ol>	✓
S4	Lack of confidence in renewable process heat technologies	Overcoming past negative experiences with, or misconceptions about different renewable process heat technologies	<ol style="list-style-type: none"> <li>How can the negative impact of prior failed renewable process heat programs be addressed/overcome? (e.g., heat pumps for process heat in the Victorian dairy industry)</li> <li>How can misconceptions regarding the potential performance of renewable process heat supply technologies be addressed?</li> <li>What guidelines and/or standards are needed for selection and implementation of these technologies?</li> </ol>	✓
S5a	Low appetite for risk and lack of industry engagement	Quantifying the impact of investment in process heat decarbonisation for different industry sectors.	<ol style="list-style-type: none"> <li>What is the relative cost of decarbonising process heat for each industry?                             <ol style="list-style-type: none"> <li>How can available funds be most effectively distributed for the greatest impact?</li> </ol> </li> <li>Which industries will benefit the most from a staged approach (i.e., energy efficiency first, followed by technological changes), and which industries would benefit from immediate adoption of new technologies?</li> </ol>	✓
S5b	Low appetite for risk and lack of industry engagement	Potential measures that can drive effective and tangible decarbonisation within Australian Industry by increasing industry engagement	<ol style="list-style-type: none"> <li>How do you get industry to participate/invest?</li> <li>How do we encourage a decarbonisation 'ecosystem'?</li> <li>What mechanism/s can act as a 'stick'? i.e., how can a cost be attached to doing nothing?</li> <li>What can act as a carrot? e.g., clean energy rebates, local government capex avoidance, third party thermal energy purchasing contracts etc.</li> <li>How can learnings from other successful programs be leveraged?                             <ol style="list-style-type: none"> <li>Could a rating scheme similar to NABERS be employed for process heat?</li> </ol> </li> <li>How can tangential environmental targets be leveraged to encourage adoption of renewable heat sources? e.g., refrigerant phase out targets</li> </ol>	✓
S5c	Low appetite for risk and lack of industry engagement	Development of a database of desktop case studies (e.g., drawing on output of master's research programs) applicable to different technologies.	<ol style="list-style-type: none"> <li>How can the benefits of different renewable process heat technologies with respect to specific sites and specific process be communicated to the people making investment decisions in those industries?</li> </ol>	✓
S5d	Low appetite for risk and lack of industry engagement	Improving understanding around the additional commercial and environmental benefits of renewable heat technologies.	<ol style="list-style-type: none"> <li>What are the secondary (non-energy) benefits associated with decarbonising process heating (e.g., improved process monitoring, productivity, data capture and analysis, maintenance scheduling etc.)</li> </ol>	✓
S6	Access to capital	Innovative funding models to support low-zero carbon process heat retrofitting	<ol style="list-style-type: none"> <li>Are there any low-risk innovative options to fund projects?</li> </ol>	✓
S7	Technology integration	Detailed modelling and analysis of the different renewable process heat technologies identified in this opportunity assessment applied to the respective industrial processes.	<ol style="list-style-type: none"> <li>Based on the detailed modelling, what are the best renewable options to integrate into these industries?</li> </ol>	✓
S8	Technology integration	Addressing the limitations for high/mid TRL heat pump and mechanical vapour recompression technologies	<ol style="list-style-type: none"> <li>What are the factors limiting the availability and integration of commercial high temperature heat pumps for 150 °C applications?</li> <li>How can new-generation heat transfer fluids, e.g., supercritical CO<sub>2</sub>, aid integration in industrial process heat recovery applications?</li> <li>What factors ultimately restrict contaminated water vapour being used with mechanical vapour recompression technologies and how can these be overcome to facilitate the use of "dirty" water sources?</li> </ol>	✓

Short-term actions: Complete by 2023



	Index	Barrier	Research opportunity	Research questions	Start before 2023
Medium-term actions: Complete by 2025	M1	Availability of required expertise within the broader workforce	Capacity for skills and knowledge sharing/symbiosis between industries to support the transition to zero carbon process heat, including the promotion of an integrative design approach.	<ol style="list-style-type: none"> <li>1. What existing industries have the skills/expertise required to support different renewable process heat technologies? E.g., refrigeration industry and heat pumps.</li> <li>2. How can the required expertise be developed in those industries that will become end users of these technologies? E.g., new undergraduate courses and post grad short courses focusing on integrative design.</li> </ol>	
	M2	Lack of confidence in renewable process heat technologies	Targeted pilot demonstrations, building on the work in this opportunity assessment and subsequent in-depth modelling and analysis, to kickstart market adoption of renewable process heat technologies.	<ol style="list-style-type: none"> <li>1. Which additional industries not covered by this opportunity assessment will benefit most from targeted demonstrations?</li> <li>2. How can demonstrations be designed and/or results communicated to benefit additional industries outside those specifically targeted?</li> </ol>	✓
	M3	Availability of resources	Development of local supply chains for renewable process heat technologies e.g., industrial high temperature heat pumps	<ol style="list-style-type: none"> <li>1. How can early adopters of decarbonising technologies be supported until supply chains are established?</li> <li>2. How will the bespoke nature of renewable process heat solutions effect development of part and equipment supply chains and how can this be overcome?</li> <li>3. How can supply chains/support from tangential industries (e.g., refrigeration) be leveraged?</li> </ol>	
	M4	Availability of resources	Development of technologies to exploit waste streams from different industries for the generation of renewable fuel. e.g., production of biogas from anaerobic wastewater treatment in the Australian paper industry	<ol style="list-style-type: none"> <li>1. What is the feasibility of using out-gassing products (e.g., syngas) for direct combustion?</li> <li>2. Would this require new burners/boilers or can existing plant be used?</li> <li>3. How does this compare to natural gas combustion?</li> <li>4. How does this compare to reformed methane?</li> </ol>	✓
	M5	Impact on the electricity grid	Demand response mechanisms and industry-based energy storage as a means of addressing issues associated with widespread electrification of industrial process heat	<ol style="list-style-type: none"> <li>1. How can the adoption of renewable process heat technologies provide opportunities for demand side energy storage or demand response mechanisms to aid in mitigating the potential negative effects of widespread electrification of process heat?</li> </ol>	
	M6	Technology integration	Accelerating low TRL process heat technologies and breakthrough opportunities in existing technologies	<ol style="list-style-type: none"> <li>1. Are low TRL technologies scalable, and if so, are they affordable and reliable?</li> <li>2. Is it feasible to use material composites as an electromagnetic target for rapid indirect heating/drying?</li> <li>3. How can current inefficiencies and fouling problems in common technologies be significantly improved in combination with the latest understandings in fluid dynamics and thermofluidic engineering?</li> </ol>	

Long-term actions: Complete by 2030	L1	Availability of detailed fossil fuel usage data	Continuous monitoring of fossil fuel usage data and project performance	<ol style="list-style-type: none"> <li>1. How do the projections in the market potential paper compare to emissions calculated from actual detailed fuel use data?</li> <li>2. What is the impact of actions to date on fossil fuel consumption in key industries? [Annual or Biennial review] <ol style="list-style-type: none"> <li>i. How is fossil fuel use tracking against required levels to reach the decarbonisation targets?</li> </ol> </li> <li>3. Are there additional actions/opportunities indicated by the collected data?</li> </ol>	✓
	L2	Cost of development	Funding structures/mechanisms to support industry lead development of decarbonising technology for Australia's largest consumers of process heat.	<ol style="list-style-type: none"> <li>1. What funding mechanisms could be adopted in order to allow the expertise within Australia's largest consumers of industrial process heat to be effectively utilised in tackling the specific issues associated with decarbonising those same industries? <ol style="list-style-type: none"> <li>i. Could renewable energy certificates for process heat decarbonisation be effective?</li> </ol> </li> </ol>	✓

## Contents

Executive Summary.....	iii
Industrial Process Heat Decarbonisation: Research Roadmap.....	vii
Contents.....	ix
List of Figures.....	xii
List of Tables.....	xvii
<b>1 Introduction.....</b>	<b>1</b>
1.1 Report Structure.....	1
<b>2 Market Status.....</b>	<b>3</b>
2.1 Introduction.....	3
2.2 Market Status Methodology.....	3
2.2.1 Process selection.....	3
2.2.2 Process review.....	6
2.3 Market Status Review.....	8
2.3.1 Alumina and non-ferrous metals.....	8
2.3.2 Wood and wood processing.....	11
2.3.3 Pulp and paper industry.....	14
2.3.4 Food product processing and beverage sector.....	18
2.3.5 Heating in hospitals.....	25
2.3.6 Heating in residential aged care facilities.....	28
2.3.7 Heating in hotels.....	30
2.4 Australian and Global Leaders: Best Practices.....	32
2.4.1 Australian Case Studies.....	32
2.4.2 International Case Studies.....	33
2.5 Survey.....	34
2.5.1 RACE for 2030 Theme B3 - survey of end users.....	34
2.5.2 Survey analysis.....	35
2.5.3 Sector insights.....	39
2.6 Discussion and Recommendations.....	44
2.6.1 Research gaps, barriers, and opportunities.....	47
2.6.2 Future research.....	48
<b>3 Technology Overview.....</b>	<b>50</b>
3.1 Introduction.....	50
3.2 Hybridisation.....	50
3.3 Green Fuels.....	52

## Electrification & Renewables to Displace Fossil Fuel Process Heating

3.4	High TRL Technologies .....	53
3.4.1	Energy efficiency .....	53
3.4.2	Solar Thermal and Other Renewable Energy Technologies.....	60
3.4.3	Energy storage.....	62
3.5	Mid-TRL Technologies.....	64
3.5.1	Energy efficiency .....	64
3.5.2	Solar Thermal Technologies .....	66
3.5.3	Energy storage.....	67
3.6	Low-TRL Technologies.....	72
3.6.1	Energy Efficiency .....	72
3.7	Conclusions .....	73
3.7.1	Research gaps, barriers, and opportunities.....	76
4	Market Potential .....	77
4.1	Introduction .....	77
4.2	Uptake Scenario Modelling.....	78
4.2.1	Assumptions and limitations .....	79
4.3	Manufacturing and Processing .....	81
4.3.1	Alumina and other non-ferrous metals .....	81
4.3.2	Wood and wood products.....	85
4.3.3	Pulp and paper .....	94
4.3.4	Additional manufacturing and processing industries .....	100
4.4	Food and Agriculture .....	101
4.4.1	Dairy Processing .....	101
4.4.2	Meat Processing.....	108
4.4.3	Beer Processing .....	113
4.4.4	Food & Agriculture: Discussion.....	116
4.5	Commercial Buildings: Healthcare Facilities and Hotels.....	118
4.5.1	Introduction .....	119
4.5.2	Renewable Energy Technologies for Heating Demand in Healthcare and Hotels.....	121
4.5.3	Uptake Scenario: Healthcare and Hotels .....	123
4.6	Market Potential Summary.....	128
5	Barriers.....	133
5.1	Introduction .....	133
5.2	Barrier Methodology.....	133
5.2.1	Barrier categorisation.....	133
5.2.2	Barriers' review process .....	135

## Electrification & Renewables to Displace Fossil Fuel Process Heating

<b>5.3</b>	<b>Barriers to Electrification and Renewables in Industries</b> .....	<b>136</b>
5.3.1	Technology integration.....	136
5.3.2	Costs .....	139
5.3.3	Impacts on the grid.....	145
5.3.4	Regulations, policies, and standards .....	161
<b>5.4</b>	<b>Knowledge, Skills, Tools, Training, Accreditation and Culture</b> .....	<b>168</b>
5.4.1	Knowledge needed for the transition to non-fossil fuel heating technologies.....	169
5.4.2	Current skills inventory for main non-fossil fuel heating technologies.....	171
5.4.3	Current skills inventory for each success factor across each market participant .....	172
5.4.4	Gap analysis in skills across each market participant .....	173
5.4.5	Public awareness for non-fossil fuel process heating alternatives .....	174
5.4.6	Tools .....	174
5.4.7	Cultural barriers across industry sectors .....	174
5.4.8	Accreditation .....	175
5.4.9	Recommended pathways to address deficiencies in education and training, accreditation, regulation, and cultural barriers .....	175
<b>5.5</b>	<b>Insufficient data</b> .....	<b>176</b>
<b>5.6</b>	<b>Case study: Barriers for heating electrification in the healthcare sector</b> .....	<b>176</b>
5.6.1	Healthcare heating electrification barriers.....	177
5.6.2	Healthcare heating electrification enablers .....	182
<b>5.7</b>	<b>Discussion and Recommendations</b> .....	<b>183</b>
5.7.1	Barriers and challenges .....	183
5.7.2	Opportunities and recommendations to overcome barriers.....	184
<b>6</b>	<b>Industrial process heat decarbonisation: Path to impact</b> .....	<b>187</b>
6.1	Quantitative key performance indicators.....	189
<b>7</b>	<b>References</b> .....	<b>190</b>
Appendix A: Market Status Survey Sample.....		203
Appendix B: Summary of Uptake Scenario Modelling Data .....		214

## List of Figures

Figure 1. Percentage of heat use for manufacturing by temperature range and sector. ....	4
Figure 2. Percentage of low/medium temperature heat use for manufacturing by temperature range and sector. ....	4
Figure 3. Percentage of heat use for food processing, agriculture, forestry and fishing by temperature range and sector .....	5
Figure 4. Typical process summarising, (a) mapping unit operation, (b) heat intensity and technology landscape. ....	7
Figure 5. Process flow diagram legend .....	7
Figure 6. Australian bauxite deposits, operating mines, alumina refineries, and aluminium smelters 2018 [1, 2]. ....	8
Figure 7. Status for alumina and non-ferrous metals sector [2, 6], ANZSIC Subdivision 21, under division C (manufacturing), groups 213 and 214 .....	9
Figure 8. Typical bauxite to aluminium pathway process flow diagram through Bayer and Hall-Hérault processes. ....	10
Figure 9. Aluminium production overview, (a) simplified block flow diagram showing key heating ranges and relative temperature/energy intensity, (b) for medium temperature heating. ....	11
Figure 10. Location of wood and wood-based products industries [3] .....	11
Figure 11. Status for wood and wood-based products [2, 6], ANZSIC Subdivision 14, under division C (manufacturing), groups 141 and 149 .....	12
Figure 12. General process diagram for log processing and drying. ....	13
Figure 13. Lumber processing overview, (a) simplified block flow diagram showing key heating methods and their relative temperature/ energy intensity, (b) for medium temperature heating. ...	14
Figure 14. Location of pulp and paper manufacturing industries [2] .....	14
Figure 15. Status for pulp and paper [2, 6], ANZSIC Subdivision 15, under division C (manufacturing), groups 151 and 152 .....	15
Figure 16. General process diagram for kraft chemical pulping. ....	16
Figure 17. Kraft pulping overview, (a) simplified block flow diagram showing key heating consumers and their relative temperature/ energy intensity, (b) for medium temperature heating. ....	17
Figure 18. General process diagram for paper making.....	17
Figure 19. Papermaking overview, (a) simplified block flow diagram showing key heating consumers and their relative temperature/ energy intensity, (b) for medium temperature heating. ....	18
Figure 20. Location of food and beverage sites and their volume of heat use [2] .....	19
Figure 21. Status for food products and beverage manufacturing [2, 6], ANZSIC Subdivision 11 and 12, under division C (manufacturing), groups 111-119 and 121 .....	19
Figure 22. General process diagram for dairy processing. ....	20
Figure 23. Dairy processing overview, (a) simplified block flow diagram showing key heating consumers and their relative temperature/ energy intensity, (b) for medium temperature heating. ....	21
Figure 24. General process diagram for red meat processing.....	22
Figure 25. Meat processing overview, (a) simplified block flow diagram showing key heating consumers and their relative temperature/ energy intensity, (b) for medium temperature heating. ....	23
Figure 26. General process diagram for beer processing .....	24
Figure 27. Brewery overview, (a) simplified block flow diagram showing key heating consumers and their relative temperature/ energy intensity, (b) for medium temperature heating. ....	25
Figure 28. Hospitals overview (a) sites on the map of Australia (SA2: statistical areas level 2)[96], (b) other important information .....	26
Figure 29. A major Brisbane hospital hot water system process flow diagram .....	27

Figure 30. Relative temperature and energy intensity for hospitals .....	28
Figure 31. Residential aged care overview (a) sites on the map of Australia[105], (b) other important information .....	28
Figure 32. A typical aged care hot water system process flow diagram .....	29
Figure 33. Relative temperature and energy intensity for residential aged care facilities .....	30
Figure 34. Status for hotels in Australia as at June 2016 [114, 115].....	30
Figure 35. A typical hotel hot water system process flow diagram.....	31
Figure 36. Relative temperature and energy intensity for Australian hotels .....	32
Figure 37. Survey sites by sector.....	35
Figure 38. Number of sites per state .....	36
Figure 39. Number of sites by business size .....	36
Figure 40. Financial mechanisms used for determining economic viability of technical projects .....	38
Figure 41. Hierarchy of renewable energy use by technology for 100% renewable energy solution for end user. ....	51
Figure 42. Classification of different heat pumps, adapted from Wu et al. [143]......	53
Figure 43. Example of an ammonia high-temperature heat pump manufactured by Mayekawa [144]. .....	54
Figure 44. Alfa Laval Packinox heat exchanger [152].....	57
Figure 45. New heat exchanger technology: PCHE diffusion bonded (LHS, Alfa Laval), microtube shell/tube (RHS, Mezzo Technologies) [154, 155]. ....	57
Figure 46. Mobile TES from waste heat source [158].....	58
Figure 47. Small batch microwave oven from Pueschner (LHS) Continuous microwave system from Pueschner (RHS) [163, 164]. ....	60
Figure 48. Modular TES technology from Energy-Nest [173]. ....	63
Figure 49. Picture of the Johnson Controls /EDF heat pump [150]. ....	65
Figure 50. Schematic and thermal image of the silicon carbide pyrolyzer by Serio et al [179].....	66
Figure 51 Photograph of the evacuated tube air heater [181].....	67
Figure 52. CCT Energy Storage’s thermal battery [188].....	69
Figure 53. 1414 Degrees’ biogas thermal energy storage system [201]. ....	69
Figure 54. Overview of the storage test facility with screw heat exchanger with two shafts in front, two transport screws, and the tank for solid PCM in the back [194]. ....	70
Figure 55. Left: High-temperature test facility; Right: auger melting rig at the University of South Australia [195].....	70
Figure 56 Pilot plant experimental facility built at the University of Lleida [196] .....	71
Figure 57. Integration scheme of the moving bed pilot plant into DLR’s thermochemical test bench [199]. ....	71
Figure 58. Shows an electrocaloric system. An applied electric field is applied causing an increase in temperature [210]. ....	73
Figure 59. Example technology uptake rate based on a logistic innovation diffusion model. Adapted from [213]. ....	78
Figure 60. Use of MVR and renewable electricity to replace natural gas fired steam boiler and generator [216].....	82
Figure 61. Projected BaU scope 1 equivalent CO <sub>2</sub> emissions and reduction in emissions as a result of accelerated development of MVR steam supply technology for alumina refining. <sup>1</sup> 2035 emissions reduction target based on a 50% reduction in emissions associated with process heat below 150 °C relative to 2019 levels. Heat is currently supplied to these processes between 150 °C and 250 °C....	83
Figure 62. Net change in fossil fuel energy cost for Australian alumina refining relative to 2019 levels. .....	84

Figure 63. Possible implementation of solar kiln with waste heat temperature boosting/backup. ....	87
Figure 64. Implementation of a heat pump dehumidifier kiln with onsite solar PV. Onsite solar PV could also be replaced with grid electricity from renewable sources. ....	88
Figure 65. Implementation of a CHP unit powering a HP-D kiln and providing auxiliary heating. (a) Heat pump + desiccant dehumidifier. (b) Direct heat pump dehumidifier. ....	89
Figure 66. Business as usual projection of scope 1 equivalent CO <sub>2</sub> emissions from fossil fuel combustion in the timber drying process including potential reductions in emissions due to investment in energy saving upgrades. <sup>1</sup> 2035 emissions reduction target is based on a 50% reduction in heat use below 150 °C with respect to 2019 levels. Heat is currently supplied to this process between 150 °C and 250 °C. ....	92
Figure 67. Projection of accelerated emissions reduction through to 2035. Emission levels are scope 1 equivalent CO <sub>2</sub> emissions from fossil fuel combustion in the timber drying process. <sup>1</sup> 2035 emissions reduction target is based on a 50% reduction in heat use for lumber drying with respect to 2019 levels which translates to 15% reduction in overall emissions from process heating. ....	93
Figure 68. Projected market penetration of fossil fuel displacing investment options within the timber drying sector: (a) market penetration based on expected uptake rates for <100% renewable investment options. (b) effect of limiting investment in <100% renewable investment options. ....	93
Figure 69. Net change in fossil fuel energy cost for Australian timber drying relative to 2019 levels. ....	93
Figure 70. Energy supply and demand for the kraft chemical pulping process and the potential for decarbonisation of process heat through decoupling heat and electrical energy supply. ....	95
Figure 71. Opportunities for reduction in steam demand within the Kraft chemical pulping process. <sup>1</sup> Based on performance of similar heat recovery system trialled in paper manufacturing process [229]. ....	97
Figure 72. Opportunities for heat recovery in the paper manufacturing process. ....	98
Figure 73. Projection of BaU and accelerated reduction in scope 1 equivalent CO <sub>2</sub> emissions for the pulp and paper industry, including the expected impact of a major EfW project planned for completion in 2024 [230]. <sup>1</sup> 2035 emissions reduction target assumes that decarbonisation of process heat below 150 °C will effectively decarbonise the entire range of temperatures for process heat and therefor represents a 50% reduction in scope 1 emissions for the entire industry, calculated with respect to 2019 levels. ....	99
Figure 74. Net change in fossil fuel energy cost for Australian pulp and paper industry relative to 2019 levels. ....	99
Figure 75. Australian production of milk powder (Dairy Australia, 2021). ....	102
Figure 76: Projected scope 1 GHG emission reduction up to 2035 for milk powder production under BAU and ACL scenarios. ....	105
Figure 77: The overall new technology market penetration in dairy processing under BAU and ACL scenarios. ....	106
Figure 78: Projected scope 1 GHG emission reduction up to 2035 for overall dairy processing under BAU and ACL scenarios. ....	106
Figure 79: Net change in annual fossil fuel energy costs for the dairy processing sector relative to 2019 levels. ....	107
Figure 80: Australia's red meat production since 2000 [238]. ....	109
Figure 81: Projected scope 1 GHG emission reduction up to 2035 for meat processing under BAU and ACL scenarios. ....	111
Figure 82: The overall new technology market penetration in meat processing under BAU and ACL scenarios. ....	111
Figure 83: Net change in annual fossil fuel energy cost for the meat processing sector relative to 2019 levels. ....	112

Figure 84: The overall new technology market penetration in beer production under BAU and ACL scenarios. ....	115
Figure 85: Projected scope 1 GHG emission reduction up to 2035 for beer production under BAU and ACL scenarios. ....	116
Figure 86: Net change in annual fossil fuel energy costs relative to 2019 levels. ....	116
Figure 87: Annual energy consumption and floor area of healthcare buildings (1999-2020) (derived from Department of Climate Change and Energy Efficiency, 2021). ....	119
Figure 88: Natural gas for end use at Australian healthcare buildings (1999-2012) (derived from Department of Climate Change and Energy Efficiency, 2021 ). ....	119
Figure 89: Annual energy consumption and floor area at Australian Hotels (1999-2020) (derived from Department of Climate Change and Energy Efficiency, 2021). ....	120
Figure 90: Natural gas for end use at Australian Hotels (1999-2012) (derived from Department of Climate Change and Energy Efficiency, 2021). ....	121
Figure 91: Renewable technology uptake and impacts on carbon and energy savings for Australian healthcare buildings. ....	125
Figure 92: Net change in fossil fuel energy cost for Australian healthcare buildings relative to 2019 levels. ....	125
Figure 93: Renewable technology uptake and impacts on carbon and energy savings for Australian hotels. ....	127
Figure 94: Net change in annual fossil fuel energy cost for the Australian hotel sector relative to 2019 levels. ....	128
Figure 95: Summary of reduction in fossil fuel energy costs in 2035 relative to 2019 levels for the different sectors considered in the present analysis for both the business-as-usual and accelerated scenario. Note that a negative value shows an increase in cost. ....	129
Figure 96: Summary of reduction in annual greenhouse gas emissions in 2035 relative to 2019 levels for the different sectors considered in the current analysis for both the business-as-usual and accelerated scenario. Note that negative values show an increase in emissions. ....	129
Figure 97: Reduction in CO <sub>2</sub> equivalent emissions from process heat for all the major sectors considered in this report under the accelerated scenario relative to business as usual. ....	130
Figure 98: Reduction in annual fossil fuel cost from process heat for all the major sectors considered in this report under the accelerated scenario relative to business as usual. ....	130
Figure 99. An overview of the classification of barriers to the electrification & renewables of process heat. ....	134
Figure 100. Barriers mapping for the process heat electrification & renewables integration. ....	135
Figure 101. Maps showing (clockwise from top left): the distribution of electrical transmission lines; major oil and gas pipelines; relative annual mean wind- and wave-speeds; relative solar flux. Maps from [2]. ....	137
Figure 102. Cost of delivered heat in AUD with respect to temperature lift of industrial heat pumps as presented and as stated in [252]: At pump evaporator temperature = 55°C Efficiency of heat pump cycle is 65% of thermodynamic maximum Information intends to present trends and does not apply to all cases. ....	141
Figure 103. Residential and commercial (R&C) gas price projections [253] for Eastern Australia in AUD/GJ based on AEMO neutral scenario, that is under mid-point projections of economic growth resulting to an estimation of energy consumption. ....	141
Figure 104. Estimation of projected levelised cost of electricity (LCOE) for different technologies with ranges between 2- and 4-degrees climate ambition scenarios, 7% weighted average real cost of capital, and ranges of assumptions presented in the table of Figure 105 [254]. ....	142



Figure 105. Ranges for assumptions used to calculate the levelised cost of electricity for the above technologies [254] ..... 142

Figure 106. Projection of extended levelised cost of electricity with increasing share of variable renewable energy and supporting technologies such as storage [254] ..... 143

Figure 107. Indicative capital costs: installed cost per unit capacity of solar-thermal technologies versus temperature [249] ..... 144

Figure 108. Illustration of various scenarios explored in AEMO 2020 ISP [258]. ..... 146

Figure 109. Power system development in the NEM across different scenarios – Source: [258]..... 146

Figure 110. Electricity consumption in the National Electricity Market (NEM) in Australia as actual and forecasted [262]..... 147

Figure 111. Overview of the analysis of characteristics of the potentially electrified 'process heat' loads..... 148

Figure 112. Current 24-hour load profile in Australia (on Tuesday, 19 January 2021[263]: a) Total b) States. .... 150

Figure 113. Time series for Australian average temperature change from 1910 to 2090 [264]..... 153

Figure 114. Opportunities with the electrification of process heat [267]. ..... 155

Figure 115. Total electricity demand in each state combined with the amount generated by PV. Source: [267] ..... 158

Figure 116. Annual energy reduction of each sector during peak load hours of the power grid..... 159

Figure 117. Annual cost saving for each sector after demand response..... 160

Figure 118. Example of an industrial demand response providing fast frequency response in the Electric Reliability Council of Texas (ERCOT) under different penetrations of renewable energy, as included in [280]. Source: [282]..... 162

Figure 119. The process of the demand response mechanism as set by AEMC [284] ..... 163

Figure 120. Connection of DER as per current network rules ..... 165

Figure 121. Controlled load shedding as occurred in previous years in Australia [294] ..... 166

Figure 122. CO<sub>2</sub> emission by configuration cases ..... 179

Figure 123. Solutions mapping for the electrification & renewables integration of process heat. ... 186

## List of Tables

Table 1. Australian hospital summary statistics (2017-2018) [99-101] .....	26
Table 2. RAC summary statistics (2019-2020) [105-108].....	29
Table 3. Hotel summary statistics as at June 2016 (collated from[114]).....	31
Table 4. Industry Survey - Sectors and ANZSIC Codes .....	34
Table 5. Diversity of sub-sections represented in responses .....	35
Table 6. Summary of energy information across three broad sectors .....	39
Table 7. Pulp and paper low and medium temperature heat processes.....	40
Table 8. Snack foods medium temperature heat processes.....	41
Table 9. Pet food manufacture low temperature heat processes.....	41
Table 10. Meat processing low-mid temperature heat processes .....	42
Table 11. Meat processing potential opportunities .....	42
Table 12. Beer manufacturing process heat summary .....	43
Table 13. Beer manufacturing potential opportunities .....	43
Table 14. Commercial building process heat summary .....	44
Table 15. An overview of discussed sectors for process heating in this report.....	45
Table 16. List of available high temperature heat pump manufacturers.....	55
Table 17. Summary of heat exchanger technology. ....	56
Table 18. Microwave, infrared and radio frequency heating systems available on market. ....	59
Table 19 Concentrated and Non-Concentrated Solar Thermal Energy Systems .....	61
Table 20. Summary of high TRL thermal energy storage technology global developments. ....	63
Table 21. Comparison of thermal and battery energy storage cost with the impact of COP.....	64
Table 22. Summary of mid-TRL thermal energy storage technology global developments.....	68
Table 23. Comparison of cooling technologies.....	73
Table 24. Summary of technologies investigated.....	74
Table 25: Values used to estimate reduction in greenhouse gas emissions and energy costs for both the business-as-usual and accelerated scenarios. Greenhouse gas emission factors obtained from the Department of Industry, Science, Energy, and Resources [214], while gas prices were obtained from the Australian Energy Market Operator [215]. All other energy costs are from ITP Thermal Pty Ltd [2]. .....	79
Table 26. Renewable energy technologies for heating demand in wood drying .....	86
Table 27. Logistic function parameters and emissions reduction potential for the BaU and accelerated uptake scenarios .....	91
Table 28. Technology options with the potential to electrify dairy process. ....	104
Table 29. Logistic function parameters for business-as-usual and accelerated scenarios for dairy processing .....	105
Table 30: Technology options with the potential to electrify/decarbonate meat processing.....	110
Table 31: Technology options with the potential to electrify/decarbonate beer production. ....	114
Table 32: Technology options with the potential to electrify healthcare and hotel process heating. .....	123
Table 33: Logistic function parameters for renewable energy uptake in healthcare and hotel buildings.....	124
Table 34. Estimated renewables and electrification opportunities by sectors .....	149
Table 35. DR flexibility opportunities for four sectors.....	159
Table 36 The level of thermal energy storage for the case study .....	161
Table 37 Skill inventory for high TRL technologies .....	172
Table 38 Skill inventory in non-fossil fuel heating solutions.....	172

## Electrification & Renewables to Displace Fossil Fuel Process Heating

Table 39 Major and minor knowledge gaps impeding the uptake of non-fossil fuel process heating alternatives. ....	173
Table 40. Calculation for technologies comparison.....	178
Table 41. Quantitative key performance indicators required to meet 2035 accelerated scenario targets. Metrics in 2025 and 2030 correspond to milestones for impact. ....	189
Table 42: Summary of emission reduction from process heat for all sectors investigated in the current analysis for the accelerated scenario relative to business as usual.....	214
Table 43: Summary of fossil fuel cost reduction from process heat for all sectors investigated in the current analysis for the accelerated scenario relative to business as usual.....	215

## 1 Introduction

The total energy consumption in Australia was 4390 PJ in 2018-2019 [1]. Although nearly half of Australia's energy consumption is related to liquid fuels for engines and transport, up to 30% of total energy (fuel) is used for heating ( $\approx 1050$  PJ delivered heat) [2]. Excluding heating for residential hot water and space heating, a considerable share of the energy used for heating is used by Australia's industries, with an estimated 750 PJ in 2018-2019.

The decarbonisation of heat is necessary to reduce greenhouse gas emissions and limit global warming. Australia, along with many other countries, has accepted the goal of working to reduce greenhouse gas emissions to limit global warming to less than 2 °C [2]. Fossil fuel use in manufacturing alone contributes approximately 8% of Australia's greenhouse gas emissions and costs businesses approximately 8 billion AUD annually. Reduction of process heating costs are crucial for businesses to remain competitive.

Australia is not unique in the need, and intention, to shift away from fossil fuels for process heating and increase the uptake of renewable technologies. Industrial process heat is responsible for 7.5 Gt of CO<sub>2</sub> emissions annually, which accounts for 21% of all global emissions [3]. Analyses from the International Energy Agency (IEA), support phasing out the sale fossil fuel boilers by 2025 and meeting 50% of all heating demand by heat pumps by 2045, supplemented by biomass and hydrogen combustion as well as direct electric heating [4]. In the United States of America, approximately 30% of total heat is produced below 100 °C, with a further 30% produced between 100 – 400 °C [5], presenting significant opportunities for low temperature heating technologies.

Strategies to decarbonise heat have been proposed in an Australian context, where gas and coal are the two dominant fuel sources for process heat [2]. Although multiple technologies are available, they each present opportunities, limitations and barriers depending on application and the required process temperature. This opportunity assessment report has been produced for the Reliable Affordable Clean Energy for 2030 Cooperative Research Centre (RACE for 2030 CRC) Theme B3 "Electrification and Renewables to Displace Fossil Fuel Process Heating". The report focuses on electric and renewable process heating technologies suitable to deliver "low temperature heat" below 150 °C, based on the actual requirements of the process, service or product, rather than the temperature at which existing systems supply heat.

### 1.1 Report Structure

The report is broken down into four major sections: the Market Status, Technology Overview, Market Potential and Barriers analyses.

The Market Status section analyses overall process heat usage in Australian industry, with a focus on required heat delivered between 50 – 150 °C. Seven sectors are taken as case studies from the manufacturing and processing, food and agriculture industries and typical types of commercial buildings, based on the most significant users of heat in this temperature range. This is then followed by a summary of Australian and global leaders in decarbonising heat usage at similar temperatures and the results of a survey of heat users in Australian industry.

The Technology Overview section follows the Market Status, and focusses on available and developing technologies. Methods of hybridisation, different green fuels, solar energy, energy storage and electric heating technologies, including heat pumps, are discussed here. In this, technologies are sorted by their technology readiness level, to provide guidance on what technologies may be expected in the future and those which are "market ready".

## Electrification & Renewables to Displace Fossil Fuel Process Heating

The Market Potential section provides uptake scenarios for the seven case studies, aligning the sectors with potential technologies to displace fossil fuel combustion. The impact of different technology uptake rates is compared through the analyses of equivalent CO<sub>2</sub> emissions and 'fuel' costs in both business as usual (BaU) and accelerated market penetration scenarios.

The Barriers section follows the analyses of the market and technologies to categorise, analyse, discuss and present potential solutions to, obstacles and challenges which may hinder the decarbonisation of the low temperature process heat. This section is finalised with a more detailed analysis of one case study before finishing with opportunities and recommendations.

Finally, following these major sections, a table of impacts, milestones and proposed key performance indicators are presented. These stem from with the barriers and research questions raised throughout the report and are directly align with projects presented in the research roadmap at the front of the report.

## 2 Market Status

### 2.1 Introduction

This Market Status section focusses on identifying which are the key unit operations in the major processes that contribute to significant greenhouse gas (GHG) emissions, with a focus on the temperature range 50-150 °C.

Information around total estimated heating requirements for various sectors is supplied in a recent commissioned by ARENA (“the ARENA report”) which derives data from emissions reported in the National Pollutant Inventory (NPI) data [2, 6]. This information was used to identify process industries that significantly use heat in the range 50-150 °C. Several sectors were excluded for further detailed review on the basis that they have minimal use of process heat in this temperature range, e.g., iron and steel. This study did not consider the opportunity in processes using high temperature heat where there is a small proportion low temperature heat (<150 °C) that could be heated supplied renewably. Apart from decarbonisation potential, other factors considered included (i) uniformity of processing, (ii) the number of affected sites, and (iii) perceived likelihood to transition within 10 years. On this basis, oil and gas were not reviewed, for example.

Identifying the industries where processing, and therefore low temperature process heat, is relatively uniform allows targeting of individual technologies to be applied across the sector. Food industries as a sector, for example, mostly use low-temperature heating (mostly 100-150 °C), for applications such as pasteurisation, evaporation and drying, but processing is quite fragmented by product type.

### 2.2 Market Status Methodology

Processes contributing significantly to Australia’s low temperature process heat were selected (Section 2.2.1) and subsequently reviewed (Section 2.2.2).

#### 2.2.1 Process selection

##### 2.2.1.1 Manufacturing sector

Figure 1 shows heat use by Australian manufacturing sectors based on reported data in the Australian Energy Statistics (AES) 2018-2019 [1] and the ARENA report (Renewable Energy Options for Industrial Process Heat) [2]. The AES provides the total energy consumption. Excluding oil and electricity share in the AES, the total energy consumption gives a similar estimation for heat use as that given in the ARENA report <sup>1</sup>[2]. Process heating is then broken down into four different temperature ranges based on the processing temperature required (as opposed to the steam supply temperature), namely: <150 °C, 150 °C-250 °C, 250 °C-800 °C and >800 °C. High temperatures (>800 °C) account for the majority of total heat use.

Most of this high temperature heat is consumed by minerals/metals processing industries (predominantly non-ferrous metals), with the remainder being chemical, cement, ceramic and glass manufacture with a small portion used in metal fabrication.

In contrast, the process heating at temperatures below 150 °C (which is the focus of this study) is relatively small in comparison to the other temperature ranges.

---

<sup>1</sup> For ammonia, in addition to oil and electricity 70% of the natural gas contribution was also ignored as a significant amount of gas is used as a feedstock in this sector as well as for heat.

## Electrification & Renewables to Displace Fossil Fuel Process Heating

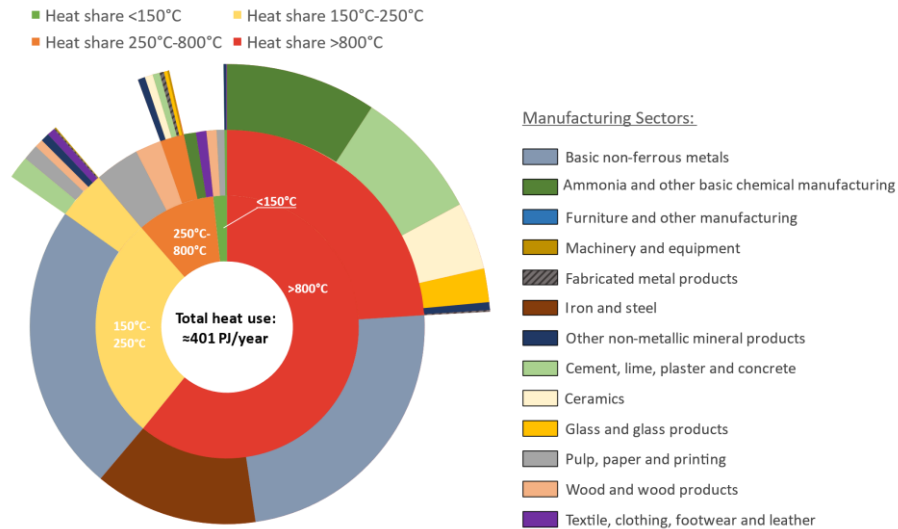

Figure 1. Percentage of heat use for manufacturing by temperature range and sector.

Figure 2 provides a closer look for low/medium temperature heating below 250 °C. The majority of heat usage between 150 °C and 250 °C is consumed by the non-ferrous metal refining sector—particularly alumina uses this heat in operations such as evaporation. Subsequently, alumina production was selected as a promising manufacturing process in the current investigation. In addition to the non-ferrous metals sector, manufactured wood products, and pulp and paper use a large proportion of the remaining heat, both above and below 150 °C. This was the reason for having a closer look at process heating for the pulp and paper industry and wood processing sector. The kraft pulping process has been chosen among the different pulping methods (e.g., mechanical pulping) due to the high intensity of heating required for turning wood fibres into pulps [7]. Paper processing, as a significant gas user, was also selected for more investigation. Finally, lumber drying – which significantly uses low-temperature heating in wood and wood products also warranted discussion in this report.

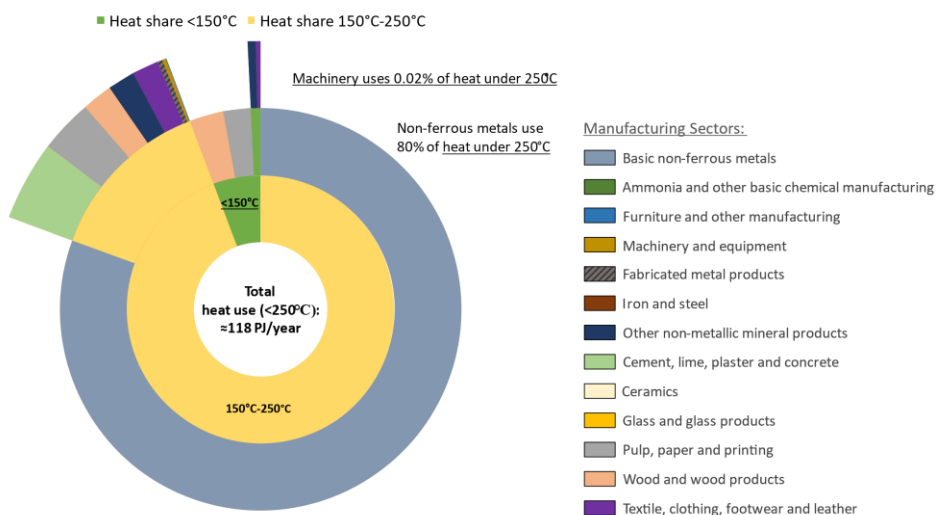

Figure 2. Percentage of low/medium temperature heat use for manufacturing by temperature range and sector.

The cement and lime sector has a significant share for process heating in the 150-250 °C range. However, most of the low/medium temperature heating can be supplied by waste heat generated on-

site through high-temperature processes such as calcination ( $\approx 1450\text{ }^{\circ}\text{C}$ ) [8]. Subsequently, the cement and lime sector has not been investigated in this report. The textile sector has not been discussed due to the relatively lower amount of low-temperature heating ( $<150\text{ }^{\circ}\text{C}$ , see Figure 2) and also the relative lack of process uniformity.

### 2.2.1.2 Food processing, agriculture, forestry and fishing sectors

Figure 3 shows the process heat used by food processing, agriculture, forestry and fishing sectors in different temperature ranges. Unlike the manufacturing sectors, lower temperature process heat use, between  $150\text{ }^{\circ}\text{C}$  and  $250\text{ }^{\circ}\text{C}$ , combined with process heating below  $150\text{ }^{\circ}\text{C}$ , accounts for the vast majority of the total demand. The food processing sector also has some process heating in the range of  $250\text{ }^{\circ}\text{C}$  to  $800\text{ }^{\circ}\text{C}$ . The agricultural sector does not use any heat at higher temperatures. Almost all the process heat use is consumed in the food processing sector rather than agriculture, forestry, and fishing which makes the food sector an opportunity for low-temperature heating and electrification. Dairy processing and meat processing are amongst the biggest consumers of energy in the food industry and so have been reviewed in this report [2]. The processing uniformity of these subsectors was another factor for selection. For the same reason, beer processing has been chosen for further electrification analysis in this report owing to its process uniformity. Identifying which sub-sectors within the food and beverage processing industries that are using much of this heat, have a uniform process and that are not already utilising either electricity or renewables, will indicate which specific industries represent the greatest scope for carbon reduction. The sugar industry was excluded from the analysis since almost all its heat is provided by biomass (sugarcane) [2]. According to the AES, most of the energy used in agriculture, forestry and fishing is for transportation and vehicles with negligible heating demand in comparison with the food sector. The uniformity of the process heating is another issue for analysing process heat use in agriculture, forestry, and fishing sector, and has not been reported.

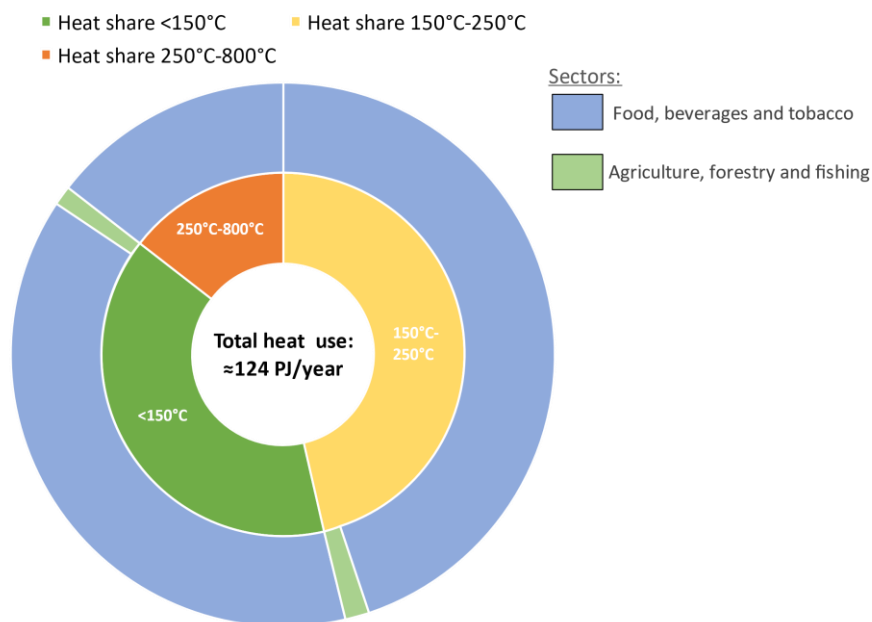

Figure 3. Percentage of heat use for food processing, agriculture, forestry and fishing by temperature range and sector

### 2.2.1.3 Commercial and services sector

In contrast with previous sectors, the reported information for the AES report's commercial and services sector is not fragmented into subsections that could be readily presented for comparison with



Figures 1-3. However, it is estimated commercial and services heating demand is  $\approx 61\text{PJ/year}^2$ . A significant share of heating demand goes for heating the commercial building using hot water, steam, and space heating. This report will also consider some significant commercial buildings such as hospitals, hotels, and aged care facilities to cover some essential parts of this sector.

### 2.2.1.4 Approach

These findings focus on providing an overview of the market status of process heating unit operations in manufacturing, processing (including agriculture-oriented processing), and the commercial and services sector. This identifies the status of low temperature process heating needs for key sectors, namely alumina and non-ferrous metals, pulp and paper, food and beverages (including dairy processing, industrial brewing, meat processing) and similar heating needs for hospitals, aged care facilities and hotels. The methodology for the assessment of market status is provided in Section 2.2.2, with key findings in Section 2.3.

Appendix A is a sample survey provided to industry representatives to address outstanding gaps in public data and literature. These were administered by A2EP through the Industry Reference Group. The results of the survey are provided in Section 2.4.

### 2.2.2 Process review

The objective in the process review was to identify key unit operations that significantly contribute to GHG emissions that have high potential to be mitigated. Once these key unit operations were identified, then the relative temperature ranges and contribution to overall process heat demand were estimated with a view to shortlisting key potential opportunities for further examination.

- Broad industry review. For each identified process, the first step was to review the general status of each industry, such as the total estimated heating used, the approximate location of sites, the uniformity of process, geographical location, and the number of employees. The employee numbers were obtained from the National Pollutant Inventory (NPI) report, which is sorted based on Australian and New Zealand Standard Industrial Classification (ANZSIC)[6].
- Generate a simplified Process Flow Diagram (PFD) for each typical process, highlighting unit operations with high potential for Greenhouse Gas (GHG) mitigation. This was achieved through public sources, such as academic literature and government reports. For this project, standard process engineering practice for PFD design was adjusted to communicate heating/steam streams and heat sinks for further evaluation by non-process engineers.
- Mass and energy balance. Preliminary mass and energy balances were performed to quantify the relative intensity of the low temperature heat requirement for each process, which is a key outcome of this work. These data are also communicated on the PFDs.
- Peak load. Most processes are designed such that all equipment is rated for a similar throughput capacity. As such, most processes operate continuously<sup>3</sup> which minimises production costs. Some specific processes operate in batch mode. An analysis of electrical peak load was not feasible due to insufficient information available in the open literature. It was also not elucidated from surveys.
- The key specified unit operations for each process was summarised in a block flow diagram (distinct from a PFD) and presented as a graph based on temperature and intensity *viz.* the example in Figure 4. This identifies the status of process heat demand for the process for

---

<sup>2</sup> Using the same method for estimation by excluding oil and electricity from AES total energy consumption in 2018-2019.

<sup>3</sup> Run 7 days of week, 24 hours per day.

## Electrification & Renewables to Displace Fossil Fuel Process Heating

further examination in other tasks in the Opportunity Assessment (notably Technology Overview, Market Potential, and Barriers sections).

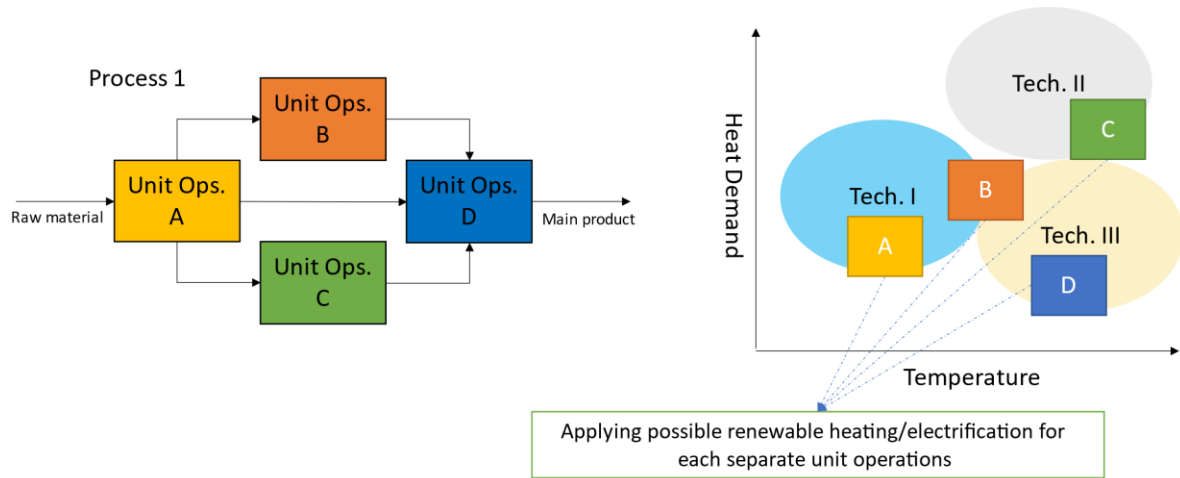

Figure 4. Typical process summarising, (a) mapping unit operation, (b) heat intensity and technology landscape.

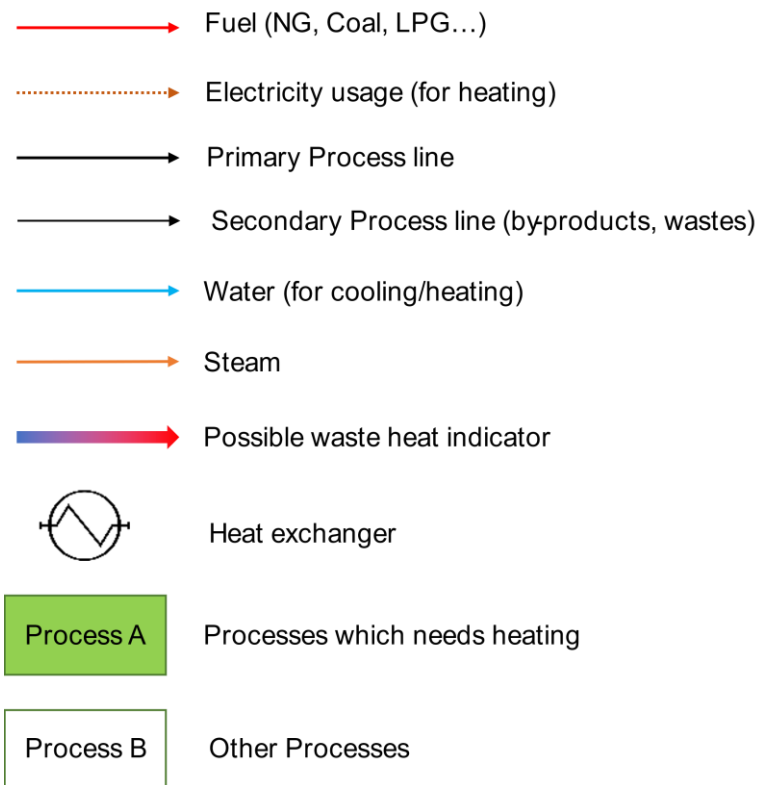

Figure 5. Process flow diagram legend

## 2.3 Market Status Review

### 2.3.1 Alumina and non-ferrous metals

#### 2.3.1.1 Background

Australia was the world's largest alumina exporter in 2018 (17 Mt) [9], and has five major bauxite mines, six alumina refineries (with the capability of producing  $\approx 20$  Mt/year), and four aluminium smelters. The locations of alumina-based plants and mines are provided in Figure 6 [9]. Australia is the world's largest bauxite producer by providing 96 Mt bauxite in 2018 [10].

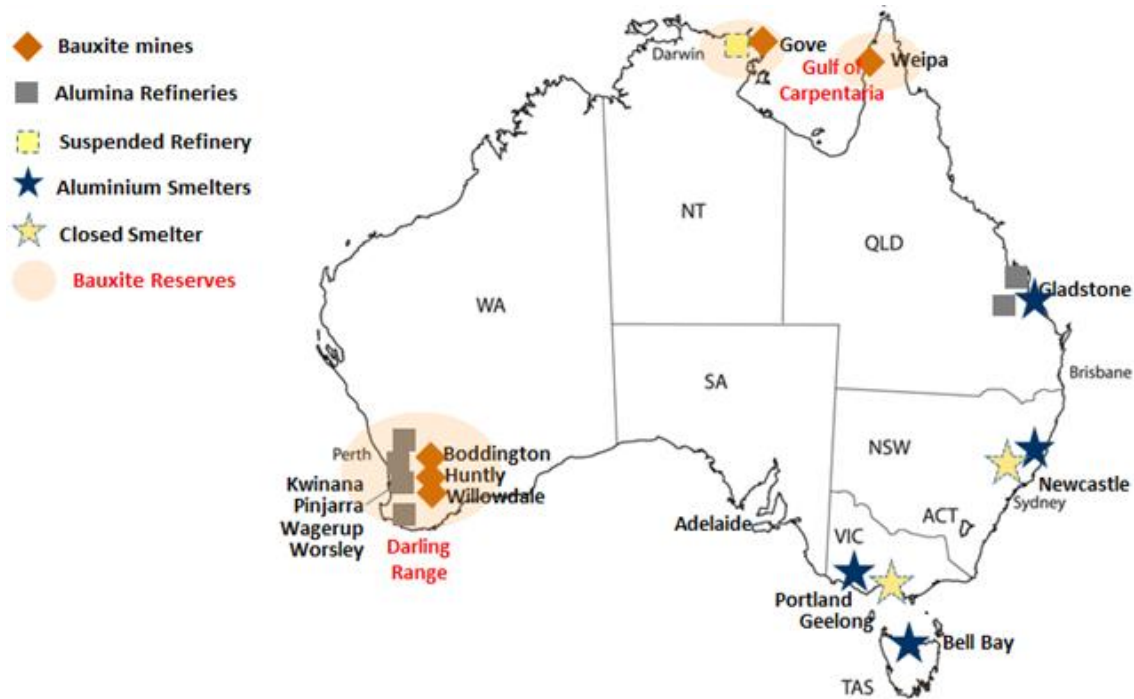

Figure 6. Australian bauxite deposits, operating mines, alumina refineries, and aluminium smelters 2018 [1, 2].

Similar to alumina, other non-ferrous metal processing has relatively uniform processing that requires significant thermal energy in high-temperature kilns, and medium temperature heating using low/high pressure steam for concentrating, dewatering, leaching, roasting, and refining[11]. According to the Australian Energy Update (September 2020) [1], alumina and non-ferrous metals use 333 PJ of energy, which is the highest energy consuming sub-sector in the manufacturing sector (31.7%). It also accounts for 5.4% of Australia's total energy consumption [1]. However, a large amount of energy is related to electricity usage in the smelting process. It was estimated that 30% of final energy consumption in Australia is used for process heating. The alumina and non-ferrous metals sector accounts for 16.7% of Australia's heating [2], i.e., 179 PJ/year of total heating (2018-2019).

A total of six refineries in Australia generated 2.8% of Australia's total greenhouse gas emissions and 27% of Australia's emissions in the manufacturing sector in 2017 [10]. Most of the emissions (almost 70%) are generated in the process of refining low-temperature bauxite for alumina refining (Bayer process), which could be potentially replaced by renewable energy [10]. Figure 7 provides the energy intensity and temperature status in this sector.

## Electrification & Renewables to Displace Fossil Fuel Process Heating

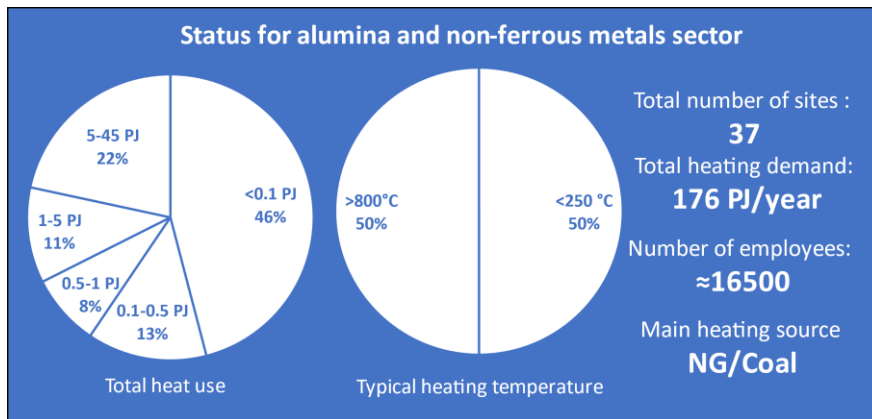

Figure 7. Status for alumina and non-ferrous metals sector [2, 6], ANZSIC Subdivision 21, under division C (manufacturing), groups 213 and 214

### 2.3.1.2 Process flow diagram and heating demand in Bayer process

Figure 8 provides the typical flow diagram for aluminium production [10, 12-19]. The Bayer process is commonly used for converting bauxite into alumina. The most important steps relevant to the opportunity assessment are as follows:

- Hydrothermal digestion of bauxite (140-180 °C)
- Clarification of aluminium-rich soda (100-105 °C)
- Evaporation of diluted soda (70-100 °C)
- Precipitation of alumina hydroxide (60-80 °C)
- Calcination of alumina hydroxide (950-1100 °C)

Converting alumina to aluminium occurs using the Hall-Héroult process [20]. In contrast with the Bayer process, the Hall-Héroult process is mostly dependent on electricity rather than heating.

## Electrification & Renewables to Displace Fossil Fuel Process Heating

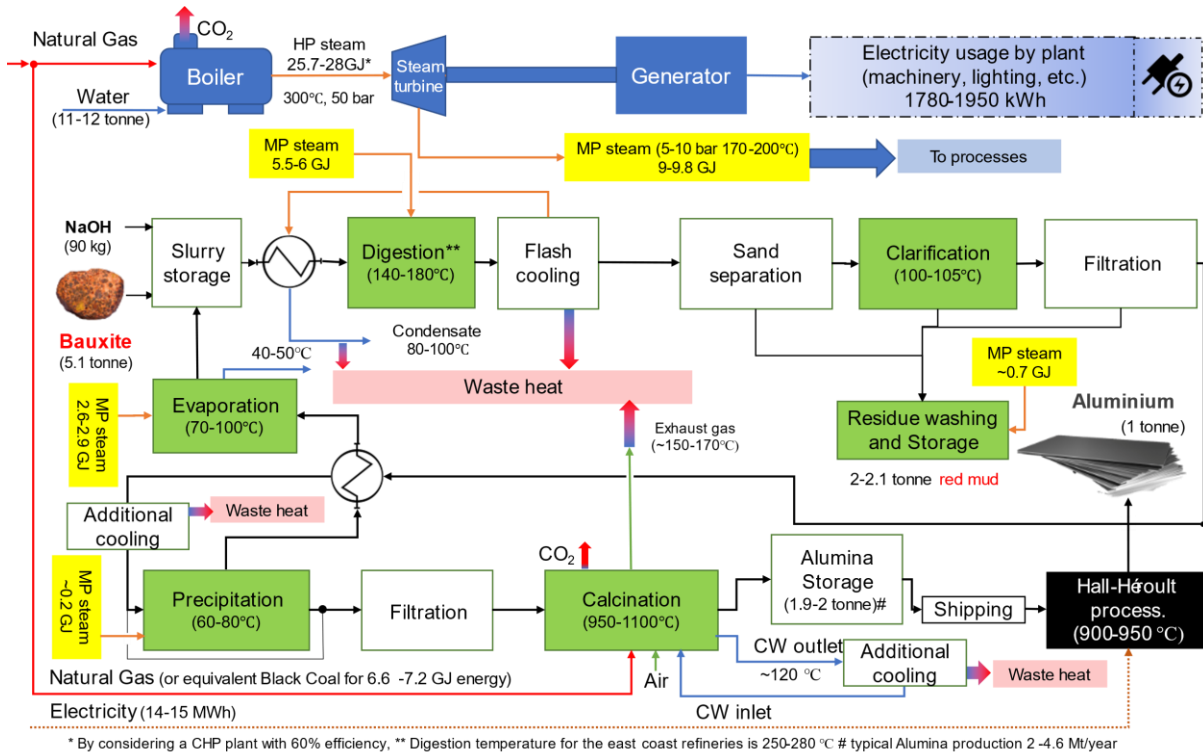

Figure 8. Typical bauxite to aluminium pathway process flow diagram through Bayer and Hall-Héroult processes.

The liquid loop of the Bayer process requires considerable heating for digestion and evaporation. The steam usage for plant heating is about 40-50% of total energy consumption in the Bayer process [2]. The rest of the energy is consumed for electricity generation (in the form of steam) and the calcination process (by direct combustion) to dry aluminium hydroxide to alumina at 1000-1100 °C. The combined Bayer and Hall-Héroult processes require 11-12 GJ/t and 14-15 MWh/t production of alumina and aluminium [21]. The evaporation demands for notable heating with the temperature lower than 150 °C. However, in the available public literature (e.g. ARENA report [2]) the share of low-temperature heating is negligible. This justifies the more in-depth analysis for low-temperature heating in the alumina and other non-ferrous metals sector.

### 2.3.1.3 Opportunities in aluminium industry

Figure 9 provides a simplified overview of the aluminium production in relation to energy and temperature demand. Natural gas is used in conventional boilers as the primary method for the steam generation. It should be mentioned that Queensland Alumina and Yarwun refineries, both in Gladstone in Queensland, and the Worsley refinery in WA use coal for steam raising and gas for other processes [2]. In recent years, using circulating fluidised bed (CFB) calciners reduced the total energy consumption for calcination using efficient heat recovery. However, the stack flow still includes gases at 150-170 °C, which cause up to 0.77 GJ/t heat loss [16]. In addition, the cooling water circuit in the calciner could lose energy by 0.35 GJ/t [16]. There are other sources of heat waste in the process which can be saved or used in electrification options such as mechanical vapour recompression (MVR) [22].

## Electrification & Renewables to Displace Fossil Fuel Process Heating

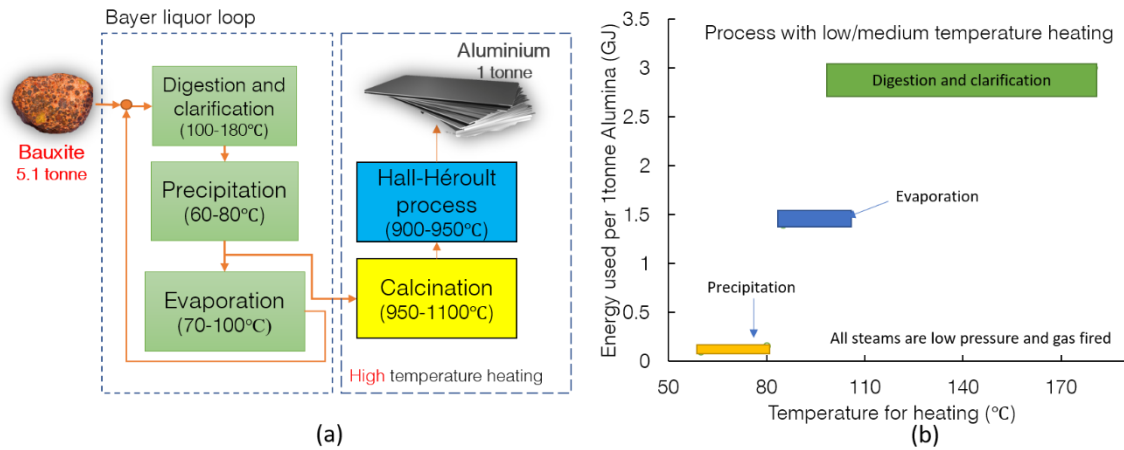

Figure 9. Aluminium production overview, (a) simplified block flow diagram showing key heating ranges and relative temperature/energy intensity, (b) for medium temperature heating.

### 2.3.2 Wood and wood processing

#### 2.3.2.1 Background

In total, Australia ranks as the seventh-largest country in terms of forest area. Approximately 3% of the world's forests are located in Australia, covering 17% of Australia's total land area [23]. Almost 2 million hectares are available for commercial application across Australia. More than 32 million cubic metres of logs were harvested in 2018-2019, with a value of 2.7 billion AUD for both export and wood processing [23, 24]. However, this value was increased to 24.8 billion AUD by processing wood to wood products [24]. 61% of logs volume consumption (13 million cubic metres) in 2018-2019 was for saw mills and wood veneers [24]. Figure 10 provides a general map view of timber and wood products manufacturers [25], which shows the numerous locations of operations in this sector.

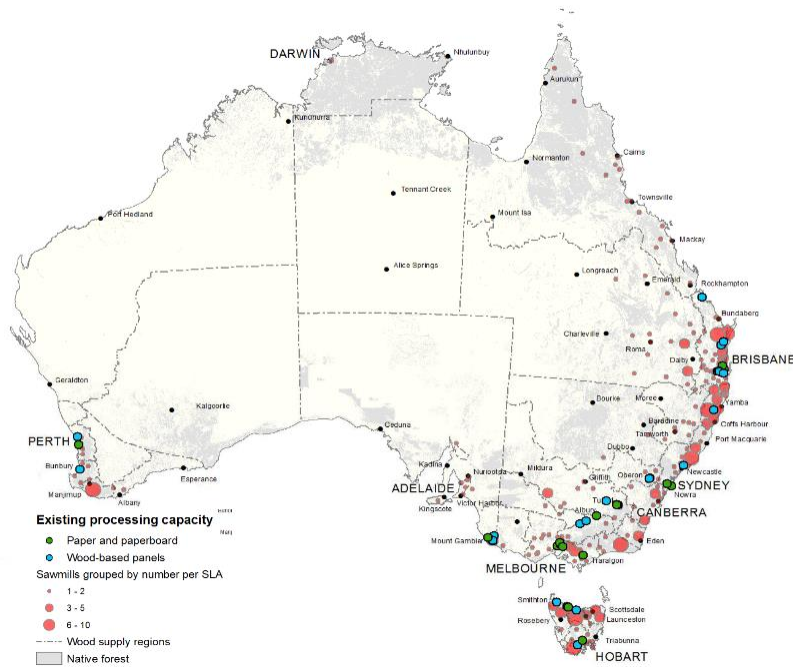

Figure 10. Location of wood and wood-based products industries [3]

## Electrification & Renewables to Displace Fossil Fuel Process Heating

According to the Australia and New Zealand Standard Industrial Classification (ANZSIC), wood and wood products are categorised under wood product manufacturing (Group 14). The subdivision of Forestry and logging (in A division) was not considered due to the small usage of process heating. Although there are plenty of sites, such as log sawmilling, timber dressing, and other product manufacturing such as wooden buildings, most low temperature heat (up to 150 °C) is consumed in the limited number of operations performing timber drying. Figure 11 provides the energy intensity and temperature status in this sector [2, 6]. In 2018-2019, 13 million cubic metres of wood was consumed in sawmill and veneer manufacturers with sales of more than 14.2 billion AUD, which is 60% of total sales in wood and wood-based products [24]. According to literature and the recent AES update, it can be estimated that wood and wood processing demand is 14.3 PJ/year [1, 2]. Drying lumber to produce value-added material is an expensive, time-consuming process and a bottleneck for wood processing [26]. Thermal energy for drying consumes up to 70% of the total energy for converting logs into dried value-added wood products [26].

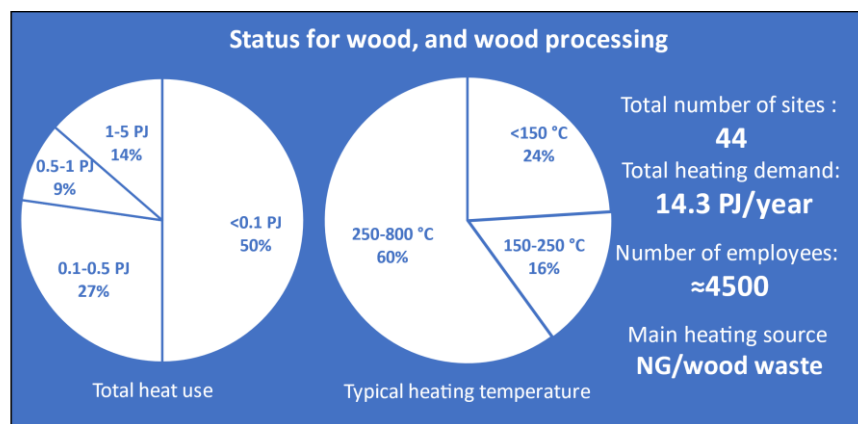

Figure 11. Status for wood and wood-based products [2, 6], ANZSIC Subdivision 14, under division C (manufacturing), groups 141 and 149

### 2.3.2.2 Process flow diagram and heating demand in Lumber processing

According to Australian standard AS 2796, the dried lumber or seasoned lumber should have 8-12% moisture (wet weight basis) [27]. This is the typical moisture content required for coastal Australia when used for indoor applications [28]. Figure 12 provides a typical process flow diagram of typical lumber processing [26-33]. The most important steps are as follows:

- Debarking (mostly electricity)
- Sawing and trimming (mostly electricity)
- Air drying /pre-drying (ambient temperature/20-38 °C )
- Kiln drying 40-75 °C (the only electrifying/renewable opportunity)

Electricity is the most important energy resource currently used in the debarking sawing stage. Pre-drying can reduce energy usage significantly by reducing the drying kiln capacity [32]. The air-drying uses only ambient conditions to dry. Sometimes, to reduce the processing time, forced air drying is used with the aim of minimal low-pressure steam (not more than 10% to total steam).

## Electrification & Renewables to Displace Fossil Fuel Process Heating

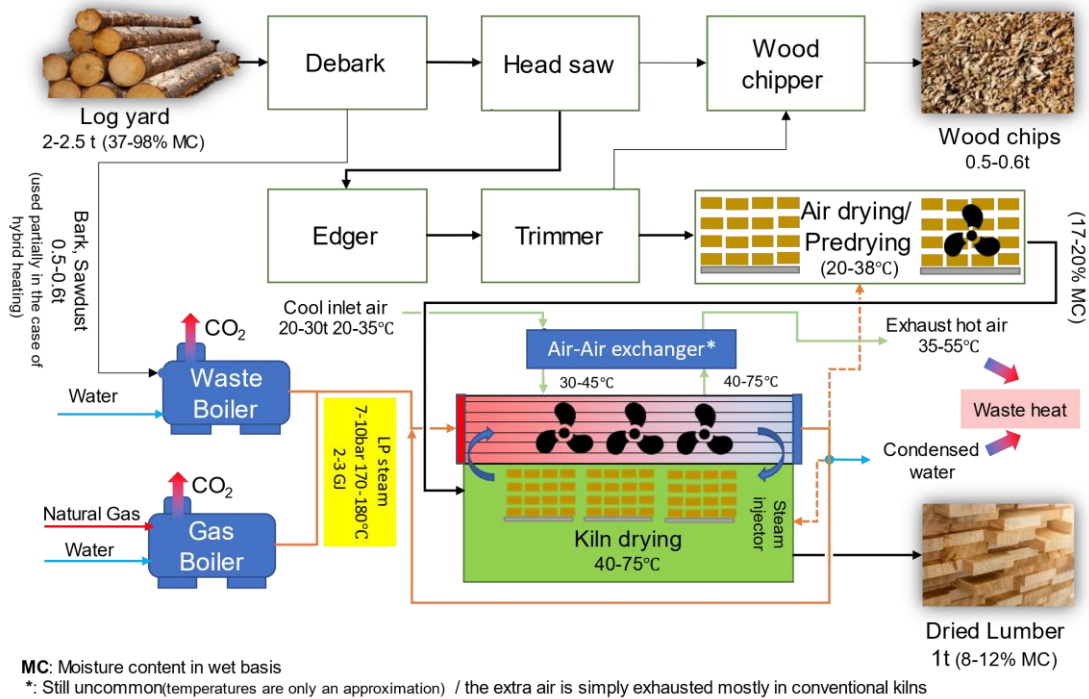

Figure 12. General process diagram for log processing and drying.

The most energy-consuming process is the main kiln drying process, which accounts for the total heat requirements and 70% of the total energy requirements. The steam-heated, internal fan compartment kiln is the most popular type of conventional kiln used across Australia [26, 27, 30, 31]. The typical energy demand could be estimated by 2-3 GJ/t of lumber [34-36].

### 2.3.2.3 Opportunities in wood processing

Figure 13 provides a simplified overview of the lumber processing in relation to energy and temperature demand. Low pressure steam is the main source of energy. The steam could be produced using either bark and wood waste or a natural gas boiler. An integrated kiln dryer could supply up to 50% of total required heating [36]. Conventional kiln drying loses a significant amount of energy by venting hot air, making the sawmill's energy cost up to 60% of total operating costs [37]. According to Redman [27], the conventional kilns in Australia can lose energy up to 65%, which could be reduced to 30% by using vacuum kilns. Adding an air-air exchanger for using the vented hot air (see Figure 12) could improve efficiency although is still relatively uncommon [34]. Other methods considered state-of-the-art include dehumidification of the kiln area by condensing water moisture on the cooling coil, wood waste gasification for process heat and electricity [38] and leveraging waste heat in a heat-pump aided system [39]. Conventional drying also consumes 90% of the total processing time [26].



## Electrification & Renewables to Displace Fossil Fuel Process Heating

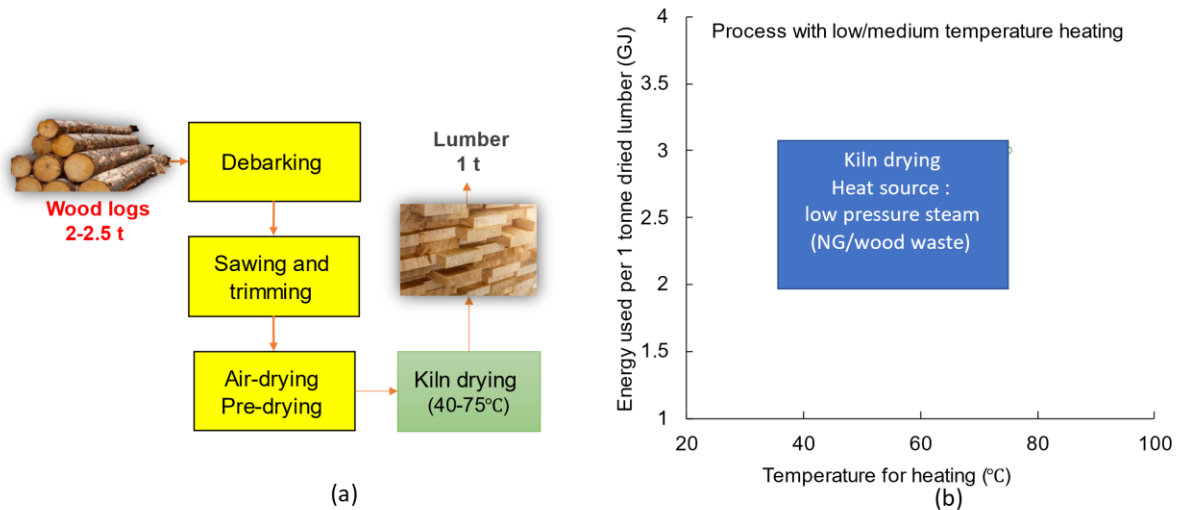

Figure 13. Lumber processing overview, (a) simplified block flow diagram showing key heating methods and their relative temperature/energy intensity, (b) for medium temperature heating.

### 2.3.3 Pulp and paper industry

#### 2.3.3.1 Background

The pulp and paper industry accounts for 29% of the total volume of harvested logs in 2018-2019 (6 million cubic metres) [24]. According to ANZSIC, the pulp and paper industry is categorised under group 15 of the manufacturing subdivision. Figure 14 provides the locations of Australia's pulp and paper mills [2]. The primary heat users in this sector are across 44 sites, which mostly use up to 0.5 PJ per year [2, 6] although several large pulp/paper factories use more than 0.5 PJ. More details are provided in Figure 15 [2, 6].

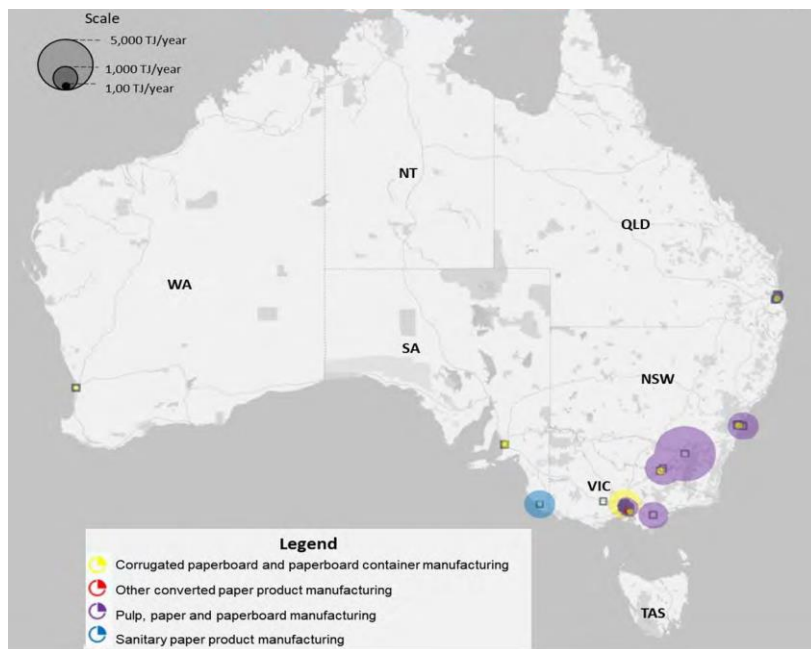

Figure 14. Location of pulp and paper manufacturing industries [2]

The pulp and paper industry produces a wide range of products, including various types of pulp, photocopier papers, packaging papers, newsprint, and tissue. In 2018-2019, 4 million cubic metres of wood logs were used in domestic pulp and paper, and industry sales were more than 10.5 billion AUD,

which accounts for 40% of total sales in the wood and wood-based products sector [24]. According to literature and the recent AES report, it can be estimated that pulp and paper industry demand is around 21.2 PJ/year in Australia [2]. The two distinct processes form the basis of papermaking: pulping (converting wood to an intermediate pulp product for shipment) and paper making (producing thin sheets). Although the process is sometimes integrated for large factories, non-integrated paper factories in Australia are more numerous, so they are treated as two separate processes.

Chemical pulping (dominated by the kraft process) uses the highest energy in the papermaking supply chain, hence its inclusion here; however, it also produces a large amount of by-product (black liquor) that is used as an energy source. In contrast, mechanical pulping – used for newsprint and low-cost products – mostly uses electrical energy and provides low-quality fibres. Semi-chemical processing is a further pulping process which applies chemicals to mechanical pulping, reducing thermal energy requirements compared to both processes, but it introduces complexity in environmental management due to the absence of chemical recovery in waste streams [40]. Australia has three large mills that produce pulp from wood chip, including Maryvale (VIC), Boyer (TAS) and Tumut (NSW), which are all located in regional areas [2]. Note, Boyer is a newsprint mill which uses mechanical pulping process, which is substantially different from chemical processes.

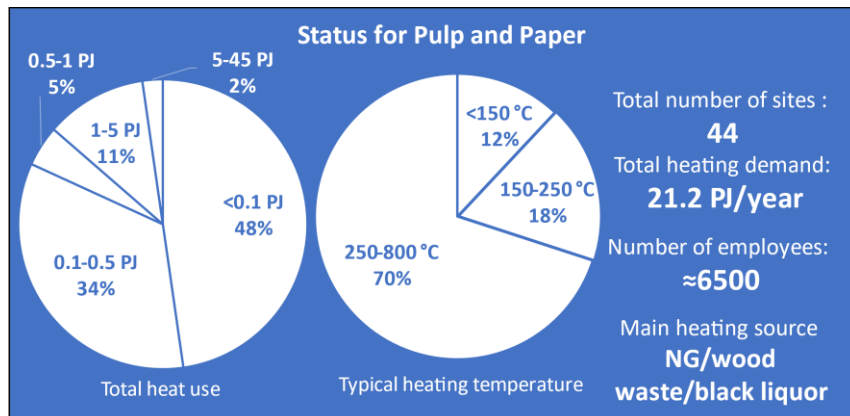

Figure 15. Status for pulp and paper [2, 6], ANZSIC Subdivision 15, under division C (manufacturing), groups 151 and 152

### 2.3.3.2 Typical process flow diagram and heating demand in kraft chemical pulping (Maryvale and Tumut)

This report focuses on kraft pulping, which is most common in the Australian pulp industry due to the high-quality pulp produced [7]. Figure 16 provides a flow diagram of the pulping process [2, 7, 40-44]. The most important steps are as follows:

- Debarking (electricity)
- Pulp digestion (65-175 °C)
- Pulp washing (60-70 °C)
- Pulp bleaching (30-90 °C)
- Evaporation (100-1100 °C)
- Pulp drying (40-55 °C)
- Lime kiln (340-1200 °C)

It should be mentioned that pulp bleaching is used if a white product is desired (Maryvale, not Tumut). The bleached pulp can be forwarded to the pulp drying process for transport to a paper mill, or retained as a wet slurry for paper making in the case of an integrated plant.



## Electrification & Renewables to Displace Fossil Fuel Process Heating

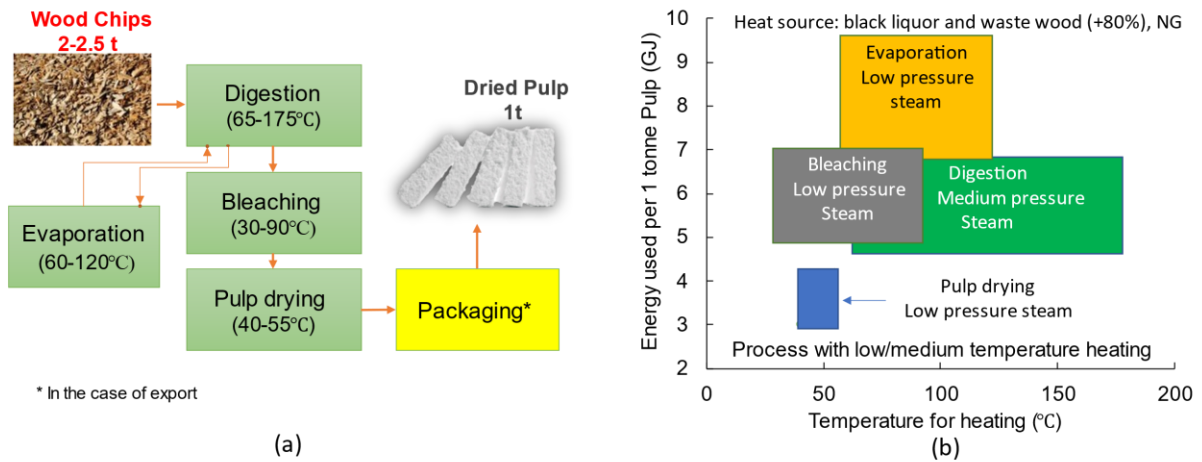

Figure 17. Kraft pulping overview, (a) simplified block flow diagram showing key heating consumers and their relative temperature/energy intensity, (b) for medium temperature heating.

### 2.3.3.4 Process flow diagram for papermaking

Figure 18 provides a flow diagram of the papermaking process [40, 42, 48-52]. The papermaking could be in an integrated site (such as Maryvale and Tumut) or separated (essentially all tissue/toilet paper manufacturers, which are numerous). There are many more paper/tissue factories than pulp factories in Australia. The most important steps are as follows:

- Stock preparation (40-100 °C)
- Forming paper (no heating)
- Pressing paper (40-50 °C)
- Drying paper (70-90 °C)
- Finishing (no heating)

The stock preparation stage is mostly a mechanical process [51] to make pulp from solid bales into a slurry in the correct proportions, which varies significantly with the intended final product. However, it only uses 8-16% of heating energy for some processes such as dispersion [42, 49]. The papermaking from pulp needs almost 4.5-6 GJ/t of dried paper, largely for drying [41, 42, 45].

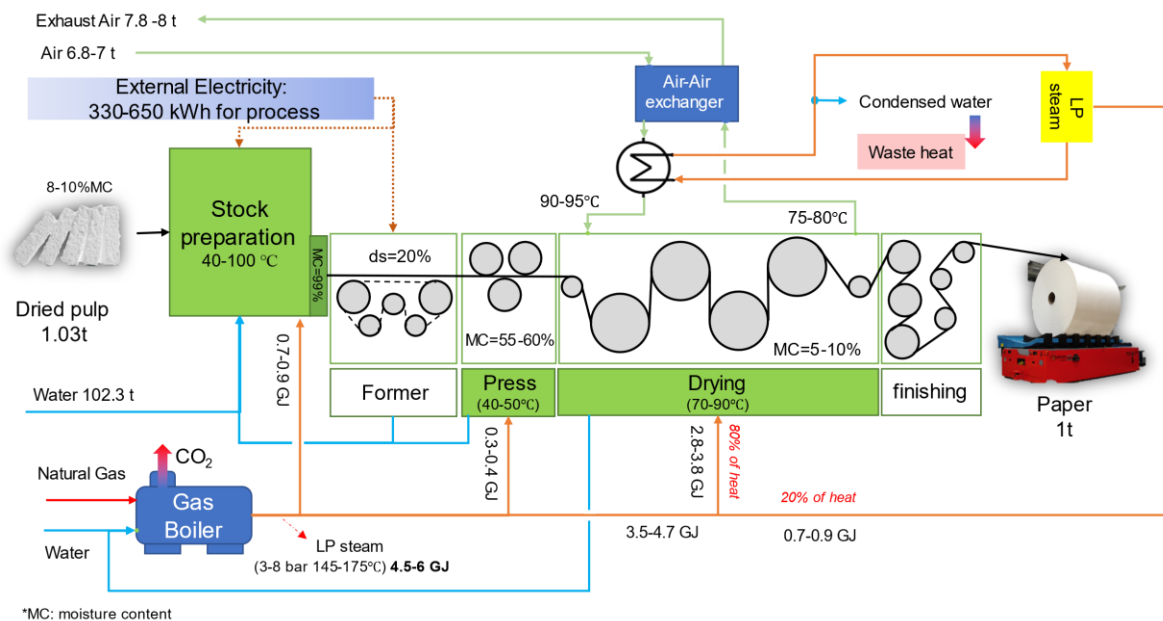

Figure 18. General process diagram for paper making.

2.3.3.5 Opportunities in papermaking

Tissue has been somewhat protected from international competition due to its low bulk density, making it relatively expensive to transport compared to most consumer products. Figure 19 provides a simplified overview of the paper processing in relation to energy and temperature demand. The factories mostly use natural gas in a regular boiler. In general, papermaking is more uniform in terms of process compared with pulp production (comparing kraft chemical pulping with mechanical pulping). This is interesting, since the improvement in the process or application of renewables could be applicable in a larger number of papermaking sites.

This opportunity for decarbonisation and saving energy in papermaking is possible by making the process more efficient and retrofitting the current mills with the best available technologies, with low to medium costs and with a short payback period. According to IEA, it is possible to reduce a typical papermill's primary energy by heat recovery from steam and waste heats by 1.07 GJ per tonne of paper [53]. Kong, Hasanbeigi [54] discussed emerging technologies divided into pre-treatment, pulping, and papermaking to reduce the energy consumption. There are more than 30 suggestions, including microwave pre-treatment for chemical pulping, membrane concentration of black liquor (rather than evaporation), and microwave paper drying. Optimising the ventilation in paper machines could reduce the steam by 0.75 GJ/t [43].

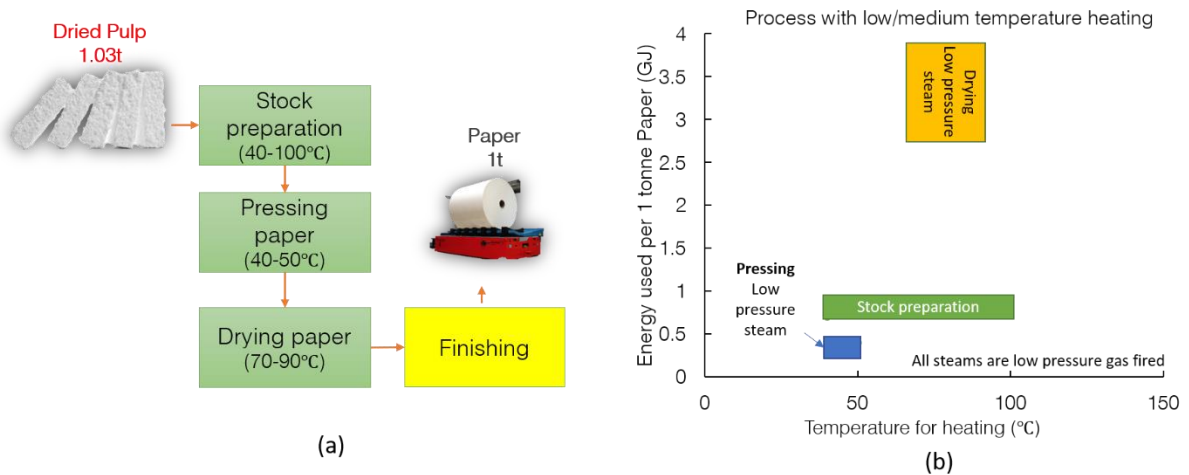

Figure 19. Papermaking overview, (a) simplified block flow diagram showing key heating consumers and their relative temperature/energy intensity, (b) for medium temperature heating.

2.3.4 Food product processing and beverage sector

2.3.4.1 Background

The food and beverage industry is a crucial sector in Australia's economy [55]. According to the Australian Food and Grocery Council, the food and grocery manufacturing sector's total turnover was 127.1 billion AUD in 2018-2019 [23]. Dairy and meat processing were the key contributing industries. Although beverage and tobacco products are categorised separately in ANZSIC, the beverage section is included and discussed in the AES reports. Recently, the Australian Renewable Energy Agency provided a mapping of food and beverage sector sites based on the National Pollutant Inventory (NPI) emission results (Figure 20) [2, 6]. The most energy-consuming industries are sugar manufacturing, meat processing, and dairy products manufacturing. Sugar mills provide almost all their thermal requirements using biomass (sugarcane bagasse) combustion, with some exporting electricity [56].

## Electrification & Renewables to Displace Fossil Fuel Process Heating

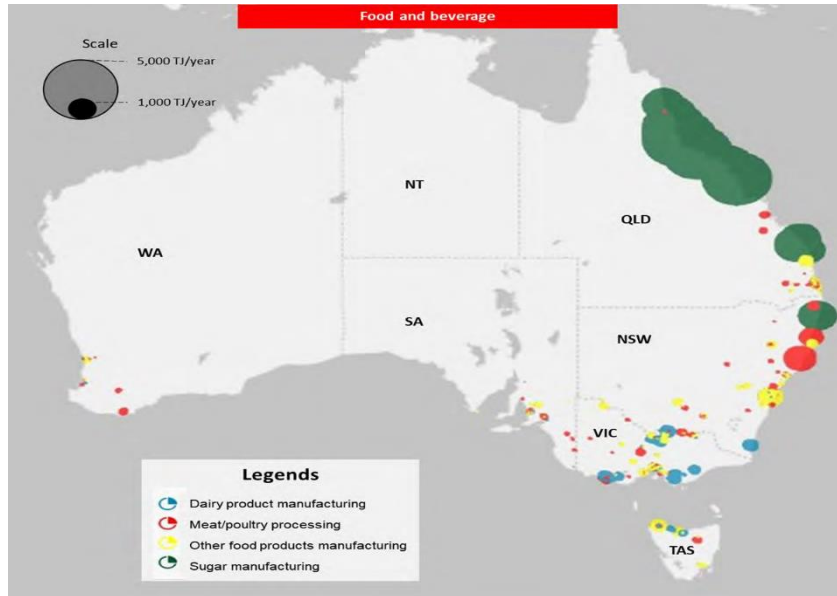

Figure 20. Location of food and beverage sites and their volume of heat use [2]

Figure 21 provides a general status overview of the food product and beverage manufacturing sector. There are numerous manufacturing sites for this sub-sector. The employment numbers were extracted from the 2018-2019 NPI employee report.

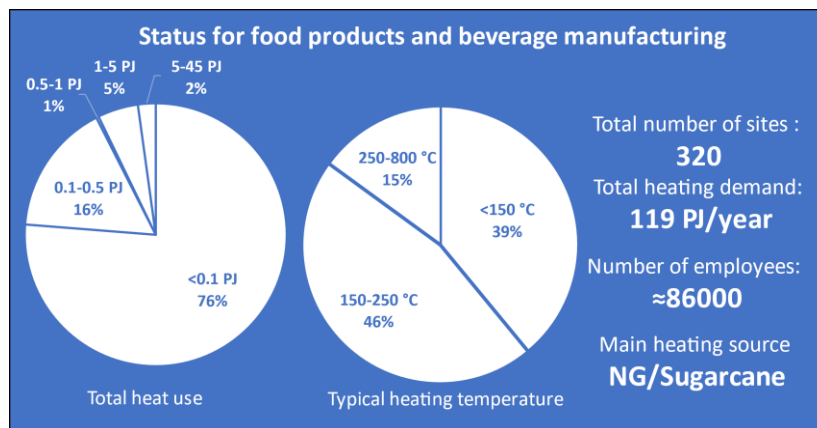

Figure 21. Status for food products and beverage manufacturing [2, 6], ANZSIC Subdivision 11 and 12, under division C (manufacturing), groups 111-119 and 121

The total number of reported sites in the NPI is 1,542 across all food and beverage producers. To this end, some small-scale food processing sites were not included in the NPI data. However, sufficient information is available to give a general comparative view of market and energy status for each sector. Most food manufacturing sites (76%) use less than 0.1 PJ annual heating energy, while 85% of heating occurs at a temperature less than 250 °C, which shows great potential for renewable heating or electrification.

### 2.3.4.2 Process flow diagram and heating demand in dairy processing

Dairy is the fourth largest rural Australian industry, producing milk-based products [4]. According to Dairy Australia [57], retail demand for dairy products such as butter, cheese, yoghurts and milk increased by 4.6-8.7% in 2020. The total milk production in 2019-2020 was 8,784 million litres with a value of 4.8 billion AUD [57]. 29% of Australian dairy products are exported - mostly to China, Japan, and Singapore. For the first time since 2014, milk production in exporting regions increased for more

than 120 days in a row [57]. Milk production mostly includes milk collection, heating, cooling, transportation, and packaging.

Figure 22 represents a simplified process diagram of a milk processing factory focusing on milk powder production [58-64]. Milk powder processing is amongst the highest thermal energy consuming processes in the dairy industry. The most important steps are as follows:

- Pasteurisation/treatment (80-120 °C)
- Pre-evaporation (65-75 °C)
- Spray drying and fluidised bed dryers (35-200 °C)
- Cleaning in place (60-65 °C)
- Other value-added product processing (cheese, butter, yoghurt, milk) (70-110 °C)

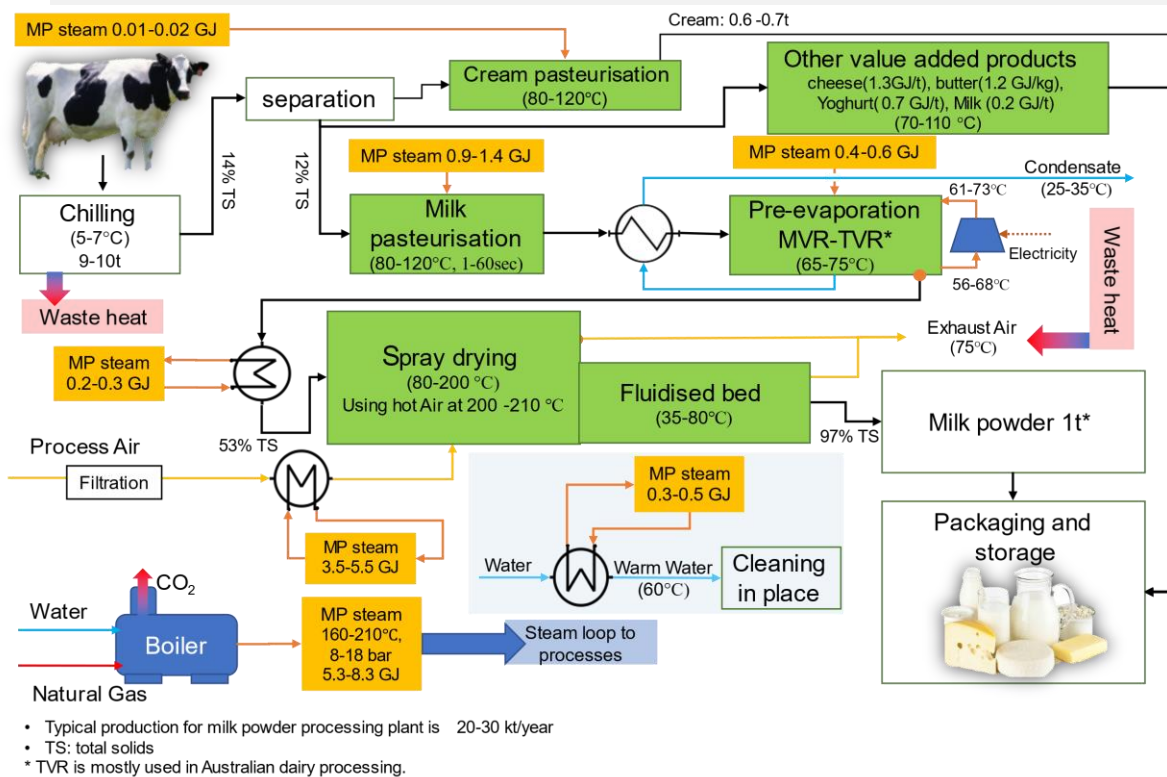

Figure 22. General process diagram for dairy processing.

Some of the unit operations are common for other value-added products such as pasteurisation or spray drying, which is commonly used in whey and cheese powder processing [65]. However, some specific processes are unique for each product e.g., scalding for cheese, ripening for butter or fermentation for yoghurt [66].

It is estimated that 0.53-1.5 GJ (1.02 GJ on average) per kL of raw milk is needed for producing various dairy products [65], which causes 141 kg of Carbon Dioxide Equivalent emissions. The Dairy Australia survey results estimated that 84% of dairy processing energy is used for heating [65].

The typical thermal energy use in a modern factory is 5.3 GJ to produce 1 tonne of milk powder from 9-10 tonne of raw milk [61]. However, in Australia, 8.3 GJ thermal energy is needed (on average) to

produce the same amount [64]. Other important dairy processes in Australia, such as cheese (1.3 GJ/t), butter (1.2 GJ/t), yoghurt (0.7 GJ/t) or milk (0.2 GJ/t) demand lower thermal energy [64].

### 2.3.4.3 Opportunities in dairy processing

Figure 23 provides a simplified overview of the dairy processing in relation to energy and temperature demand. Natural gas is by far the most used source of heating. However, some facilities use LPG or other fossil fuels [65]. In 2019, Dairy Australia released possible opportunities in dairy processing to reduce heating demand [65]. The improvements include using MVR in the milk evaporation process, using reverse osmosis for concentration instead of conventional evaporation, improving efficiency, reducing heat loss and heat recovery from spray dryers, boiler efficiency improvement techniques, and optimised steam delivery methods. The latter includes rectification of steam leaks, using boiler condensate return heat, maintenance of steam traps, and pipe insulation.

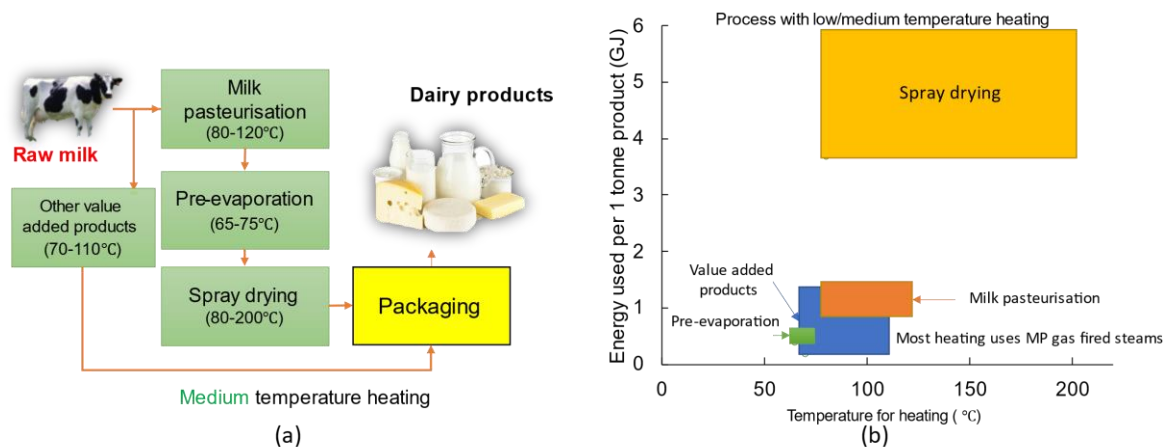

Figure 23. Dairy processing overview, (a) simplified block flow diagram showing key heating consumers and their relative temperature/energy intensity, (b) for medium temperature heating.

### 2.3.4.4 Process flow diagram and heating demand in meat processing

Australia is the world's second-largest meat exporter with up to 68% of produced meat and meat products being exported [67]. Hence, red meat processing is the largest food manufacturing sub-sector in Australia, worth 17.6 billion AUD [67, 68]. More than 57% of meat processing sites across Australia produce beef, which consumes a considerable amount of energy for electricity and heating [67]. Depending on meat processing facilities, it can produce a wide range of edible (e.g., meat, blood meal, liver, gelatine, sausage tripe) and non-edible products (e.g., fertiliser, pharmaceuticals, hide, bone), which slightly above 80% of livestock products [68]. The remainder is organic residues like dissolved nutrients and waste activated sludges that will also be used in composting. Figure 24 provides a typical meat processing plant that includes slaughtering and separation of edible products and converting non-edible by-products to useable products [69-74]. The most important steps are as follows:

- Slaughter and evisceration (43-82 °C)
- Hide Processing (43-82 °C)
- Paunch processing and offal washing (43-82 °C)
- Blood processing (110-130 °C)
- Rendering (115-145 °C)



Steam is the main source of heat in the meat processing plant. Steam is either used directly in rendering and blood processing or indirectly for providing hot (82 °C) and warm (43 °C) water for cleaning and sterilisation. The waste heat from exhausted steam in the rendering process is recovered for generating the hot water, and it can supply almost 60-70% of total energy needs for plant hot/warm water [69]. The operation in meat processing mentioned in the bullet points above is mostly batch, including a defined daily schedule for boiler operation, hot/warm water production, the slaughter floor, boning room, cleaning, and rendering.

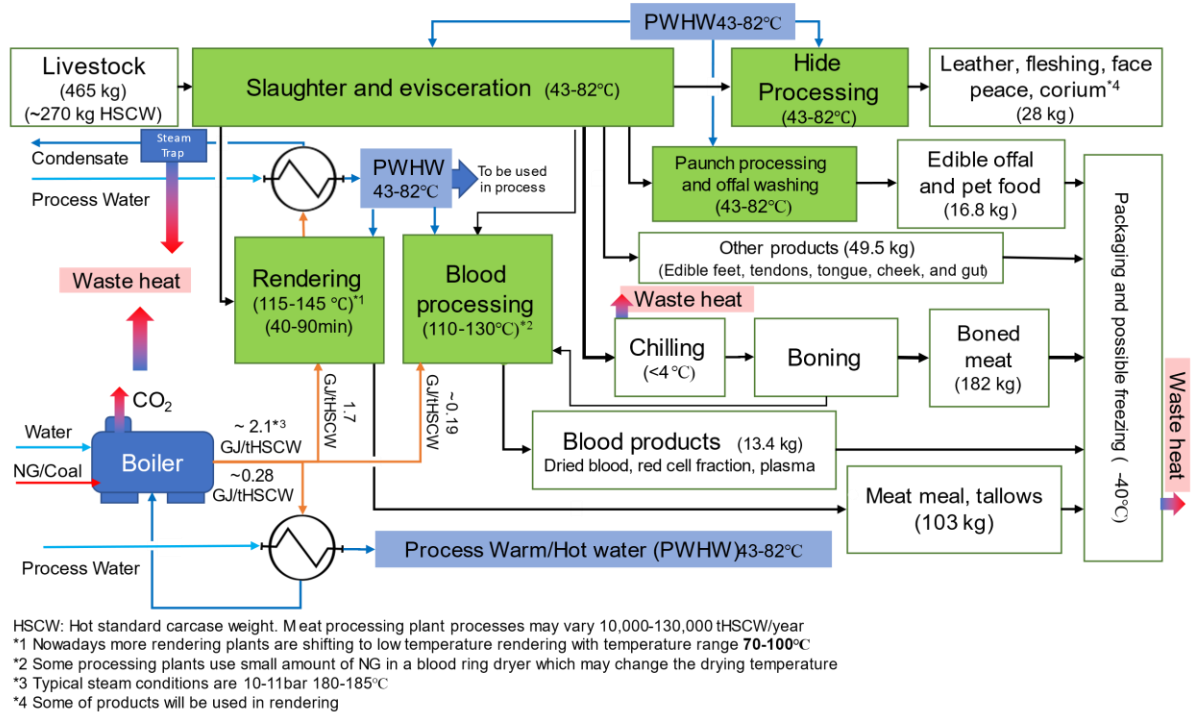

Figure 24. General process diagram for red meat processing

According to the recent Australian Meat Processor Corporation (AMPC) report (March 2021), each typical red meat plant uses 3.3 GJ per tonne of Hot Standard Carcase Weight (HSCW) on average for both electricity and heating [75]. However, the exact amount of energy consumption depends on the type of red meat being used and the specific processes in each meat processing plant. Without rendering, electricity and heating usage are similar. However, adding a rendering unit increases the total energy demand and increases the thermal energy share to 60-80% of total energy used due the additional required energy for rendering and washing [76]. More than 65% of electric usage demands for refrigeration to around -40 °C.

#### 2.3.4.5 Opportunities in meat processing

In meat processing, medium pressure steam, hot water (82 °C), and warm water (43 °C) are the three primary heating energy sources. Almost 7.9 kL/t HSCW water is required for the process in which 30-40% of water is turned into warm/hot water [69, 75]. The boilers mostly use natural gas (47%) and coal (28%) [71]. Black coal is used primarily in northern Australia, while natural gas is more common in southern states [70]. Figure 25 provides a simplified overview of the meat processing in relation to energy and temperature demand. Energy efficiency improvement has considerably assisted the Australian meat industry in reducing energy usage. For example, a 27% reduction in energy usage has been reported, according to the AMPC surveys from 2008 to 2014 [71].

Further opportunities for reduction in energy or fossil fuel consumption include refrigeration heat recovery (due to rejection of large amounts of waste heat from the chiller condensers, which could

provide supplementary heat for fossil fuels in the boiler), improving refrigeration efficiency, improving boiler and other thermal efficiency improvements such as rendering waste heat recovery or applying renewable and alternative fuels such as biomass boilers [72]. Reducing the current sterilisation temperature from 80-82 °C to 60 °C could reduce the total energy by 11% [73]. According to AMPC, meat processing emissions in 2013-2014 were 432 kg CO<sub>2</sub>e/tHSCW [71]. This can produce up to 1.3 MtCO<sub>2</sub> per year (3.1 Mt production in 2018), which should be considerably reduced to 0.5 MtCO<sub>2</sub>/year by 2030 to meet the Paris agreement for carbon neutrality by 2050 [72]. It should be mentioned according to most recent report by AMPC, red meat processor throughout for 2020 was around 3.45 Mt HSCW for the year, across 130 plants with average emission of 397 kg CO<sub>2</sub>e/tHSCW which shows 8.1% reduction in emissions [75]. Improving energy efficiency and applying renewable energy is the focus of AMPC for further policy and research [67].

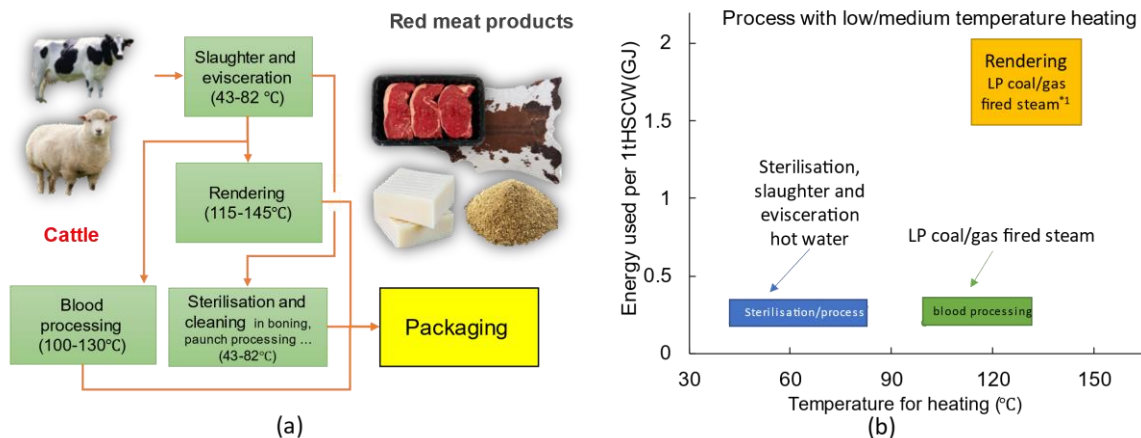

1\* The recovered heat in rendering will be used for additional hot water supplying

Figure 25. Meat processing overview, (a) simplified block flow diagram showing key heating consumers and their relative temperature/energy intensity, (b) for medium temperature heating.

#### 2.3.4.6 Process flow diagram and heating demand in beer production

Beer is the most popular beverage in Australia, and Australians consume 5 million litres of beer every day [77]. According to the Brewers Association of Australia [78], total beer consumption in Australia in 2017-2018 financial year was 1,690 million litres. Australian breweries provided up to 84% of domestic consumption. Only 16% of the consumption is imported (275 million litres), and exports are relatively small compared to other food and beverage producers (22 million litres). Australia has up to 740 craft breweries [79]. However, craft beer production was only 58 million litres in 2017-2018. More than 90% of Australian beer is produced in the major commercial breweries (1,342 million litres). The major producers are Lion (in Camperdown, Lidcombe, Milton, Thebarton, Fremantle, Geelong, and Launceston), AB InBev (Abbotsford, Yatala, Hobart, Sydney, Adelaide), and Coopers Brewery Ltd. (Regency Park in Adelaide). Figure 26 provides a general process diagram for beer production [80-87]. Beer production includes the conversion of grain starch into sugars and finally conversion to alcohol using mashing, boiling with hops and fermentation with yeast. The most important steps are as follows:

- Grain mashing and lautering (45-75 °C)
- Hop/wort boiling in the kettle (95-100 °C)
- Whirlpool tank (40-80 °C)
- Packaging and pasteurisation (60-70 °C)
- Cleaning in place and other heating demand (70-90 °C)
- Other cooling stages (fermentation, filtration, flotation)

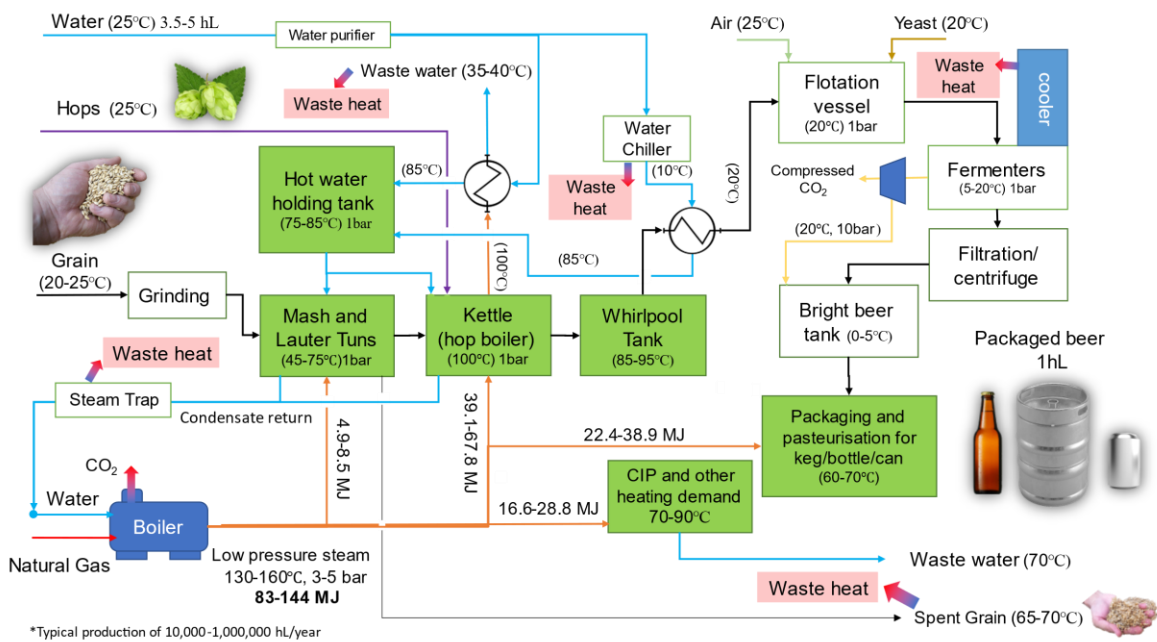

Figure 26. General process diagram for beer processing

According to the literature, 60-80% of the total energy consumption is thermal energy, impacting electrification/decarbonisation [77, 80, 84, 88]. The thermal energy usage for heating is significantly dependent on the annual beer production rate. While various studies reported high variability in energy consumption for thermal energy (e.g. 43MJ/hL [89], 170 MJ/hL [84], 226 MJ/hL [90] ), it could be estimated that the total thermal energy consumption is typically in the range 83-144 MJ/hL for breweries which annually produce 10,000-1,000,000 hectolitres (1 hectolitre=100 litres) of beer. Low-pressure steam is the main source of heating.

Approximately 45-60% of steam is used in the mash tun and hop boiler [88, 90-92]. However, around 80% of allocated steam is used in the hop boiler rather than the mash tun [88]. Pasteurisation and packaging consume 20-33% of total heat [80, 90, 92, 93]. The bottle/can pasteurisation uses around twice the heating of keg processing. Beer production is a batch process in which equipment requires cleaning[81]. The rest of the thermal energy is mostly used in cleaning-in-place (CIP) operations. This unit mostly uses hot cleaning solutions (e.g., 2% caustic solution) for cleaning proteins, oils, and other organic materials from the surface of vessels, piping, tubing, and so on [80].

2.3.4.7 Opportunities in beer production

The high degree of process uniformity across Australian breweries makes recommendations highly applicable across the sector. Although the energy usage is relatively modest, implementation of fossil fuels replacement/electrification are very broad. In Australia, the primary source of thermal energy for breweries is natural gas [80]. Large plants have several gas-fired boilers with steam production operating at 9 bar pressure. However, due to pressure drop, the final pressure will be 3.5-5 bar [80]. Figure 27 provides a simplified overview of the beer production in relation to energy and temperature demand. Although a significant amount of energy is recovered by condensing steam produced in the kettle, there are other potentials for saving energy.

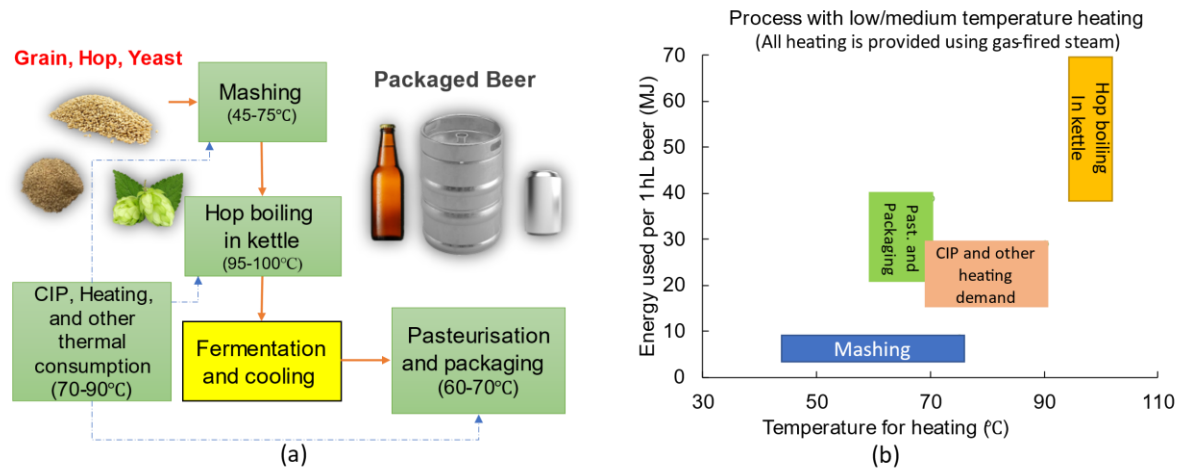

Figure 27. Brewery overview, (a) simplified block flow diagram showing key heating consumers and their relative temperature/energy intensity, (b) for medium temperature heating.

Muster-Slawitsch et al. [89] analysed the heat recovery potential of a modern brewery and categorised the recovered heat into three different levels of potential. The high potential energy sources are the hot spent grain, wastewater for keg washing and CIP, vapour losses at boiling start-ups, and waste heat in the boiler flue gas. Anaerobic digestion of plant wastewater can generate biogas, reducing boiler natural gas consumption. The European Commission [94] provided some solutions for reducing the total energy usage, including preheating the wort before going in the kettle (up to 92 °C, instead of the traditional 70 °C), which reduces the length of boiling and total energy used. The pasteuriser may be operated by solar thermal energy covered by waste heat energy (such as spent grains or refrigerators) in the plant. However, it may need a substantial retrofit to achieve this outcome [94].

2.3.5 Heating in hospitals

2.3.5.1 Background

Hospitals provide an essential service to our society. Australian healthcare energy use per capita is among the highest in the world [95]. Figure 28 shows hospital sites across Australian statistical area level 2 [96]. Most hospital sites are near to population centres and major cities.

## Electrification & Renewables to Displace Fossil Fuel Process Heating

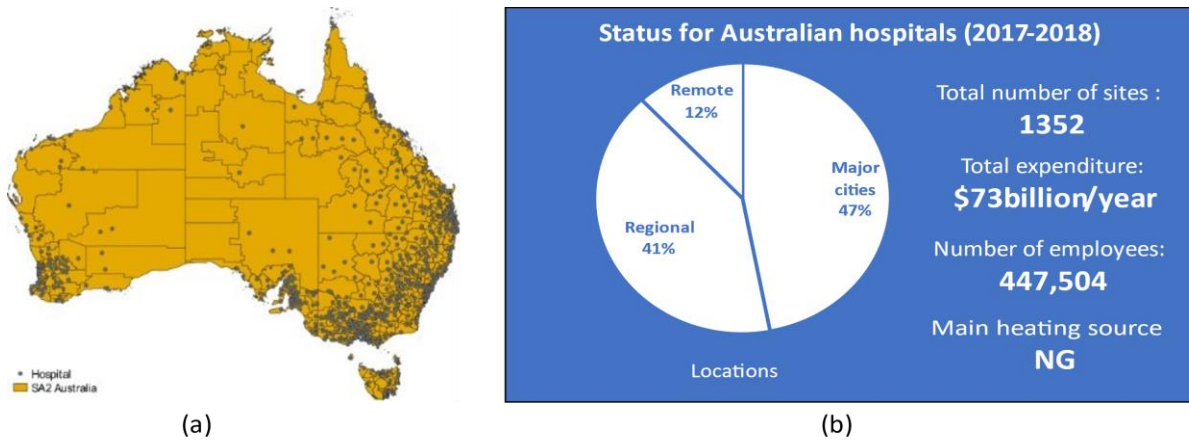

Figure 28. Hospitals overview (a) sites on the map of Australia (SA2: statistical areas level 2)[96], (b) other important information

There are over 1,300 hospitals in Australia, with 47% hospitals in major cities, 41% in regional areas and 12% in remote areas. The total expenditure of both public and private hospitals was about 73 billion AUD in the financial year 2017-2018. The sector employs over 447,000 people and most of its heating is generated from natural gas. Table 1 provides more summary statistics for Australian public and private hospitals.

The number of public hospitals is similar to the number of private hospitals. Public hospitals served about 60% of all separations and two-thirds of all patient days. Separation is the process by which an episode of care for an admitted patient ceases [97]; the number of patient days is the total number of days for all patients who were admitted for an episode of care and who separated during a specified reference period[98].

Table 1. Australian hospital summary statistics (2017-2018) [99-101]

Types:	Public hospitals (AIHW)	Private hospitals (ABS)	All hospitals (ANZSIC 8401 and 8402)
<b>Number</b>	694	657 (2016-17)	1352
<b>Bed/chairs</b>	62,224	34,339 (2016-17)	96,563
<b>Separations</b>	6,917,739	4,569,128	11,486,867
<b>Patient days</b>	20,257,957	9,980,372	30,238,329
<b>FTE employment</b>	378,205	69,299 (2016-17)	447,504
<b>Total Expenditure (AUD)</b>	58 billion	16 billion (approx. 1% for fuel and power)	73 billion
<b>Geographic locations</b>	26% sites in major cities 58% sites in regional 16% in remote 68% beds in major cities 29% beds in regional areas 3% beds in remote areas	81% of sites in major cities 19% of sites in regional areas	47% sites in major cities 41% sites in regional areas 12% in remote areas

Approximately 1% of Australian private hospitals' expenditure is spent in fuel and power, which is equivalent to 63 million AUD for the private sector. However, no fuel expenditure statistics were found for public hospitals. About a quarter of public hospitals are in major cities and 81% of private hospitals are in major cities.

2.3.5.2 Process description

In terms of fossil fuel for hospital heating processes, common fuel types include natural gas, diesel and coal. Figure 29 shows the heating system process flow diagrams at a major Brisbane hospital. There are two different types of boilers, one type for water heating and another type for steam heating. Water coming to those boilers is treated to reduce hardness levels, dust and air. Different methods can be used to treat incoming water, such as chemical, physical or electronic methods. Water treatment facilities, pumps and associated accessories are not included as they are not relevant to the fossil-fuelled heating process.

Natural gas is a common energy source for water and gas heating in Australia. Typical gas boiler efficiency ranges from 85% to 95%, depending on the selection of boiler technology [102, 103]. For example, condensing boilers use waste heat in the flue gases to preheat water entering boilers. Those condensing boilers have a typical thermal efficiency of 92% to 95% [103].

On the top section of Figure 29, the hot water is supplied at 75 °C. On the hospital side, the hot water is used to heat potable water and softened water. Depending on the needs and design, hot water outputs may be used for other purposes, for example hot water supply at taps, commercial and hospital grade dish washing in kitchens. The bottom section of Figure 29 shows the separate steam heating system for the same major Brisbane hospital. The steam is for sterilisation and air conditioning humidifying purposes. However, the humidifying function is rarely used in the Brisbane major hospital due to the humid climate. Depending on the needs and design, steam outputs may be used for other purposes.

Other applications of gas-fuelled heating at hospitals can include gas cooking in hospital kitchens, or retail restaurants. This cooking-related gas heating may be separate from the main hospital boiler hot water supply.

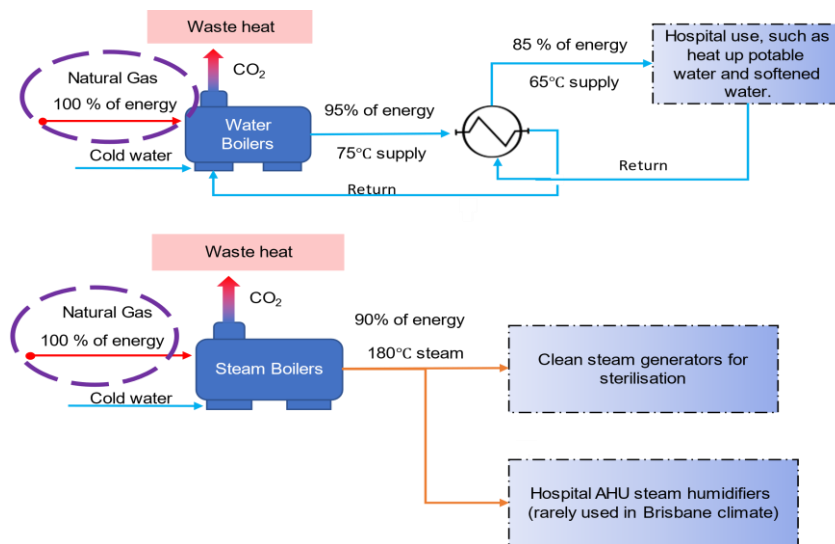

Figure 29. A major Brisbane hospital hot water system process flow diagram

2.3.5.3 Opportunities in hospitals

A few opportunities exist for heating electrification within a hospital context, such as fossil-fuelled water boilers and fossil-fuelled steam boilers at energy plants. In addition, there are often other gas heating sources in hospital kitchens or amenity areas for wards or commercial purposes, such as for cooking needs and water heating for dish washing or tap water.

## Electrification & Renewables to Displace Fossil Fuel Process Heating

For the major Brisbane hospital under consideration, 897 thousand cubic metres of natural gas was used in 2019 for the water boilers and steam boilers, which is equivalent to 34.1 TJ [104]. 64% of the gas was consumed by water boilers and the remaining 36% was used by steam boilers. For water and steam heating, the gas consumption is 0.33GJ per patient day for the major Brisbane hospital. Therefore, it is about 212 MJ per patient day for water heating, and 121MJ per patient day for steam heating. Figure 30 shows the energy intensity per patient day, as well as the temperature ranges.

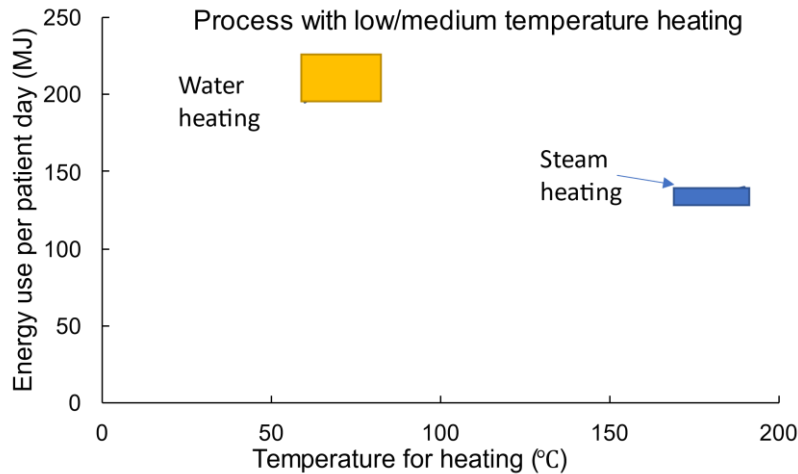

Figure 30. Relative temperature and energy intensity for hospitals

### 2.3.6 Heating in residential aged care facilities

#### 2.3.6.1 Background

There are over 800 residential aged care (RAC) service providers across Australia. The greatest number of those services are on the eastern seaboard and around the southwest corner of Western Australia. Figure 31 shows aged care services across Australia's states and territories.

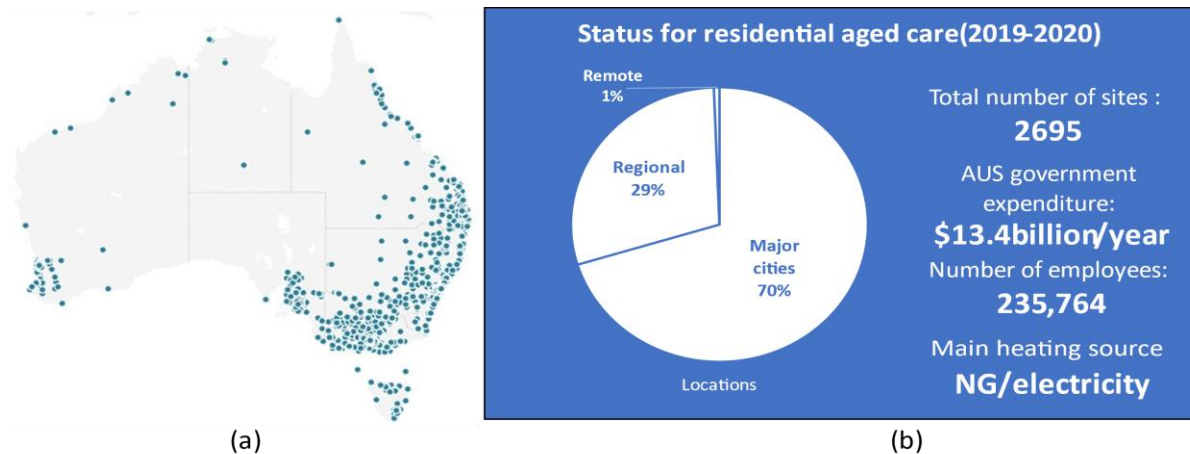

Figure 31. Residential aged care overview (a) sites on the map of Australia[105], (b) other important information

There are over 2695 service sites, with 70% in major cities, 29% in regional areas and 1% in remote areas. More than 235,000 people work in the RAC sector. Most heating sources are natural gas and electricity. The natural gas heating area is of interest to the heating electrification project.

Table 2 provides more summary statistics for RAC in Australia. There are over 800 RAC providers and more than 183,000 residents living in RAC communities. 70% of residents are in major cities, 29% in

regional areas and 1% in remote areas. The Australian Government expenditure for the sector was 13.4 billion in the financial year 2019/2020.

Table 2. RAC summary statistics (2019-2020) [105-108]

Type:	Residential aged care (ANZSIC Class 8601)
No. of RAC providers	845
Residents	183,989
Direct care employees (head count)	153,854 (2016)
Direct care employees (FTE)	97,920 (2016)
All PAYG employees	235,764 (2016)
Geographic locations	70% residents in major cities 29% in regional areas 1% in remote areas

2.3.6.2 Process description

RAC facilities provide healthcare services to residents, similar to parts of hospitals’ services. However, the water heating process at RAC facilities is more similar to residential communities, small hotels or office buildings. A typical aged care water heating process is illustrated in Figure 32.

Natural gas is the typical fossil fuel for RAC facilities’ water heating needs, which is the second-largest energy use based on an auditing of 15 NSW RAC facilities [109]. There are electrical storage water heaters installed at Australian RAC facilities near to points of water use [109, 110], however sector-wide statistics are not known. Hot water is supplied at no more than 45 °C out of residents’ taps and no more than 50 °C for community services, such as kitchens for sanitary purposes [111].

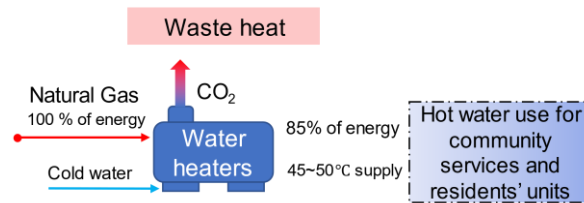

Figure 32. A typical aged care hot water system process flow diagram

2.3.6.3 Opportunity in residential aged care

There are a few opportunities for electrifying heating at RAC facilities, including hot water supply to residents and community services, and kitchen cooking needs. Other applications of gas fuelled heating at RAC facilities can include commercial cooking in kitchens, such as for gas ovens and cooktops. In terms of providing hot water supply to residents and community services, the upper band energy intensity for 1 resident is estimated as 7.5 MJ/day<sup>4</sup>. The lower band energy intensity for one resident is estimated as 5.3 MJ/day<sup>5</sup>. A visual diagram of the energy intensity is presented in Figure 33. The 50 L is the specified hot water supply in the Australian National Construction Code Volume One [112].

Hot water is considered to be supplied at 50 °C in the above calculation. However, the actual temperature in water heaters or boilers may be between 60 °C to 80 °C in order to eliminate legionella. 14.5 °C is the lowest yearly average cold water temperature in Australian climate zone 4 in

<sup>4</sup> 50L at 50 °C delivery temperature and 14.5 °C supply temp  
<sup>5</sup> 50L at 50 °C delivery temperature and 24.8 °C supply temp



[113]. 24.8 °C is the highest yearly average cold water temperature in Australian climate zone 1 in [113]. Note that 4.2 kJ/°C of energy is needed to increase 1kg (≈1L) water temperature by 1 °C.

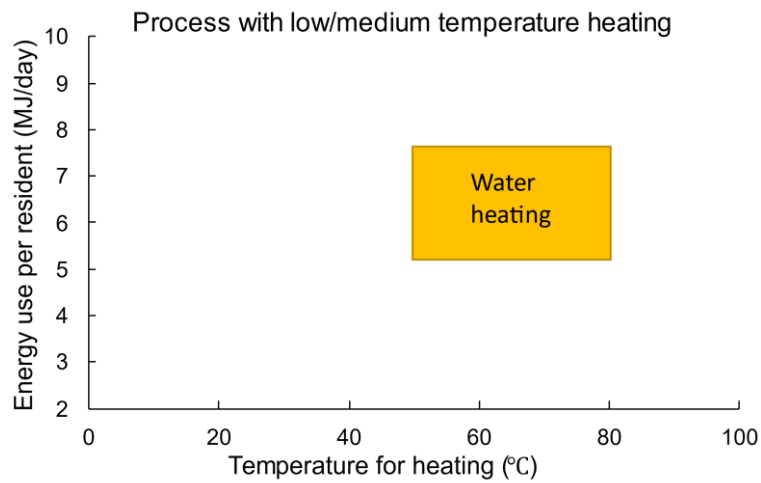

Figure 33. Relative temperature and energy intensity for residential aged care facilities

The Australian RAC residents’ water heating energy needs in a year is estimated as 0.45 PJ/year. 183,989 residents were in Australian RACs by the end of June 2020 (Table 2). The inlet cold water temperature 18 °C is the population weighted average temperature based on Table A6 in AS/NZS 4234 [113]. 365 days in a year are considered in the above calculation.

### 2.3.7 Heating in hotels

#### 2.3.7.1 Background

In this section, hotels are defined as accommodation facilities (excluding residential homes in the sharing economy, e.g. Airbnb). Figure 34 presents an overview status for hotels in Australia. There are over 4,400 hotels in Australia, generating 10.43 billion AUD for accommodation services. More than 105,000 people work in the sector to provide accommodation-related services. The ABS data [114] includes statistics from hotels, motels and serviced apartments with 15 or more rooms. Natural gas is a common heating energy source for hotels in Australia.

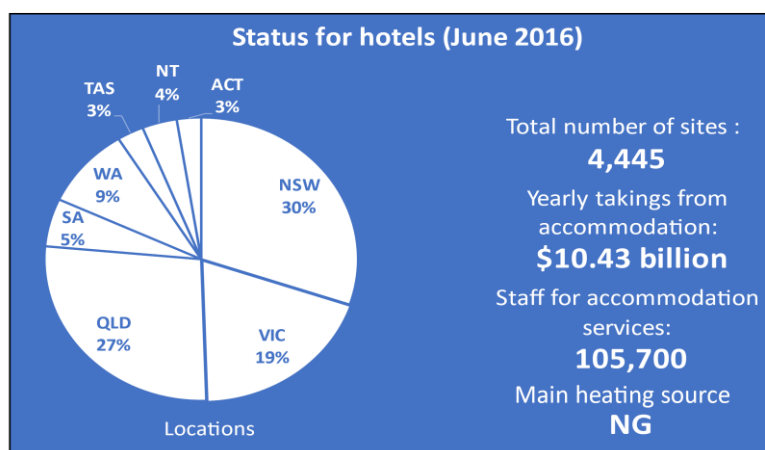

Figure 34. Status for hotels in Australia as at June 2016 [114, 115]

As summarised in Table 3, Australian hotels had 249,131 rooms and serviced more than 102 million guest nights in the financial year of 2015 to 2016. New South Wales, Queensland and Victoria have more than three quarters of all hotel rooms in Australia.

## Electrification & Renewables to Displace Fossil Fuel Process Heating

Table 3. Hotel summary statistics as at June 2016 (collated from [114])

Type:	Hotels (ANZSIC 4400)
Rooms	249,131
Guests nights occupied	102,989,700
Geographic locations	30% rooms in NSW; 27% rooms in QLD; 19% rooms in VIC; 9% rooms in WA; 5% rooms in SA; 4% rooms in NT; 3% rooms in TAS; 3% rooms in ACT;

The broader hospitality industry employs 105,700 people for accommodation services, while 745,400 people are employed for food and beverage services. Reference [115] includes hospitality industry statistics for hotels, cafés and restaurants.

### 2.3.7.2 Process description

Depending on the needs and design, hotel heating systems can vary. Figure 35 is a typical hot water system for a hotel. Natural gas is a common energy source for a hotel water heating system. The hot water output can be used for room services, such as for bathtub, shower and tap hot water; hotel services, such as for kitchen and laundry services (not at a large scale); space heating, such as for heating in a central HVAC system; or for heating a swimming pool. For a small hotel, room and hotel services may be the focus of demand for centralised hot water, since space heating is typically provided by electric air conditioners. The swimming pool heating may not be needed as these smaller hotels often have no swimming pool or their pool is not heated.

The percentages of energy used for HVAC or swimming pools can vary significantly, mostly depending on the design of the swimming pools and HVAC, and the local climate conditions, including swimming pool sizes, outdoor or indoor pool, warm humid climate or cold dry climate, etc.

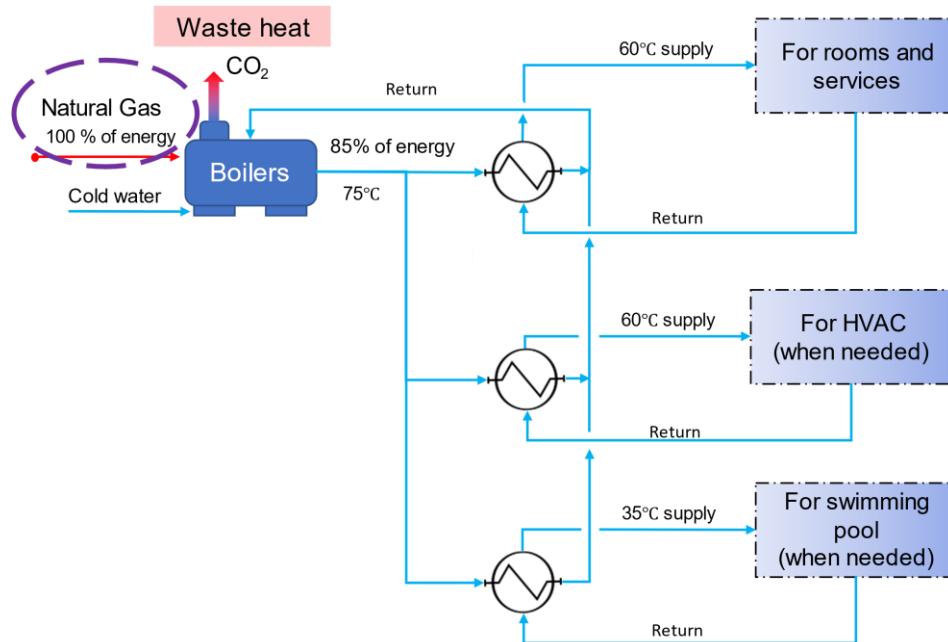

Figure 35. A typical hotel hot water system process flow diagram

### 2.3.7.3 Opportunity in hotels

For hotels, heating electrification opportunities exist for water heating for rooms and services, water heating for HVAC, water heating for swimming pools, and commercial kitchen cooking needs. In terms of providing hot water supply to hotel guests, the upper band energy intensity for 1 guest per day is

estimated as 11.9 MJ/day<sup>6</sup>. The lower band energy intensity for 1 guest per day is estimated as 8.9 MJ/day<sup>7</sup>. A visual diagram of the energy intensity is presented in Figure 36. This estimation is based on AS/NZS3500.4 [111] and NCC Volume One in [112]. A detailed description of the estimation basis has been included in Section 2.3.6.3.

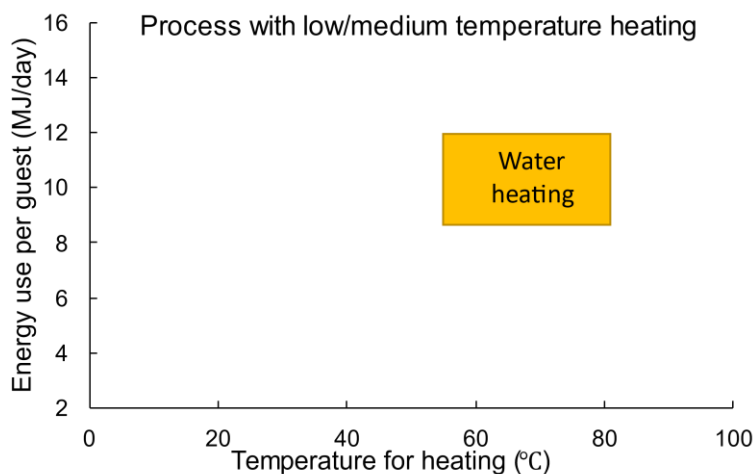

Figure 36. Relative temperature and energy intensity for Australian hotels

Guests' water heating energy needs in a year are estimated as 1.12 PJ/year. 102,989,700 guest nights were recorded for Australian hotels in the financial year to the end of June 2016 [114]. The inlet cold water temperature of 18 °C is the population-weighted average temperature based on Table A6 in AS/NZS 4234 [113].

## 2.4 Australian and Global Leaders: Best Practices

### 2.4.1 Australian Case Studies

Despite the reliance on natural gas in Australia, there are excellent examples of leaders in the shift away from fossil fuels. Exemplars of adopting high efficiency electrical technologies to replace fossil fuel combustion are present throughout the Australian private sector. The examples presented here represent current leaders in technology uptake, and are taken from previously collated case studies:

- Thomas Foods International [116]. In 2012, the Lobethal Abattoir in South Australia replaced gas-fired water heating (250kL daily to 75 °C from a combination of 11 °C mains water and 30 °C waste heat) with a two-stage ammonia heat pump for hot water sterilisation at cost of 800 thousand AUD [117].
- Nightingale Housing. Although a residential building, the Nightingale 2 Apartment building, completed in 2019, provides an example of efficient space heating and hot water supply to multi-storey buildings. Water heating is provided by a pair of 15 kW CO<sub>2</sub> heat pumps (COP = 4.2) to achieve an 8.2 star NatHERS rating.
- Yanakie Dairy Farm [118]. In contrast to the above examples of alternative heating technologies being used as substitutes for fossil fuel combustion, the Yanakie Dairy Farm substituted off-site evaporation processes with on-site reverse osmosis for water extraction. Key points from this study were a two year payback period, mostly owing to savings in product transport; and that the pilot system demonstrated through a lease agreement with the manufacturer, Tetra Pak Dairy & Beverage.

<sup>6</sup> 70L at 55 °C delivery temperature and 14.5 °C supply temp

<sup>7</sup> 70L at 50 °C delivery temperature and 24.8 °C supply temp

- De Bortoli Wines [119]. Having already won several awards for their approach to sustainability, are engaged a feasibility study for replacing natural gas boilers with ammonia heat pumps (to heat 12kL of water, daily, to 95 °C) for a capital cost of nearly 1 million AUD and an estimated 4.8 year payback period. This is planned in conjunction with an upgraded solar PV system and these will complement existing evacuated tube solar thermal water heating and existing solar PV [120]. The 14.5 million AUD capital cost for the solar thermal and initial solar PV upgrade was substantially offset with 4.8 million AUD of federal government funding.

The above examples are cases where heating processes – or non-thermal alternatives – have been implemented, however companies setting their own sustainability targets have their own roadmaps to transition to renewable fuels. It is also important to note that, in all cases, heat pumps are used to heat water to outlet temperatures below 100 °C and not for steam production from a liquid water supply.

- Alcoa [121]. In January 2021 Alcoa began a feasibility study to investigate integration of a mechanical vapour recompression (MVR) module into their alumina processing at their Wagerup (in Western Australia) refinery as a means of displacing fossil fuels in steam generation. This retrofit has initially been sized as a 3 MW MVR module, supplied by renewable energy sources. This is significantly subsidised by federal government funds, with 11.28 million AUD of the 28.21 million AUD (that is, 40% of the total cost) feasibility and commissioning process have been committed by the Australian Renewable Energy Agency (ARENA) through the Advancing Renewables Program.

### 2.4.2 International Case Studies

International uptake of alternatives to fossil fuel combustion for low temperature process heat has been a priority for numerous companies and governments world-wide. This is notably reflected in the International Energy Agency's 2025 net zero emissions milestone of no new sales of fossil fuel boilers by 2025 and heat pumps meeting 20% of global process heat demands by 2030 and 50% by 2045 [4]. Several examples of best practices by global leaders in the shift away from fossil-fuels are presented from manufacturers and previously collated case studies:

- Mars Inc. The US-based company Mars Inc. has a commitment to be 100% fossil-fuel-free by 2040. In approaching this target, the Mars factories in Sochaczew (Poland) [122] and Veghel (the Netherlands) [123] have both been upgraded. In the Polish case, co-located chocolate and pet-food factories use on-site waste water with biogas recovery, anaerobic digestion, reverse osmosis and a combined heat and power system to supply 185 °C steam with a 34% decrease in fossil fuel consumption, 35% reduction in electricity costs, substantial reductions in water and solid waste, and a payback period of 4 years [122]. In the Netherlands, a 1.4 MW ammonia heat pump system supplies 63 °C water, using waste heat recovery to achieve a COP of 5.9 [123].
- Bucher Unipektin. Fruit juice processing using [124, 125]multiple mechanical vapour recompression to replace a thermal vapour recompression system. This resulted in a three-fold reduction in costs to generate steam (to account for losses). Although the new MVR system required a ten-fold increase in electricity consumption, this was outweighed by the cost of steam and ultimately had a two-year payback period.
- Tree Top Food Processing. Heating apples for dehydration in the Tree Top Food Processing Wenatchee, Washington State, USA, facility uses heat pumps to displace approximately 94 MJ of natural gas per annum. Despite not leveraging waste heat or solar PV, the 1.25M USD heat pump had a payback period of less than 3 years [120].

- Islington Council. The Islington Council in London, UK, is working towards net zero emissions by 2030. In an example of district heating, waste heat from the London underground (rail) system, is lifted from 55 °C to 80 °C using a customised 1 MW ammonia heat pump with a COP of 3.5. The system supplies hot water to 1350 homes, two leisure centres and a school [126].
- General Motors [122]. Connecting the Detroit-Hamtramck Assembly facility in Michigan, Detroit, to the local Detroit Renewable Energy plant to replace its onsite coal boiler. The plant uses waste from the City of Detroit to supply steam to the assembly facility at 200 °C. Although this temperature exceeds the low temperature scope of this report, it provides an example of effective industrial process heat generation in conjunction with local municipal authorities. It is also noteworthy that this facility was established using tax-exempt financing and a supplementary natural gas boiler is installed as a back-up unit.

Noticeably, the low uptake of heat pumps for metals and minerals processing is an artefact of their low TRL for producing temperatures above 100 °C. Such heat pumps are, however, in development as prototypes and proof of concept demonstrators to provide up to, or above, 200 °C heat [127], encompassing the 150 °C upper temperature focussed on in this report.

While the above case studies have been driven on a local or business scale, national policies to reduce fossil fuel consumption from process heat generation have been established globally, specifically New Zealand’s current Energy Efficiency and Conservation Strategy 2017 – 2022 [128] targets a decrease in emissions from industrial process heat by one percent per annum. This strategy does not explicitly distinguish between temperature bands, although the New Zealand Ministry of Business Innovation & Employment defines low temperature process heat as below 100 °C, medium temperature between 100 – 300 °C and high temperature as above 300 °C [128].

## 2.5 Survey

### 2.5.1 RACE for 2030 Theme B3 - survey of end users

The survey was designed for nine different sectors: eight manufacturing sectors and one building sector, as shown in Table 4. A sample of the survey, as pertaining to the food manufacturing sector, is provided in Appendix B. Invitations to participate in the survey were sent by A2EP to their mailing list, to members of a predominantly Australian industry reference group (IRG) and research partner organisations. All email recipients were encouraged to pass on the invitation to their networks (i.e. a snowballing recruitment process was implemented). This means that it is not possible to know exactly how many invitations were distributed, but it is estimated to be at least 1600.

Table 4. Industry Survey - Sectors and ANZSIC Codes

Sector	ANZSIC CODE
Food Manufacturing	11
Sugar Manufacturing	118
Meat Manufacturing	111
Beverage Manufacturing	121
Wood Product Manufacturing	149
Paper and Pulp Manufacturing	151, 152
Polymer Product Manufacturing	191
Non-Ferrous Metals Manufacturing	213, 214
Commercial Buildings	No ANZSIC CODE for building operations

Only a small number of responses were received, and there were insufficient responses in each of the sectors to enable independent sector analysis. The very low response rate also means that care must be taken in analysing these results to protect the identity of responding organisations. Care must also be taken in interpreting the information below, as it is representative of the responding organisations and should not be taken as representative of process heat industries collectively or by sector. Section 2.5.2 analyses the responses in general, while Section 2.5.3 provides some insight into sectors, to the extent possible without revealing organisation identities.

## 2.5.2 Survey analysis

### 2.5.2.1 Response categorisation

The responses encompassed 16 sites across four sectors, as shown in Figure 37.

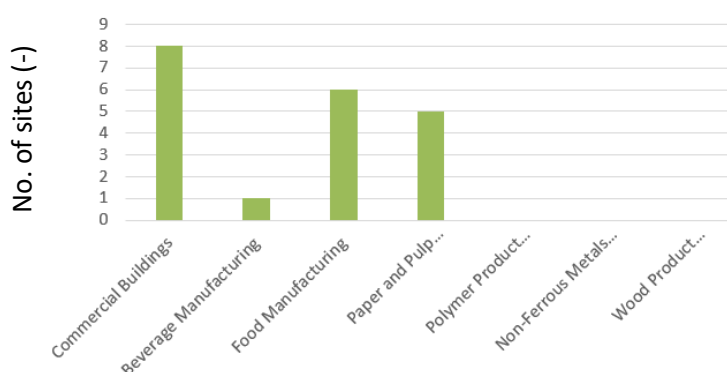

Figure 37. Survey sites by sector

Reasonable diversity was presented within these four sectors, however, as shown in Table 5.

Table 5. Diversity of sub-sections represented in responses

Sector (2 digit ANZSIC CODE)	Diversity (3 or 4 Digit ANZSIC CODE)
<b>Commercial Buildings</b>	Healthcare facilities (8599) Offices (699) Education facilities (810)
<b>Beverage Manufacturing (12)</b>	Beer (1212)
<b>Food Product Manufacturing (11)</b>	Snack Foods (1191) Pet Food (1192) Meat Processing (1111)
<b>Pulp, Paper and Converted Paper Product Manufacturing (15)</b>	Pulp, paper, paperboard (1510) Corrugated paperboard and paperboard containers (1521) Paper bags (1522) Paper stationery (1523) Other converted paper products (1529)

The majority of these sites are in NSW and Victoria, with 2 sites in Queensland and 1 site each in SA and WA (Figure 38). No responses were received from sites in Tasmania, ACT or NT.

## Electrification & Renewables to Displace Fossil Fuel Process Heating

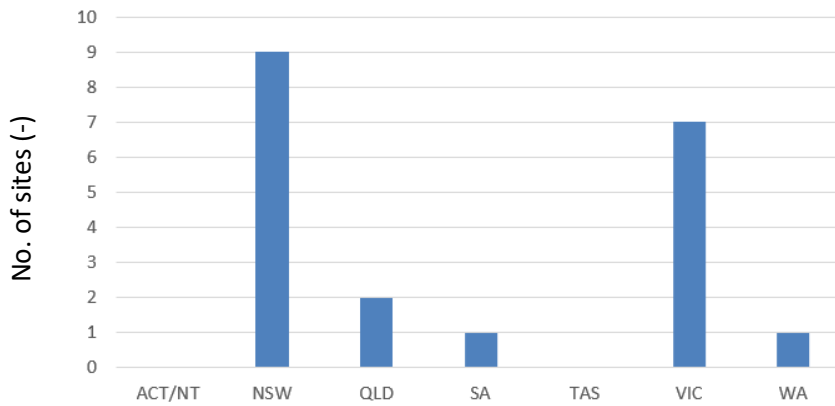

Figure 38. Number of sites per state

No responses were received from small businesses (less than 20 employees). Responses were predominantly related to large organisations or conglomerates (Figure 39).

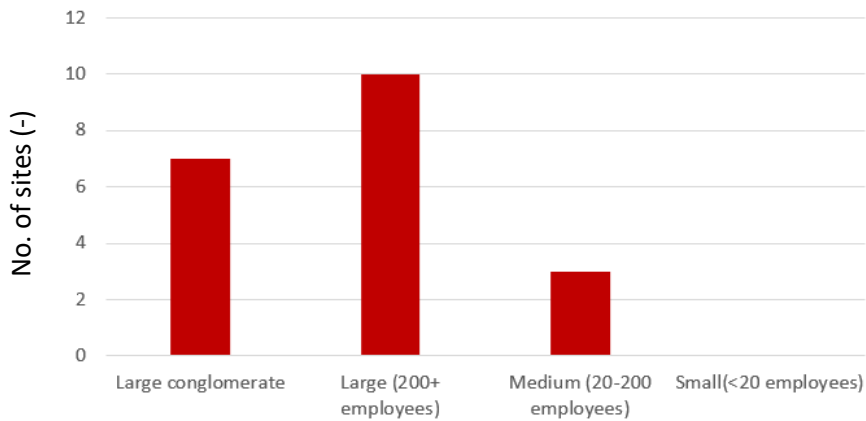

Figure 39. Number of sites by business size

### 2.5.2.2 Future plans and potential for decarbonisation

The survey included questions relating to the long-term goals and plans of the company, as well as site conditions that may provide opportunities for decarbonisation of processes in the short term. This section summarises those responses. Some details of these responses, related to specific sectors, are included in Section 2.5.3.

#### 2.5.2.2.1 Net zero carbon goals

Eight sites represented organisations that had detailed plans to achieve net zero carbon goals. Three sites represented organisations that had aspirational goals for net zero carbon, but with no detailed planning for achieving those goals. Nine sites represented organisations that had no plans or aspirations for net zero carbon. There was no correlation between the size of the organisation and their carbon goals.

#### 2.5.2.2.2 Greenfield development

37.5% of responses indicated that they were considering plans for future greenfield development, with an equal number indicating they had no such plans. 12.5% indicated they were either unlikely to develop greenfield sites or would possibly develop greenfield sites in the future.

### 2.5.2.2.3 Major plant upgrades

62.5% of responses indicated that they were possibly considering major plant or equipment upgrades in the next 10 years, with the remainder indicating they were definitely considering such upgrades.

### 2.5.2.2.4 Onsite refrigeration

Two organisations indicated that they did not have an onsite refrigeration plant. For sites that did have onsite refrigeration, the type of plant included:

- Ammonia-based refrigeration
- Glycol chillers
- Cold rooms (for storage of finished product)
- Building air conditioning plant: central chiller plants 200 kW<sub>r</sub> – 3000 kW<sub>r</sub>; multiple package plant, multiple small air conditioners

### 2.5.2.2.5 End-of-life equipment

Two organisations indicated that they had equipment that was approaching end-of-life in the next three years. This equipment included:

- Ammonia refrigeration plant
- Heat exchangers

One organisation indicated that it was likely they had equipment approaching end-of-life in that timeframe, but they did not know which specific equipment.

### 2.5.2.2.6 Consideration of alternative technologies

All responses, except one, indicated that they had considered alternative technology options in the last three years. Information provided in the survey ranged from general to specific, and from investigation to implementation. For example:

- Yes, ongoing review
- Yes, full analysis of alternate energy
- Yes, energy from waste: pending investigation
- Yes, biogas: looking at the option
- Yes, currently installing a biomass boiler at one site
- Yes, considering heat pumps instead of gas-fired, however space/capital cost vs usage is regularly a barrier
- Yes, looked at heat pump technology but didn't have the volume to make it viable for implementation

### 2.5.2.3 Financial decision mechanisms

A range of financial mechanisms were used to determine the economic viability of a project such as a plant upgrade (Figure 40). The two most common of these were payback and net present value. Some organisations used a mixture of mechanisms, such as payback period combined with capital cost (seen as a constraint). There was no correlation between the size of the organisation and the financial mechanism used.

One organisation indicated that they considered both financial and sustainability metrics in making their investment decisions. They did not elaborate on what these metrics are.



## Electrification & Renewables to Displace Fossil Fuel Process Heating

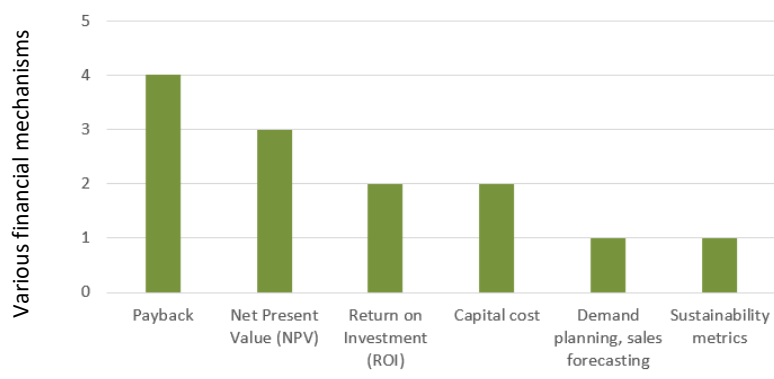

Figure 40. Financial mechanisms used for determining economic viability of technical projects

### 2.5.2.4 Barriers and opportunities

The survey asked organisations to indicate what they considered were the main barriers (or opportunities) to decarbonising low temperature heat processes (defined as <150 °C). The collective responses have been categorised as:

- Technical (e.g. alternatives that can provide the required temperature, access to that technology)
- Financial (e.g. access to capital; capital cost (CAPEX); CAPEX vs value of existing assets; gas vs electricity price)
- Knowledge (knowledge about options or how to make the change; local expertise; technical/design experience)
- Process (e.g. the retrofit process involves large amounts of plant, space and cost)
- Temperature range (processes in the range of 150 – 185°C)

There was no obvious correlation between the types of barriers identified and the size of the organisation (i.e. organisations of all sizes appear to face similar barriers).

### 2.5.2.5 Energy

This section summarises general information about energy sources, energy use and prices across all sites. For this summary, responses were put into three broad sectors: buildings, food and paper (Table 6). Off peak refers to time during the day when energy is in abundance and demand is low, usually resulting in discount prices. Peak refers to time during the day when demand requires more energy than available, resulting in the use of carbon fuels. Shoulder refers to times between peak and off-peak. More detailed sub-sector specific information is provided in Section 2.5.3.

## Electrification & Renewables to Displace Fossil Fuel Process Heating

Table 6. Summary of energy information across three broad sectors

Category		Buildings	Food	Paper
<b>Energy sources</b>		Natural gas Biomass Electricity	Natural Gas Electricity Oil (cooking oil)	Natural Gas Diesel Biomass Electricity
<b>Energy Use</b>	Gas (GJ)	2585 - 40000	150 (GJ) / 23000 Litres	8500000
	Electricity (MWh)	Not provided - 3000	100 - 10000	5000
<b>Energy prices</b>	Gas	\$0.011 – 0.027 MJ	Not provided - \$0.64 MJ	Not provided
	Electricity	Not provided \$0.1 – 0.15 kWh (off peak) \$0.15 (shoulder) \$0.18 – 0.26 kWh (peak) \$6-10 network demand charge	Not provided \$0.047 kWh (off peak) \$0.09 (peak) \$0.32 daily charge \$0.04 off peak charge \$1.45 KW peak demand	Not provided
<b>Contracts</b>	Gas		Take or pay	Take or pay
	Electricity		PPA <sup>1</sup>	PPA <sup>1</sup>
<b>Contract timeframe</b>		Up to 2022	Up to 2040	Multiple, 2025+

<sup>1</sup> Power purchase agreement

Most manufacturing organisations indicated that they had at least one energy contract, beyond standard industry tariff options. It was not uncommon for organisations to have both gas take-or-pay contracts and electricity power purchase agreements. One medium-sized manufacturing organisation did not have a contract for gas or electricity. The only organisations that provided price data were those not on a contract. This would seem to indicate that the contracts themselves may have non-disclosure clauses that limit the sharing and disclosure of energy prices paid per organisation.

Only a few organisations provided energy usage data, so the figures in this table are not indicative of the sector, but represent the actual figures, or ranges, provided in the responses.

### 2.5.2.6 Plant and process operation

The survey sought to understand the specific processes within each sector, the temperature ranges required for these processes, and the duration and scheduling of these processes. Rather than provide a generalised evaluation of all responses, the specific responses are provided in Section 2.5.3 to the extent possible without revealing the identity of specific organisations.

### 2.5.3 Sector insights

This section provides some insights into the low (and medium) temperature process heat needs and operations of organisations in specific subsectors. The information provided here is specific to an organisation / site and should not be taken as representative of the subsector. Nevertheless, the information provides further insight into specific processes, especially with regard to processes in low and medium temperature ranges, the equipment used, and the duration and scheduling of these processes.

## Electrification & Renewables to Displace Fossil Fuel Process Heating

### 2.5.3.1 Pulp and paper

This sector appears to consist of continuous processes that operate 24 hours/day each day of the week. The responses provided in the survey are shown in Table 7. The three major barriers identified for this sector were:

- “Cost of decarbonised thermal energy is currently not competitive (e.g. electricity costs and efficiency of conversion vs natural gas costs)”
- “Existing infrastructure still has life and new CAPEX cannot be validated”
- “Technology to produce heat at high enough temperature[s] economically”

Table 7. Pulp and paper low and medium temperature heat processes

Process	Drying	Drying
Temperature range*	95-150 °C	150-250 °C *predominant thermal delivery is 150-180 °C
Primary energy source	Natural Gas Electricity Biomass Diesel	Natural Gas Biomass Diesel
Secondary energy form/s	Steam Heat applied directly to material	
Process type	Continuous	
Typical processing days	7 days/week	
Typical processing times	24 hours	
Flexibility in timing of process?	Unlikely	
Main processes	Drying and pulp “cooking”	
Floor area potentially available for thermal storage	>20m <sup>2</sup>	
Have process energy flows been mapped?	Don’t know	
Do you use waste heat recycling or waste heat recovery?	Yes	

As a large energy user, it is likely that organisations in this sector have both gas and electricity contracts that extend for multiple years (perhaps at least five years). Note that electricity is currently only used for drying processes up to 150 °C.

### 2.5.3.2 *Snack foods*

The following is the response from one organisation. It should not be taken as indicative of the whole sector. Table 8 summarises the key heat processes for this organisation. It operates continuously from Monday through to Saturday. Natural gas is the primary energy source. The main equipment (gas-fired heat exchangers) is approaching end of life, so it is “possible” that the organisation will undertake major plant upgrades in the next 10 years.

Table 8. *Snack foods medium temperature heat processes*

Process	Cooking	Drying	Washing/Cleaning
Temperature range*	150-250 °C *predominant thermal delivery is 185 °C	150-250 °C	
Primary energy source	Gas + Cooking oil	Natural gas	Natural gas
Secondary form of energy		Heat applied directly to material	Heat applied directly to material
Process duration	>12 hours	>12 hours	1-6 hours
Typical processing days	Mon – Sat	Mon - Sat	Sunday
Typical processing times	24 hours	24 hours	06:00 – 12:00 12:00 – 18:00
Main equipment			Gas fired heat exchanger > 180 °C
Flexibility in timing of process?			Definitely not
Floor area potentially available for thermal storage			>20m <sup>2</sup>
Have process energy flows been mapped?			Yes, mass and energy balances (PFDs)
Do you use waste heat recycling or waste heat recovery?			Not sure

### 2.5.3.3 *Pet food*

The following is the response from one organisation. Table 9 summarises the main processes used by this organisation. Major plant upgrades are a possibility.

Table 9. *Pet food manufacture low temperature heat processes*

Process	Cooking	Sterilisation
Temperature Range	95-150 °C	95-150 °C
Primary energy source	Natural Gas	Natural Gas
Secondary form of energy	Steam	Steam
Process duration	Continuous	Continuous
Typical processing days	Mon - Fri	Mon - Fri
Typical processing times	24 hours	24 hours
Flexibility in timing of process?		Definitely not
Main equipment		Boiler
Floor area potentially available for thermal storage		Not sure
Have process energy flows been mapped?		Yes, Sankey diagram + PFDs
Do you use waste heat recycling or waste heat recovery?		Yes

## Electrification & Renewables to Displace Fossil Fuel Process Heating

### 2.5.3.4 Meat processing

The following is the response from one organisation. Table 10 and Table 11 show the heat processes, scheduling and opportunities reported in this response.

Table 10. Meat processing low-mid temperature heat processes

Process	Slaughter	Hide Processing	Paunch processing and offal washing	Rendering and blood processing	Boning	Washing
Temperature range*	95-150 °C	<95 °C	95-150 °C	95-150 °C / 150-250 °C	<95 °C	95-150 °C
Primary energy source	Natural gas	Electricity	Natural gas	Natural gas	Electricity	Natural gas
Secondary form of energy	Water		Water	Steam, Water, Directly applied heat		Water
Process type	Continuous					
Process duration	6 – 12 hours					1 – 6 hours
Typical processing days	Mon – Fri					
Typical processing times	00:00 – 18:00					12:00 – 24:00

Table 11. Meat processing potential opportunities

Is there flexibility in the timing of processes?	Unlikely
What floor area is available for thermal storage?	Not sure
Have process energy flows been mapped?	No
Do you use waste heat recycling or waste heat recovery?	Yes: heat from steam produced from gas boilers is passed through multiple heat exchangers to provide site with 90 °C and 40 °C water.
Do you have refrigeration on site?	Ammonia-based refrigeration; due for replacement
Are you investigating any renewable energy options?	Biogas

## Electrification & Renewables to Displace Fossil Fuel Process Heating

### 2.5.3.5 Beer manufacture

The following is the response from one organisation. Table 12 and Table 13 show the heat processes, scheduling and opportunities reported in this response.

Table 12. Beer manufacturing process heat summary

Process	Mashing	Boiling	Sanitisation	Sterilisation	Drying
Temperature range*	<95°C				
Primary energy source	Natural gas, electricity				
Secondary form of energy	Water		Water	Water	Water
Process type	Batch		Batch	Batch	Batch
Typical processing days	Tues, Thurs	-	Mon – Sun	Mon, Wed, Fri	Mon – Fri
Typical processing times	06:00 – 18:00	-	00:00 – 24:00	06:00 – 18:00	06:00 – 18:00

Table 13. Beer manufacturing potential opportunities

<b>What is the main equipment?</b>	<b>500kW boiler to heat water that is then used in the brewing process and for site cleaning during and post batch production</b>
<b>Is there flexibility in the timing of processes?</b>	Perhaps – will need some investigation
<b>What floor area is available for thermal storage?</b>	4-20m <sup>2</sup>
<b>Have process energy flows been mapped?</b>	No
<b>Do you use waste heat recycling or waste heat recovery?</b>	Yes, heat recovery from brewing process that is used to put back into heating the water such that it reduces the requirement of LPG to heat water via steam generation.
<b>Do you have refrigeration on site?</b>	Yes, glycol chiller 60kW for the fermentation control. Also a warehouse coolroom for finished product storage.
<b>Are you investigating any renewable energy options?</b>	Yes, we looked at heat pump technology but we did not have the volume to make it viable for implementation.

### 2.5.3.6 Commercial buildings

Table 14 shows the five heat processes used across the three different types of commercial buildings that responded to the survey (offices, education, health care). Gas and electricity were the main energy sources. Processes were continuous but for short durations (because building heat needs are typically thermostat controlled). There were no typical ‘processing’ days or times, as it depended on building occupancy (e.g. offices vs health care).

## Electrification & Renewables to Displace Fossil Fuel Process Heating

Table 14. Commercial building process heat summary

Process	HVAC water heating	Sanitary water heating (e.g. bathrooms)	Domestic hot water (e.g. kitchen, laundry)	Sterilisation	Drying
Temperature range*	<95°C	<95°C	95-150 °C(?)	150-250 °C	
Primary energy source	Natural gas, LP gas, electricity (only for up to 95°C)				
Secondary form of energy	Water	Water	Water	Steam	Air
Process type	Continuous	Continuous			
Process duration	≤ 1 hr - >12 hrs	1-6 hrs	1-6 hrs	6-12 hrs	6-12 hrs
Typical processing days	Depends on building type; may be Mon-Fri or may be Mon-Sun				
Typical processing times	Depends on building type				

- The predominant heating needs in buildings are low temperature (<95 °C) with some higher temperatures needed for some activities (e.g. in laundries, or for sterilisation using autoclaves).
- Some sites identified that they used air heat exchangers to recover energy from the exhaust air stream.
- One respondent considered that energy storage (thermal/batteries) and on-site solar would likely be the best technology (for their building type) to reduce grid usage and spread demand.
- Another respondent (healthcare sites) mentioned that space heating and hot water are major costs for the health industry in their part of Australia, particularly if they did not have access to natural gas.

### 2.6 Discussion and Recommendations

Several of the highest process heat users were reviewed. The information was synthesised to expedite guidance to collaborators undertaking different sub-tasks in the opportunity assessment.

Simplified PFDs were generated to elucidate where low temperature process heat is required in Australian industry (<150 °C), how that heat is supplied, and where waste heat is available. The simplified PFDs presented in this report is for a 'typical' process and the available information, using publications from Australian organisations where possible (e.g. Australian Meat Processing Corporation) and drawing on the open literature. However, in practice, the implementation of the process will vary from site-to-site based on local conditions (e.g. available feedstock quality and geography), resulting in minor variations to unit operations and operating conditions from that presented.

For the processes explored, which covers a significant proportion of the low temperature process heat users, the primary heat source was almost ubiquitously natural gas with supplementary firing coming from coal (meat and alumina), with pulp and sugar processing using some of its available biomass derivatives for energy (black liquor and bagasse). In all instances, energy was either supplied by steam

## Electrification & Renewables to Displace Fossil Fuel Process Heating

boilers and hot water heaters (commercial buildings and food processing). Instances were found of steam-heating air rather than direct electrical heating, due to the on-site boiler (dairy). Table 17 provides a general overview of discussed sectors with the specific unit operations, the type of fuel used for heating and heat intensity. All the unit operations are discussed in the corresponding section.

*Table 15. An overview of discussed sectors for process heating in this report.*

Unit operations	Temp. range	Major heating source/Technology	Heating intensity <sup>1</sup>
<b>Alumina Production</b>			
Digestion and clarification	100-180°C <sup>2</sup>	NG-coal/steam boiler	2.8-3 GJ/t Alumina
Evaporation	70-100 °C	NG-coal/steam boiler	1.3-1.5 GJ/t Alumina
Precipitation	60-80 °C	NG-coal/steam boiler	~ 0.1 GJ/t Alumina
<b>Wood Processing</b>			
Kiln drying	40-75 °C	NG/wood waste	2-3 GJ/ t lumber
<b>Pulp Production (kraft pulping)</b>			
Evaporation	60-120 °C	NG-wood waste-black liquor/ steam boiler	3-4.3 GJ/ t pulp
Pulp drying	40-55 °C	NG-wood waste-black liquor/ steam boiler	2.5-3.5 GJ/ t pulp
Bleaching	30-90 °C	NG-wood waste-black liquor/ steam boiler	2.3-3.2 GJ/ t pulp
Digestion	65-175 °C	NG-wood waste-black liquor/ steam boiler	2.2-3 GJ/ t pulp
<b>Paper Processing</b>			
Paper drying	70-90 °C	NG/steam boiler	3.5-4.7 GJ/ t paper
Stock preparation	40-100°C	NG/steam boiler	0.7-0.9 GJ/ t paper
Forming and pressing	40-50 °C	NG/steam boiler	0.3-0.4 GJ/ t paper
<b>Dairy Processing (Milk powder)</b>			
Spray drying	80-200 °C	NG/ steam-heated air	3.7-5.8 GJ/t Milk powder
Pasteurisation	80-120 °C	NG/ steam boiler	0.9-1.4 GJ/t Milk powder
Pre-evaporation	65-75 °C	NG/ steam boiler	0.4-0.6 GJ/t Milk powder
Cleaning in place	60-70 °C	NG/ steam-heated water	0.3-0.5 GJ/t Milk powder
<b>Dairy Processing (Other value-added products)</b>			
Cheese Processing	70-110 °C	NG/ steam boiler-hot water	~1.3 GJ/t milk
Butter Processing	70-110 °C	NG/ steam boiler-hot water	~1.2 GJ/t milk
Yoghurt Processing	70-110 °C	NG/ steam boiler-hot water	~0.7 GJ/t milk
Milk processing	70-110 °C	NG/ steam boiler-hot water	~0.2 GJ/t milk
<b>Meat Processing<sup>3</sup></b>			
Rendering	115-145 °C <sup>4</sup>	NG-coal/ steam boiler	~ 1.7 GJ/ tHSCW
Sterilisation and cleaning	110-130 °C	NG-coal/ steam-heated water	~ 0.28 GJ/ tHSCW
Blood processing	43-82 °C	NG-coal/ steam boiler	~ 0.19 GJ/ tHSCW



## Electrification & Renewables to Displace Fossil Fuel Process Heating

Unit operations	Temp. range	Major heating source/Technology	Heating intensity <sup>1</sup>
<b>Beer Production<sup>5</sup></b>			
Hop boiling in kettle	95-100 °C	NG/ steam boiler	0.4-0.7 GJ/kL beer
Pasteurisation and packaging	60-70 °C	NG/ steam boiler-hot water	0.2-0.4 GJ/kL beer
Cleaning in place	70-90 °C	NG/ steam-heated water	~0.2 GJ/kL beer
Mashing	45-75 °C	NG/ steam boiler-hot water	~0.1 GJ/kL beer
<b>Commercial and Services (Hospitals)</b>			
Water heating in hospitals	60-80 °C	NG/ water boiler	195-225 MJ/patient day
Steam heating in hospitals	170-190 °C	NG/ steam boiler	130-140 MJ/patient day
<b>Commercial and Services (Hotels, Aged care facilities)</b>			
Water heating in Hotels	55-80 °C	NG/ water boiler	8.9-11.9 MJ/ day
Water heating in aged care facilities	50-80 °C	NG/ water boiler	8.9-11.9 MJ/ day
11: Due to the difference in unit, the heat intensity scale for commercial and services is different. 2: The temperature range in east coast refineries is 100-280 °C. 3: tHSCW is tonnes of hot standard carcase weight. 4: Nowadays more rendering plants are shifting to low temperature rendering with temperature range 70-100 °C 5: The heat intensity unit is expressed in GJ/kL beer for better data illustration.			

There are significant amounts of low temperature heat used in food processing generally, with milk powder a particularly high consumer, making it a key sector to explore further. Brewing (hop boiling), dairy (spray drying and pasteurisation) and meat (rendering and sterilisations) were all considerable users of low temperature heat. For commercial buildings, hospitals are particularly highlighted for their high consumption. For pulp production, although evaporation of black liquor is a key area for low temperature process heating, it is predominantly supplied by combustion of black liquor, a derivative of the wood feedstock. In contrast paper production and wood processing use relatively high amounts of natural gas for its low temperature heat use. For alumina processing, digestion and clarification as well as evaporation are other areas for decarbonising low temperature process heat.

More feedback was received in relation to commercial buildings, food and pulp & paper sub-sectors. The feedback of the surveys was mostly consistent with the PFDs generated independently. In some processes, PFDs did not always well capture the nature of batch processing operations and those requiring shift work, for example the nature of shift work patterns for in snack food manufacturing (Table 8) and meat processing (Table 11). Review and feedback was also gratefully received from the Industry Reference Group in relation to alumina and meat processing and improvements were integrated into the PFDs.

From the limited survey responses, payback and NPV were the most common metrics for financial decision making. The barriers to decarbonisation were grouped as technical, financial, knowledge, process and temperature range.

The scope of the project was to investigate process heat demand for <150 °C, however the boiler systems used in many process industries using this process heat temperature, also use process heat in the 150-250 °C range, so this was also captured where relevant.

### *2.6.1 Research gaps, barriers, and opportunities*

According to the literature review, all 'typical' processes were found to have sources of waste heat, however it is not known whether all factories currently have heat integration, which may be an opportunity for further investigation. In addition, a detailed pinch analysis is an appropriate method for assessing the potential of utilising waste heat for different industries which has not been investigated in this report.

The response rates for the survey were low and although a reasonable spread of processes were covered, there was only one response for most sub-sectors and so therefore responses should be regarded with caution. Another approach for generating industry practice and data could be considered for future studies. Interviewing industry on-site and/or conducting a preliminary energy audit in various departments (R&D, process, finance) may be considered to obtain more complete feedback than the survey tool deployed.

Processes with lower process uniformity were not analysed for this report as they constituted a lower proportion of heat use. The short duration of the opportunity assessment, and the temperature range, limited the number of processes investigated. It is suggested to expand this to include other low temperature process heat users which may not have a uniform process operation such as ready to eat meals, agriculture, forestry, and fishing, although the latter has not a significant share of Australia's process heating consumption.

Although the current available resources about the temperature distribution for process heating in different industries (such as Table 1 in the ARENA report [2]) is a good starting point, it must be used with care for more in-depth analysis. This study identified that further in-depth investigation could be performed to provide more certainty about the amount of low temperature heat used in several sectors, particularly paper – where natural gas is used extensively – and for alumina processing which uses low temperatures for evaporation. In addition, this study has not reported the temperature distribution and heat intensity distribution in the commercial and services sector process heating. To the best of the authors' knowledge, there are few studies concerning the commercial and services sector process heating intensity and temperature range. Due to significant annual heating demand (e.g., ≈61 PJ in 2018-2019), more detailed research based on temperature and heating range is vital.

Following PFD definition, good process simulation and process economics modelling tools are essential for investigating improvements to overall process efficiency. In our investigation, process modelling tools designed for substituting fossil fuel-based heating with renewable technologies was not elucidated. Further work to create and adapt new tools for simulating the substitution of fossil fuels with renewable technologies is warranted. Similarly, the environmental consequence of implementing technologies with an effect on global warming potential (GWP) could also be developed.

Location can play a significant role in process heat electrification which has not been investigated in detail in this study due to time and resources constraints. Proximity to the power grid and applicability of current power grid to provide the required load after electrification can vary by location. Subsequently, a geographically based energy analysis for the larger heating consumers across Australia would be informative. In addition, the possible effect on electricity price should be considered. The emissions reported by National Pollution Inventory (NPI) would be a valuable starting point for geographical-based energy consumption (including heating). However, more in-depth energy consumption analysis (e.g., GIS-based simulation and data mining) by combining the data obtained from NPI, Australian Bureau of Statistics, Australian Energy Statistics (AES), National Greenhouse, and Energy Reporting Scheme (NGERS), and Geosciences Australia would be helpful.

Although most processes (e.g. alumina processing, pulp processing) are continuous, and so have only modest variations in electricity consumption, it would be quite helpful to analyse the electricity/fuel load profile consumption for batch industries (e.g. meat processing and brewery). However, more information is required. This analysis would be challenging since it could be affected by various key parameters such as plant capacity factor, shift cycles (labour), the availability of electricity load and market demand.

### **Barrier: Technology integration**

- A thorough analysis of best available process integration options for current plant configurations is required to improve the energy efficiency and potential for electrification for most industries (e.g. pinch analysis).
- Further work is then required to productively use remaining waste heat with new technology (e.g. heat pumps, MVR).

### **Barrier: Insufficient data and tools**

- There is a need for specialised process modelling software/tools for new technologies.
- There is little detailed industry-based process information (temperature profile, pressure, working hours), particularly for batch processes.
- Heating for processes with lower process uniformity (textile, agriculture, ready to eat meals etc.) requires relatively greater resources and more complex methodology.
- More reliable information is needed for the energy used for heating at each temperature for most sectors, particularly commercial buildings, and services.
- There is insufficient information of the proportion of energy used at each temperature range for various sectors.
- More information is needed regarding fuel and electricity consumption and cost variations.

### **Barrier: Impacts on grids**

- The literature suffers from a lack of geographical based energy/heating consumption across various industries to assess the potential implications for individual Australian factories.
- There is insufficient information about peak electricity consumption for batch processes (e.g. brewery, meat processing), which constitute a minority of the processing industries.

### *2.6.2 Future research*

Before applying any relevant electrification of renewable energy, it is recommended to improve energy efficiency using the best available techniques. While many studies are developed and published internationally, such as reported studies by European Union, Australian industry suffers from insufficient energy efficiency reports except for some studies developed by sector organisations, such as AMPC and Dairy Australia. Subsequently, more in-depth studies are required to boost the following aspects of energy efficiency and electrification:

1. Engage with relevant stakeholders to elucidate factory-specific PFDs.

## Electrification & Renewables to Displace Fossil Fuel Process Heating

2. Create process simulation models for relevant industries to determine the mass and energy balances across a typical site using appropriate software (e.g. Aspen, HYSYS, Pro/II, AQMB).
3. Develop algorithms and modelling tools for incorporating new technologies into process models.
4. Conduct pinch analysis for finding some fuel economy measures.
5. Review, shortlist and compare technology options for reviewing site-wide fossil fuel-based energy reductions, including economics.

In addition, life cycle analysis would be beneficial for selecting the most environmentally friendly option. This suggestion would help in selecting the best process upgrading option by integrating the energy efficiency improvement (e.g. by pinch analysis) and renewable energy technologies (or electrification) for heating. On current available information, new tools could be developed for renewable low-temperature heating in alumina refineries, food subsectors (meat processing, dairy processing, breweries), and the pulp and paper industry. The commercial and services sector is another example of excellent potential for low-temperature heating in various applications, e.g., hospitals, aged care facilities, hotels, and other places such as commercial kitchens.

## 3 Technology Overview

### 3.1 Introduction

Heat is traditionally provided by a fuel source, typically natural gas but also LPG and diesel. This source, in a decarbonising world, is no longer a viable strategy for commercial and industrial heat processes no matter how low cost it is. With low cost renewable electricity becoming abundant in Australia, the opportunity to deliver low cost heat has attracted the attention of technology developers and industries [129]. As a result, a technology review to investigate this opportunity to electrify heat within Australia is beneficial.

This review considers a range of technologies relevant to the electrification of heat at the full range of Technology Readiness Levels (TRL). This review focuses on heat applications from 95 °C to 250 °C for commercial and industrial (C&I) users. Focus has been on providing heat rather than alternative processing methods (e.g. UV sterilisation, reverse osmosis).

### 3.2 Hybridisation

In eastern Australia, wholesale natural gas prices combined with network charges are around \$10/GJ or \$43/MWh<sub>th</sub> while diesel and LPG prices are around \$35/GJ or \$126/MWh<sub>th</sub> [130, 131]. The trend in fuel prices has either been to remain steady or increase over time. The electrification of heat with renewable energy has the potential to become a viable commercial option due to the dramatic reduction in cost of renewable electricity over the past two decades. Furthermore, by using electricity, which is ubiquitous, it enables the use of solar, wind and other renewable electricity generators which collectively deliver electricity more continuously, and is better suited for heating processes. In South Australia (SA), with more than 60% of electricity consumption from renewable electricity, electricity commercial contract import prices have been as low as \$55/MWh [132]. Adding network charges this translate to around \$95/MWh<sub>th</sub>. Combined with behind the meter renewable energy generation (principally solar PV) and energy efficient heat delivery technologies such as heat pumps potentially offers a low cost of heat. Both concentrating and non-concentrating solar thermal technologies (CST/ST) over the past two decades have dramatically reduced in both cost and improved in performance [1]. Consequently, with a decreasing cost of heat from both electricity and thermal derived renewable energy, coupled with a constant or increasing price of fossil derived heat, it is conceivable that the cost of heat from renewable energy will be a lower cost source of heat than fossil fuels.

An important consideration for commercial and industrial (C&I) users is that heating is often conducted continuously. Furthermore, the various technologies available ranging from different renewable energy generators, energy storage (both electric and thermal), hydrogen generators and biogas production, provide a complex multitude of options, making it difficult for end users and designers to identify a suitable solution. C&I customers require a strategy to ensure each technology investment is not stranded by future choices towards a 100% decarbonisation solution. Because of this, a 100% renewably driven energy solution, can often be elusive.

100% renewable energy studies have shown the importance of hybridisation, where each technology is used to its advantage, mitigating the disadvantages of other technologies. Elliston et al. [133] identified the least cost 100% renewable electricity grid for Australia resulting in 66% of the energy provided by variable renewable energy followed by 27% dispatchable renewable energy with the remaining 6% delivered using a high cost renewable fuel. This result is consistent with recent 100% renewable energy studies for Germany [134, 135] and involves a strong focus on the electrification of heat. These studies highlighted the strategy of hybridisation, in which energy production is driven by

renewable electricity incorporating energy storage, with small amounts of renewable fuels delivering the remainder. An important component of this remainder is met through the power-to-X strategy. By 2025 the EU will have around 500 MW of gas production through this process [136].

This research can be distilled into a hierarchy of renewable energy as presented in Figure 41 and is applicable to both electricity and heat. The separation of categories is identified by the techno-economics of each technology. This renewable energy hierarchy can be characterised by each category representing increasing cost with increasing dispatchability with decreasing amounts of electricity provided.

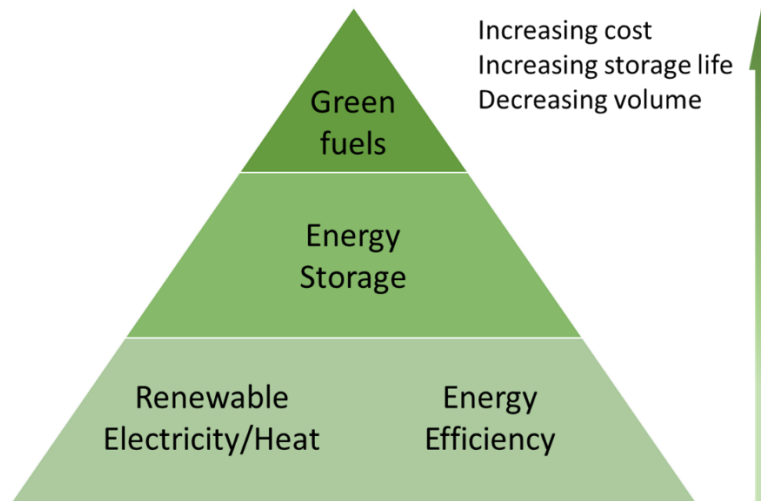

Figure 41. Hierarchy of renewable energy use by technology for 100% renewable energy solution for end user.

Most energy is directly delivered through base renewable energy, essentially flooding supply to the grid and/or the customer. This is counterbalanced by energy efficiency technology. From an overall techno-economic perspective adding more on-site solar (solar PV or solar thermal) for a customer could prove more financially optimal than improving the technology or process efficiency. In any case this bottom section represents the lowest cost of electricity or heat, defined by the lowest Levelised Cost of Electricity (LCOE) or the Level Cost of Heat (LCOH), respectively.

The second category is energy storage which provides dispatchable power or heat to meet the demand at other times. By definition, the energy delivered through this process is of a higher LCOE/LCOH as it includes the cost of both the renewable energy generator (electricity or heat) and storage. Consequently, less of the energy used is transferred through storage than directly by renewable energy generation. Maximum economic value is achieved through daily charge/discharge cycles.

The 100% renewable energy studies highlight that to achieve 100% with only renewable energy generation and storage results in significant over capacity. Ultimately, an amount of renewable energy capacity and storage is minimally used. This overcapacity increases LCOE/LCOH to uneconomic levels being subject to the principle of diminishing returns. This can be readily reduced using fuel which has relatively lower storage costs and can be discharged using conventional engines or fuel cells, in the case of electricity, or boilers/burners, in the case of heat, which are also of low capital cost. Representing a low amount of energy in absolute terms, the customer can tolerate a high price, but still achieve an overall economic LCOE/LCOH. Not surprisingly this is consistent with an off-grid renewable energy solution which maintains a diesel generator for backup.

Ultimately, this final layer is a form of seasonal storage, and for the 100% renewable energy system can be met by green fuels. Green fuels include green diesel, hydrogen, and green methane. These fuels can be characterised as being of low available supply and high cost. However, given its small volume, it will have a small absolute cost and therefore can deliver the 100% renewable energy solution to the customer at the least cost.

For almost any customer, the line between each category and therefore the sizing of each component is defined techno-economically, but overall can deliver a robust 100% renewable energy solution. This approach has economic advantages as the same infrastructure can be used to meet both electricity and heat demand, specifically on-site renewable energy (electricity or heat) generation and green fuel supply. The following technology review will focus on technologies in each category in Figure 41. Initially, a general overview of green fuels is also provided for the provision of residual heat.

### 3.3 Green Fuels

Green fuels are defined as sustainably derived fuels such as green hydrogen, green diesel, and green methane. Although briefly summarised here, sustainable fuels are a major focus of the RACE for 2030 B5 theme, “Onsite anaerobic digestion for power generation and natural gas/diesel displacement.”

Green diesel or hydrotreated vegetable oil (HVO) diesel is made from vegetable oils, used cooking oil or animal fats and is a direct drop in diesel [137]. The price of this fuel is around 2 times that of the feed stock [138], totalling \$2.6/L. Having longer shelf life than regular diesel, it is a low risk option, however, attracts prices around \$74/GJ. It is therefore ideally suited as a backup source for heating in remote areas, where usage is low.

Green hydrogen from renewably driven electrolysis attracts significant attention and will likely represent a large global mechanism for the delivery of green energy for heat and power in the future. Significant projects around Australia are underway [139], not to mention recent media announcements from Fortescue Metals Group to produce an equivalent of 500 GW of hydrogen, twice the electricity used in Australia. Predictions are that this fuel will match Australian natural gas prices in 2050. Current prices are comparable to LPG around \$50/GJ [140]. However, in relation to the delivery of heat, the biggest factor related to hydrogen is its ability to make use of existing gas pipeline infrastructure [141], through gas grid injection. Natural gas pipelines are able to store months of energy demand and up to 20% of hydrogen mixtures.

Green methane can be made from methanated green hydrogen; however, the lowest cost product is derived from biomethane. Enea’s report [142] showed that the potential for bio-methane in Australia is 500 PJ or 30% of current natural gas usage. Like hydrogen, green methane has an advantage of being able to be gas grid injected essentially without concentration limits. In addition, biogas can be upgraded with electrolysed hydrogen, resulting in approximately double the amount of green methane produced.

Self-consumption of biogas represents an interesting economic challenge as biogas can be converted to green hydrogen attracting a higher price. Therefore, it is possible to generate green hydrogen and/or methane inject into the grid and use later. This could represent a backup or supplementary usage to meet heating needs. Following substantial deployment in Europe, biomethane grid injection has significant potential in Australia [13].

Fundamentally the use of green fuels for heating will need to consider increased demand of these fuels with global decarbonisation strategies. Frugal use of these fuels in any hybrid energy system seems a prudent approach, while a focus on deriving most heating of a C&I process through direct electrification.

### 3.4 High TRL Technologies

This section provides a review of technologies relevant to the electrification of heat with renewable energy focusing on high Technology Readiness Levels (TRL). Specific focus is on TRL 8-9 and above, including the technology which is commercially available.

#### 3.4.1 Energy efficiency

Traditionally, heating processes rely on a fuel to either heat air or produce steam. Heated air and steam are therefore the most common heat transfer fluid (HTF) in C&I processes. This approach relates to the development of industrial processes and the convenience of access to air and water. Therefore, high TRL technologies that can be immediately implemented tend to deliver heat through these HTFs. With regards to energy efficiency technologies, this encompasses heat pumps, heat recovery and heat exchangers and direct electric heating.

##### 3.4.1.1 Heat Pumps

There has been a continuous drive to increase the operating temperature of heat pumps. Figure 42 presents the classification of different heat pumps. The classic vapour compression heat pump maximises the COP if the temperature lift and subsequent pressure ratio is minimised. Therefore, heat pumps are well suited where a waste heat source exists. Globally hydrofluorocarbons (HFCs) are being phased out under the Kigali Amendment to the Montreal Protocol, and as a result, significant attention is placed on natural and low global warming potential refrigerants.

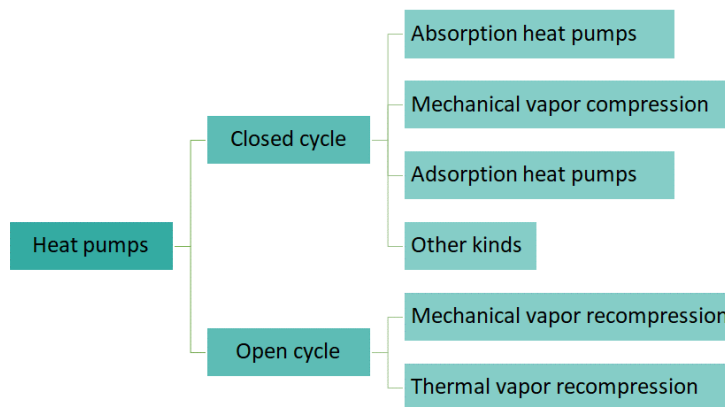

Figure 42. Classification of different heat pumps, adapted from Wu et al. [143].

Higher temperature heat pumping requires a higher critical temperature to enable sufficient latent heat of condensation to provide efficient high temperature heating. Typical HFCs used for heating and cooling such as R134A, R410A have a critical temperature of 101 °C and 73 °C respectively. Hydrofluoro-olefins (HFOs) are new refrigerant formulations which have been specially developed with low global warming potential. New high temperature heat pumps are using HFOs such as HFO-1336mzz-Z with a critical point of 171 °C. They are formulated from the development of organic Rankine cycles and therefore well suited as high temperature heat pump refrigerants.

Table 16 provides an overview of high temperature heat pump suppliers, updating from [127]. The table presents three groups of systems; ammonia systems, which has a critical temperature of 132 °C delivering temperatures under 100 °C (an example unit is shown in Figure 43), CO<sub>2</sub> systems delivering 120 °C and HFO systems delivering higher temperatures. These systems are also combined as cascade systems where the HFO is the secondary refrigerant. However, verification of these high temperature



heat pump suppliers is required, as Viking Heating Engines does not offer these high temperature heat pumps as of Feb 2021.



Figure 43. Example of an ammonia high-temperature heat pump manufactured by Mayekawa [144].

Of note is the opportunity for CO<sub>2</sub> systems. CO<sub>2</sub> having a critical temperature of 31 °C has already been developed to operate in both subcritical and trans-critical states. In this later state, rather than the refrigerant condensing, it is cooled as a supercritical fluid [145]. To manage this feature integrated heat exchangers, flash gas bypass, multi ejector technology and parallel compression are all used which have a variety of efficiency and capacity benefits. The significance of being able to operate trans-critically is that out of all refrigerants CO<sub>2</sub> has the largest temperature lift and can simultaneously provide refrigeration and heat at above 100 °C in a single stage based on Bitzer website. Furthermore, as a heat pump it is unique as the COP is only marginally affected by the discharge temperature of the heated fluid. Fundamentally the COP is driven by the gas cooler outlet temperature which is affected by the heated fluid inlet temperature [146].

Practical limitations to high temperature heat pumping relates to the superheat requirements to achieve condensation. This superheat temperature could be too high and risk decomposition or degradation of lubricating oils. Other factors include whether solenoid valves, electronic TX valves, seals, and other instrumentation are rated at these high temperatures. All these factors need to be overcome before this technology can be offered to the market.

Mechanical vapour recompression (MVR) technology is a variant of the heat pump which can deliver the highest temperature heat from heat pumping up to 180 °C [147]. The unique characteristic of MVR is that the refrigerant is the HTF, which primarily is steam. The Australian experience through the adoption of MVRs in dairy farming has indicated that reasonably high purity water is currently required for this technology, as will be discussed in Section 5.4.7. Operating more as a blower than a compressor, the MVR system provides flow for a small pressure ratio of 1.6, whereas heat pumps typically provide a pressure ratio of 6. As a result, multi-stage MVR is typical in which around 6 stages can deliver a temperature lift of around 50 °C. Furthermore, condensate at pressure is used to de-superheat the steam after each stage, enabling for a very efficient process and preventing unwanted high discharge temperatures. Overall, simple analysis can show that COPs of both high temperature heat pumps and MVR range from 2-4 raising heat from 50 to 150 °C.

Unlike MVR heat pumps driven by mechanical energy, thermal vapour recompression (TVR) heat pumps are driven by the energy of motive steam and it is more suitable for low boiling-point rise liquids and low to medium differential temperatures to minimize the compression ratio. MVR and TVR are typically integrated in dairy evaporators [148] and distillation [149] to improve the energy efficiency and thus reducing the energy requirement. TVR heat pumps have the advantages of no rotating parts, low capital expenditure and maintenance costs [149]. They are available in all industrial sizes [150].

Table 16. List of available high temperature heat pump manufacturers.

Manufacturer	Product	Refrigerant	Heat source temperature	Max. heat sink temperature	Heating capacity	Compressor type	COP (source/sink temperature)
Kobe Steel (Kobelco steam grow heat pump)	SGH 165	R134a/R245fa	35 – 70 °C	165 °C (steam)	70 to 660 kW		1.6 – 2.5
	SGH 120	R245fa	25 – 65 °C	120 °C (steam)	70 to 370 kW	Twin screw	2.0 – 3.5
	HEM-HR90,-90A	R134a/R245fa	-10 – 40 °C (air)	90 °C (water)	70 to 230 kW		1.7 – 3.0
Vicking Heating Engines AS	HeatBooster S4	R1336mzz(Z) R245fa	60 – 100 °C	150 °C	28 to 188 kW	Piston	2.1 – 4.7
Ochsner	IWWDS R2R3b	R134a/ÖKO1	8 – 45 °C	130 °C	170 to 750 kW		4.0 (45/90)
	IWWDS ER3b	ÖKO (R245fa)	35 – 55 °C or 8 – 25 °C (two-stage)	130 °C	170 to 750 kW	Screw	2.7 (50/105)
	IWWHS ER3b	ÖKO (R245fa)		95 °C	60 to 850 kW		
Hybrid Energy	Hybrid Heat Pump	R717/R718 (NH <sub>3</sub> /H <sub>2</sub> O)	20 – 75 °C	120 °C (water)	0.25 to 2.5 MW	Piston	4.5 (40/100)
Mayekawa	Eco Sirocco	R744 (CO <sub>2</sub> )	5 – 35 °C	120 °C (air)	65 to 90 kW	Screw	2.6 – 3.6
	Eco Cute Unimo	R744 (CO <sub>2</sub> )		90 °C	45 to 110 kW		
Glacem	Heat pump	R744 (CO <sub>2</sub> )	-10 – 40 °C	120 °C (air) 90 °C (water)	100 to 1000 kW	Piston	-
Combitherm	HWW 245fa	R245fa	30 – 70 °C	120 °C	62 to 252 kW	Piston	3.4 (50/100, water)
	HWW R1234ze	R1234ze(E)		95 °C	85 to 1301 kW		
Dürr thermea	thermeo2	R744 (CO <sub>2</sub> )	8 – 40 °C	110 °C	51 to 2,200 kW	Piston (up to 6 in parallel)	3.9 (20/80)
Friotherm	Unitop 22	R1234ze(E)	12/34 °C	95 °C	0.6 to 3.6 MW	Turbo (two-stage)	3.5 (34/95)
	Unitop 50	R134a		90 °C	9 to 20 MW		
Star Refrigeration	Neatpump	R717 (NH <sub>3</sub> )	35 – 60 °C	90 °C (water)	0.35 to 15 MW	Screw (Vilter VSSH 76 bar)	3 – 5
GEA Refrigeration	GEA Grasso FX P 63 bar	R717 (NH <sub>3</sub> )	35 °C	90 °C	2 to 4.5 MW	Twin screw (63 bar)	5 (35/80)
Johnson Controls	HeatPAC HPX	R717 (NH <sub>3</sub> )	39 °C	90 °C	326 to 1,324 kW	Piston (60 bar)	4 (39/90)
	HeatPAC Screw	R717 (NH <sub>3</sub> )		90 °C	230 to 1,315 kW	Screw	
	Titan OM	R134a		90 °C	5 to 20 MW	Turbo	
Mitsubishi	ETW-L	R134a		90 °C	340 to 600 kW	Turbo (two-stage)	-
Viessmann	Vitocal 350-HT Pro	R1234ze(E)	40/50 °C	90 °C	148 to 390 kW	Piston (2–3 in parallel)	3.1 (40/90); 3.4 (50/90)

### 3.4.1.2 Heat Recovery and Heat Exchangers

A critical element of heat pumping and MVR is heat recovery from waste heat. Waste heat streams are usually exhaust from combustion processes or air/steam/hot water waste heat from processes. Extracting this heat is currently achieved through heat exchangers, which may be categorised by configuration, each with their own advantages and outstanding design challenges. The cost effectiveness of this approach relates to specific conditions of the heat source and the selection of appropriate heat exchanger.

Table 17 presents the types of heat exchangers that are currently and/or newly available. Heat exchanger development has focused on improving the specific capacity (kW per unit volume and weight) and operating range. These factors achieve both direct and indirect cost savings. Plate heat exchangers (PHE) are replacing the need for traditional shell-and-tube designs with significantly lower areas and lower manufacturing costs, reducing capital costs. Costing between \$0.01-0.02/W<sub>th</sub>, they represent a very effective solution for high temperature heat. The challenge to increase operating conditions, diffusion bonded printed circuit heat exchangers (PCHE) offer an effective solution (Figure 45). Major PCHE suppliers include Heatric, Hexces, Alfa Laval, Kelvion etc. Diffusion bonded PCHE, are

relatively more expensive ranging up to \$0.2/W<sub>th</sub> [151] today, however, with increased manufacturing volumes these types of heat exchangers are likely to be lower cost than the traditional stacked PCHE in the future. PCHE are critical for supercritical CO<sub>2</sub> systems requiring high pressures. When exposed to conditions above 600 °C, careful consideration of materials is needed as mechanical strength of austenitic steels drops rapidly after this temperature, requiring the use of nickel alloys. These alloys are horrendously expensive and should be avoided. A further issue is corrosion which is temperature dependent and can accelerate at temperatures above 600 °C. These considerations are important when attempting to recover high temperature heat for a lower temperature application.

Table 17. Summary of heat exchanger technology.

Type	Fluids	Maximum operating pressure, bar	Maximum operating temperature, °C	Materials	Example Manufacturer	Capacity Range
Shell/tube	gas / liquid / two phase flow	600	800	austenitic steels, nickel alloys	Various	All
Gasketed plate heat exchanger	gas / liquid / two phase flow	50	160	austenitic steels, nickel alloys, titanium, graphite	Alfa Laval, Sondex, Kelvion	All
Brazed plate exchanger	gas / liquid / two phase flow	70	500	austenitic steels	Alfa Laval, SWEP, Kaori	<1MW
Diffusion bonded printed circuit (PCHE)	gas / liquid / two phase flow	600	800	austenitic steels, nickel alloys	Heatrix, Hexces, Alfa Laval, Kelvion	All
Microtube	various, incl. phase-change materials	600	600	austenitic steels	Mezzo Technologies	< 1MW
Heat recovery (finned tube)	liquid/two phase flow	200	400	austenitic/carbon steels	Windsor engineering	>10 MW
Recuperator air/air	low pressure gasses	2	1000	austenitic steels	Kelvion	All
Low pressure gas finned crossflow	liquid/two phase flow	100	200	copper, aluminium	Gunther	<10 MW
Regenerators	low pressure gasses	2	1500	ceramics	Various	All

Alfa Laval Packinox, as shown in Figure 44, is the largest type of plate heat exchanger currently available in the world [152]. It is the best choice for heat recovery processes requiring high temperatures and pressures. Its high efficiency and short payback time made it the industry standard combined feed/effluent heat exchanger in catalytic reformers and paraxylene plants. The payback time is often less than a year for larger units.

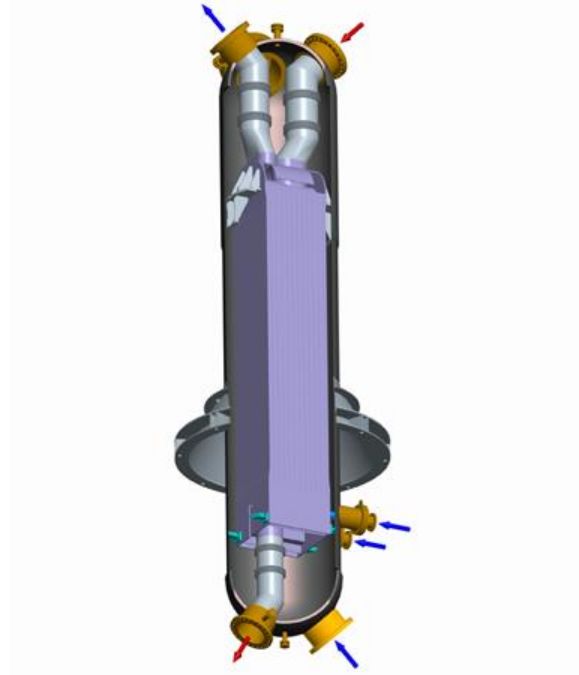

Figure 44. Alfa Laval Packinox heat exchanger [152].

Tube-in-tube heat exchangers are commonly used for fruit juice pasteurisation. This configuration allows for inspection and higher flexibility and is especially suitable for juice with fibres [153].



Figure 45. New heat exchanger technology: PCHE diffusion bonded (LHS, Alfa Laval), microtube shell/tube (RHS, Mezzo Technologies) [154, 155].

Microtube heat exchangers are a novel technology developed by Mezzo Technologies, which is able to make shell-and-tube and crossflow designs relatively cheap as shown in Figure 45. Having lower manufacturing costs than diffusion bonded PCHE, this technology offers a new opportunity for heat recovery. For both these types of heat exchangers with small passages, blockage due to fouling or corrosion products is critical to manage, affecting maintenance costs.

Traditional crossflow finned tube heat exchanger designs are ideal for delivering heat to high pressure fluids. These heat exchangers, traditionally used in the air conditioning sector, are now capable of

operating at higher temperatures and pressures, well suited for steam and supercritical CO<sub>2</sub> [156]. The operating conditions affect the material selection. Lowest cost materials such as copper tubing, carbon steel and aluminium fins are temperature and/or pressure limited, and costs increase with the need for austenitic steels. Manufacturing costs vary dramatically depending on volumes produced for specific markets. For example, heat recovery finned tube heat exchangers are sized only for large scale operations, and therefore unavailable for smaller scale of under 1 MW.

The techno-economic value of heat recovery relates to the costs associated with the heat exchanger and the efficiency gain when coupled with a heat pump. However as reflected in Figure 41, if the heat exchanger requires a large heat transfer area, fluid cleaning together with high maintenance costs, these costs may prove too prohibitive and simply be outcompeted by an increase in renewable energy generation. Generally, the estimated cost is \$0.0125/W<sub>th</sub> for a heat exchanger with a Number of Transfer Units up to 3. Brazed heat exchangers are probably the cheapest option for small-scale applications, coming in at around \$0.012/W<sub>th</sub>. However actual costs do not just relate the needed area to achieve the required pinch temperature, but also relate to other integration costs. Ultimately correct heat exchange sizing and selection is a non-trivial exercise to achieve a cost-effective solution.

Regenerators are a novel, but traditional, heat exchanger which uses a ceramic to temporarily store heat from exhaust gasses, to be later used to heat cooler gases. Cycle times range from seconds to an hour. The system can either be stationary or designed as a rotating wheel. Well suited for furnaces which require continuous fresh air as a reactant, this form of heat recovery, has built in thermal energy storage. It is may be possible to expand the feature of this technology, which could integrate well with renewable energy generation [157].

An expansion of this concept is the mobile heat storage system which has been demonstrated in Germany and is shown in Figure 46. A thermochemical type of storage it has a high energy storage density and is used to absorb waste heat at one location, and then transported to another location where this heat is used, delivering 60 °C dry air[158].



Figure 46. Mobile TES from waste heat source [158].

### 3.4.1.3 Electric Heating

With renewable electricity achieving very low costs, the opportunity exists for direct electric heating. It is well established that direct electric heating can be up to three-times more efficient in cooking

## Electrification & Renewables to Displace Fossil Fuel Process Heating

processes due to the targeted nature of applying electric heat. Other electric driven technologies are now available which enhance this capability.

Direct electric heating can include electrode driven boilers for steam production, and electric steam/air ovens for drying/cooking/curing processes are a common technology [159]. Furthermore, electric systems can be compact and relatively easy to integrate into existing systems. With capital costs less than \$0.02/Wth, these technologies can be a financially attractive option to absorb excess solar PV production.

Microwaves (MW), infrared (IR), and radio frequency (RF) technologies are available from a variety of companies, for different industrial food processes. Equipment is made for either batch or continuous drying, assisted freeze drying, sterilization, and pasteurization. Typically, microwaves and RF are used for direct heating of food whereas IR can be used to for direct heating of food as well as space heating [160]. Table 18 below shows a list of commercially available systems. Figure 47 shows the size of these systems.

Table 18. Microwave, infrared and radio frequency heating systems available on market.

Company	Heating Type	Cont. or Batch	Power Output	Channel Dimension /Capacity	Power Factor	Model Name	Reference
<b>Ferrite</b>	Microwave	Cont.	75 kW	1.3 x 3.7 x 0.9 m <sup>3</sup>	0.9	MIP11	<a href="https://ferriteinc.com/wp-content/uploads/2018/04/MIP11.pdf">https://ferriteinc.com/wp-content/uploads/2018/04/MIP11.pdf</a>
<b>Pueschner</b>	Microwave	Cont.	1.2-24 kW	1.2 x 2.2 x (0.8-1.6) m <sup>3</sup>	NA	μWaveDry erxx05	<a href="https://saltxtechnology.com/">https://saltxtechnology.com/</a>
<b>Ferrite</b>	Microwave	Batch	75 kW	0.9 x 1.3 x 1.3 m <sup>3</sup>	0.9	MIP 4	<a href="https://ferriteinc.com/wp-content/uploads/2018/04/MIP4.pdf">https://ferriteinc.com/wp-content/uploads/2018/04/MIP4.pdf</a>
<b>Kreyenborg</b>	Infrared	Cont.	NA	NA	NA	FoodSafety-IRD	<a href="https://www.kreyenborg.com/en/product/foodsafety-ird/">https://www.kreyenborg.com/en/product/foodsafety-ird/</a>
<b>Tansun</b>	Infrared Space Heater	Cont.	12 kW	50.7 sqm work zone	1	A3L 120	<a href="https://www.tansun.com/gb_en/infrared-heaters/apollo/apollo-a3l2.html">https://www.tansun.com/gb_en/infrared-heaters/apollo/apollo-a3l2.html</a>
<b>Stalam</b>	Radio Frequency	Cont.	85 kW	800 kg/ hr @ 80 °C	NA	SANIFLUID +	<a href="https://www.stalam.com/en/g/product/food/pasteurisation-and-sterilisation/pasteurisers-for-liquid-products-in-the-tube-sanifluid">https://www.stalam.com/en/g/product/food/pasteurisation-and-sterilisation/pasteurisers-for-liquid-products-in-the-tube-sanifluid</a>
<b>Miele</b>	Radio Frequency	Batch	2.4 kW	Domestic Oven	NA	Dialog Oven	<a href="https://www.miele.com/brand/en/revolutionary-excellence-38683.htm">https://www.miele.com/brand/en/revolutionary-excellence-38683.htm</a>

A review on the Pueschner website indicates overall efficiency, from mains to power dissipated in the product, of microwave heating to be 50-70%. For gas IR heating, efficiency is between 30-50% whereas electric IR heating efficiency is 40-70% [161]. Radio frequency heating efficiency range is 50-60% [161].

Ohmic heating, also known as Joule heating, occurs when an electric current flows through a medium and has an efficiency of 99% [161]. Induction heating is also a method of converting electricity to heat

with an efficiency of 98% [162]. Because material and geometry effects of these last two technologies are not well understood from a large-scale point of view not many variable commercial systems are available [162].

These heating methods will be discussed in further detail in the lower technology readiness section.

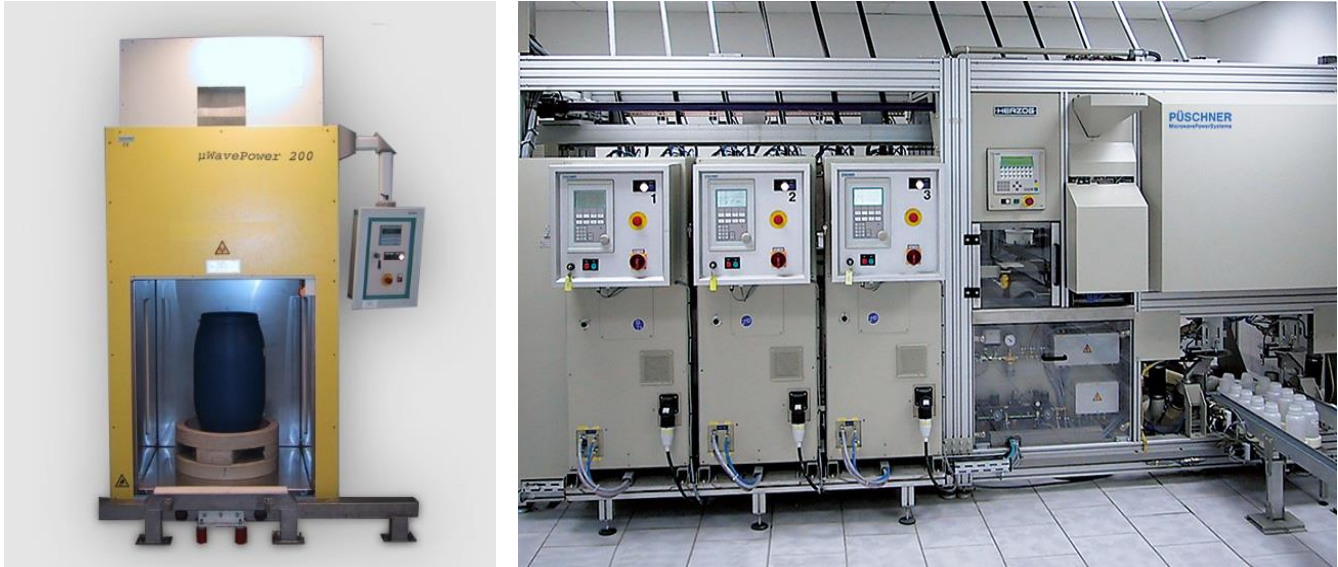

Figure 47. Small batch microwave oven from Pueschner (LHS)  
Continuous microwave system from Pueschner (RHS) [163, 164].

### 3.4.2 Solar Thermal and Other Renewable Energy Technologies

An overview of solar thermal technologies at the high TRL is provided. A brief overview of other renewable energy options is provided, a more detailed investigation being beyond the scope of this review.

#### 3.4.2.1 Solar Thermal and Concentrated Solar Thermal

All solar thermal technology (solar thermal, ST and concentrated solar thermal, CST) fundamentally aims to achieve sufficient efficiency at minimum cost, in order to minimise the \$/Wth. The efficient delivery of heat up to 150-250 °C cannot be achieved by conventional flat plate solar thermal collectors and therefore requires higher efficiency evacuated tube systems or concentrating systems.

Recent developments of evacuated tube collectors has achieved efficiencies of over 60% for the delivery of steam over 200 °C [165], delivering \$/Wth less than \$0.5/Wth, consistent with flat plate collectors in the provision of hot water. The National Renewable Energy Laboratory (NREL) in the United States provides a review of solar industrial process heat in the US, showing how growth in this technology can replicate that of flat plate collectors [166]. An advantage of ground mounted evacuated tube collectors is they are likely to deliver a lower footprint than an equivalent solar PV system.

Concentrating solar thermal delivering temperatures below 250 °C include trough and linear Fresnel systems, have been technically well established, and can deliver efficiencies above 80%. Reduced costs through the development of proper supply chains, suggest these technologies can be competitive. NREL showed costs now range from 4-6 USD/GJ, which in the Australian context can be very competitive.

A fundamental disadvantage of CST is the reliance on direct irradiance, and avoidance of cyclone prone areas, and therefore very location dependant. This is not applicable to ST, making ST readily applicable

to all regions without the need for detailed investigation. Examples of CST and ST technologies can be seen below in Table 19

Table 19 Concentrated and Non-Concentrated Solar Thermal Energy Systems

Technology	Example Manufacturers	Temperature
Evacuated Tube	Greenland Systems	200 °C
Parabolic Trough	NEP Solar	230 °C
Fresnel	Industrial Solar	400 °C

#### 3.4.2.2 Heat from Biomass/Biogas or Waste

Direct burning of biomass or biogas is the traditional form of renewable heat. Biogas is formed from biodigestion or gasification of animal/food waste, whereas biomass burning represents direct combustion of dried fibrous/cellulotic agricultural material. Burning of waste such as municipal waste can also be used for heat production. These options have unique challenges including, generating/sourcing enough supply/feed stock, variation in feed stock quality and composition, and environmental regulation concerning combustion emissions. In the case of biomaterials, these issues need to be contrasted with other pathways of these feed stocks [167]. With regards burning of waste streams, consideration of other waste management techniques and environmental impacts is required.

The application of generating heat using a biogas boiler needs to be contrasted with the value the biogas offers as a green fuel. This factor is particularly relevant if biogas production and heating needs are mismatched. Therefore, where gas grid injection is available, burning of biogas as a source of heat should be contrasted with the value proposition offered by gas grid injection.

The pelletising of biomass has become attractive option and does offer some standardisation of quality but increases cost. The conversion of biomass to biomethane through gasification processes, or diesel or jet fuel from Fischer-Tropp processes, has also attracted significant attention [168]. Overall, this shows that the use of biomass or biogas at volume for heat production, needs to be contrasted with the higher value these products can offer as a green fuel. However, the costs of local production, processing and transport may make this latter option redundant.

#### 3.4.2.3 Power Generation from Renewable Heat

Concentrated Solar Power (CSP) is a variation on CST capable of delivery of both heat and power. CSP and renewable gas combined heating and power plants (CHP) represent renewable energy heat delivery technologies which produce both heat and power. The characteristic of these technologies is they produce electricity from heat, through engines or turbines. The \$/We of these technologies are not decreasing and this needs to be contrasted against the CAPEX reduction of solar PV and wind power over time. As a result, in a renewable energy driven electricity grid, often CHP and CSP cannot deliver bulk electricity competitively relative to solar PV and wind, particularly with the onset of new off-peak daytime tariffs, and this therefore reduces the value proposition of these technologies. It can therefore be argued that these technologies are lending themselves to offering peaking services as stated by an Australian Solar Thermal Research Institute (ASTRI) report, in the case of CSP [169].

The opportunity cost of not selling green derived gas represents a legitimate factor in evaluating the techno-economic value of a CHP. It has been shown that using HP together with solar PV can be more competitive than a CHP plant if the biogas can be sold [170], and this trend is likely to increase. If the



heat generated cannot be used productively during power generation, the value proposition of this technology further diminishes.

Although it is difficult to generalise the value proposition of these technologies, they can readily offer a value proposition for a specific C&I application once a detailed techno-economic study has been conducted.

### *3.4.3 Energy storage*

Energy storage is a critical component to the electrification of heat with renewable energy. This can be achieved with both battery and thermal energy storage. Steam accumulators are commonly used in the conventional process industry. Pressurized liquid water at the boiling temperature is stored and steam is generated by lowering the pressure of the saturated water during discharge. They have been installed in some commercial solar plants for short period storage with less than 1 h [171]. Over the past few decades significant development has occurred regarding high temperature thermal energy storage (TES). Table 20 presents some of the high-TRL technologies available globally for thermal energy storage systems which are charged electrically and can deliver heat [172]. Other thermal energy storage systems do exist however this list only presents those which can be used to supply heat at temperatures up to 200 °C, which will be invariably lower than the storage temperature. These technologies have been developed focusing on minimising the capital cost defined by  $\$/\text{kWh}_{\text{th}}$ . In this process, this is achieved by using low cost storage materials such as rocks, or high energy density storage materials such as thermochemical or latent energy systems. Furthermore, the systems primarily deliver heated air or water/steam which can be integrated into downstream processes. This requires specific system configurations, with low pressure air suited to a packed bed design and coil-in-tank arrangement suited for high pressure water/steam systems.

To minimise the storage capital cost, a high storage temperature is attempted, which is particularly relevant to sensible storage materials. However, this will result in increased costs to overcome mechanical strength and corrosion issues. As explained by [151] these factors together with integration costs can significantly vary the cost of TES. Therefore, selecting a suitable TES which complements the process is critical to minimising integration costs and achieving a genuine low capital cost.

Referring to Table 20, Energy-Nest is a scalable concrete based technology, as presented in Figure 48 and is available in Australia. SaltX and Teamsolid offer a unique thermochemical storage solution of very high energy storage density. Consequently, this technology could represent a seasonal storage solution and compete with a green fuel driven solution.

## Electrification & Renewables to Displace Fossil Fuel Process Heating

Table 20. Summary of high TRL thermal energy storage technology global developments.

Company (website)	System Config	Storage Type	Storage Medium	Heat Transfer Fluid	Storage Temperature, °C	Scalability
<b>Siemens</b> (www.siemensgamesa.com)	Packed Bed	Sensible	Volcanic rock	Air	>600	Large scale
<b>Storasol</b> (storasol.com/technik)	Packed Bed	Sensible	Rocks	Air	>600	Modular
<b>Kraftblock</b> (kraftblock.com)	Coil-in-tank/Packed Bed	Sensible	Waste-based ceramic	Air	>500	Modular
<b>Pebble Heater</b> (pebble-heater.com)	Packed Bed	Sensible	Rocks	Air	>500	Large scale
<b>Alumina Energy</b> (www.aluminaenergy.com)	Packed Bed	Sensible	Alumina	Air	200-1500	Modular
<b>Lumenion</b> (lumenion.com)	Packed Bed	Sensible	Steel	Steam	>600	Large scale
<b>Brenmiller Energy</b> (www.bren-energy.com)	Coil-in-tank	Sensible	Crushed Rock	Water/steam	500	Modular
<b>Energy Nest</b> (energy-nest.com)	Coil-in-tank	Sensible	Heatcrete	Water/steam	550	Modular
<b>Graphite Energy</b> (www.graphiteenergy.com)	Coil-in-tank	Sensible	Graphite	Water/steam	>500	Modular
<b>Malta</b> (www.maltainc.com)	2-tank	Sensible	Molten salt	Molten salt	565	Large scale
<b>MGA</b> (www.mgathermal.com)	Coil-in-tank	Latent	PCM composite	Water/steam	>575	Modular
<b>Team Solid</b> (teamsolid.org)	Iron Powder Reactor	Thermochemical	iron oxide	Air	1800	Modular
<b>SaltX</b> (saltxtechnology.com)	Reactor	Thermochemical	CaO+Steam	Water	450-600	Large scale



Figure 48. Modular TES technology from Energy-Nest [173].

The techno-economics of energy storage relates to the COP or effectiveness of the electric-thermal conversion of the heat delivery device. Fundamentally the higher this conversion effectiveness the lower the value proposition of thermal storage, relative to electric storage. Table 21 presents this concept for various costs of TES comparing a TES which stores the thermal energy produced by a heat pump compared to an electric battery which stores the energy electrically to drive the heat pump. In

the literature the cost of TES has been stated as below \$50/kWh<sub>th</sub> [151]. However, these costs are usually based on mass scale and are used for comparative basis. As shown in Table 21, if the actual installed costs were much higher it shows that when compared to a battery with a nominal installed cost of around \$700/kWh<sub>e</sub>, depending on the COP, a battery system could be more cost effective.

This consideration is also a factor for different heat delivery systems. Novel electrical heating systems such as induction heaters which can deliver the same heat with less losses than a conventional convection processes, will make a battery driven energy storage option more cost effective than a thermal energy storage driven process.

A further consideration is the amount of storage needed. The trend for TES in CSP plants is for longer hours of storage, however the initial hours deliver the highest financial return. Industrial heat processes with steam may only need a few hours storage, in which case the conventional steam accumulator could be sufficient. Being unable to provide more than a few hours economically, an electrically charged steam accumulator could represent an excellent storage solution for many processes [174].

Table 21. Comparison of thermal and battery energy storage cost with the impact of COP.

TES Cost, \$/kWh <sub>th</sub>	COP	Electric Equivalent Cost, \$/kWh <sub>e</sub>
50	1.5	75
100		150
200		300
50	3	150
100		300
200		600
50	5	250
100		500
200		1000

Finally, energy storage has a significant value in providing reliable heat. For example, from industry discussions, in many food processing facilities which use aseptic techniques a loss of power can result in a 100% loss of daily production. Thermal and battery energy storage can potentially provide backup heat and avoid this costly outcome.

### 3.5 Mid-TRL Technologies

This section provides a review on heat pumps, direct heating, and thermal energy storage technologies rated at TRL of 5-7. These levels range from laboratory testing of integrated/semi-integrated system to pilot plant demonstrated technologies.

#### 3.5.1 Energy efficiency

##### 3.5.1.1 Heat pumps

Most commercialized high-temperature heat pump systems can generate heat up to approximately 90 °C. To achieve higher heat delivery temperature, research and development (R&D) has focused on the investigation of suitable refrigerants, compressors, and possible thermodynamic cycles.

The DryFiciency project focused on improving energy efficiency and reducing CO<sub>2</sub> emissions by using high-temperature heat pumps for waste heat recovery. DryFiciency has designed, built, tested and demonstrated two heat pump technologies in three industrial plants, which require either air or steam in drying processes at up to 160 °C [175].

Targeting the low-temperature heat source (e.g. 20-65 °C), Johnson Controls constructed a heat pump using an economizer circuit with internal heat exchanger and R-245fa was applied as the refrigerant. Both two-screw compressor and centrifugal compressor with magnetic bearing were developed and tested to cover the heating capacity range of 900 – 1200 kW. The COP reaches 5-6 at 60 °C source and 100 °C sink temperatures and 120 °C sink temperature is feasible [127, 150]. This technology is in the stage of pre-commercialization and a picture of the manufactured heat pump is shown in Figure 49.



*Figure 49. Picture of the Johnson Controls /EDF heat pump [150].*

In a pilot plant demonstration, Chamoun et al. [176] tested a heat pump up to 145 °C using a twin-screw compressor of 90 kW and water as the refrigerant. Waste heat at a temperature of 85-95 °C provides the heat source for this vapour compression cycle. Both condenser and evaporator are stainless steel gasketed plate heat exchangers. The system achieved a COP of around 5.5 at a sink temperature of 121 °C. Based on the economic evaluation, the payback period is expected to be less than 2 years by replacing a furnace with this heat pump.

A heat pump operating with pentane (R601) successfully generated low-temperature steam of 130 °C using 90 °C waste heat. A variable-capacity screw compressor was used with a motor power of 75 kW and this system achieved a COP of 4.5 at 80 °C source and 135 °C sink temperatures [127].

In the framework of ALTERECO, a new blend refrigerant (ECO3™), which is non-toxic, non-flammable and environmentally safe, was developed. A prototype was built with two parallel scroll compressors of 75 kW each, an internal heat exchanger and a sub-cooler. The performance mapping and endurance tests were conducted. It was demonstrated under industry-like environment that this heat pump reliably provides heat, efficiently, up to 125 °C and it is feasible to use it up to 140 °C [177].

### 3.5.1.2 Direct heating

One of the draw backs with MW, IR, and RF heating is that the target material should be relatively homogeneous or repeating in some way. Inhomogeneous materials will have portions that are over or under heated, resulting in material degradation in some cases. For this reason, technology provided by Goji Food Solution has demonstrated a method for sensing and changing RF, resulting in uniform heating of inhomogeneous materials [178]. It can be adapted to different shapes and sizes but does require calibration.

Another method for direct heating is using a silicon carbide target with a microwave as seen in Figure 50. The high melting point of silicon carbide (2700 °C), low coefficient of expansion, and molecular polarity make it a practical heating element/target for microwave heating. Work done by Serio et al. [179] showed the viability of using silicon carbide in a microwave chamber as a pyrolyzer for solid wastes. The target material reached nearly 1000 °C in less than 10 mins. The formation of hydrogen from waste sludge also occurred in appreciable amounts [179]. The microwave conversion efficiency was 65%.

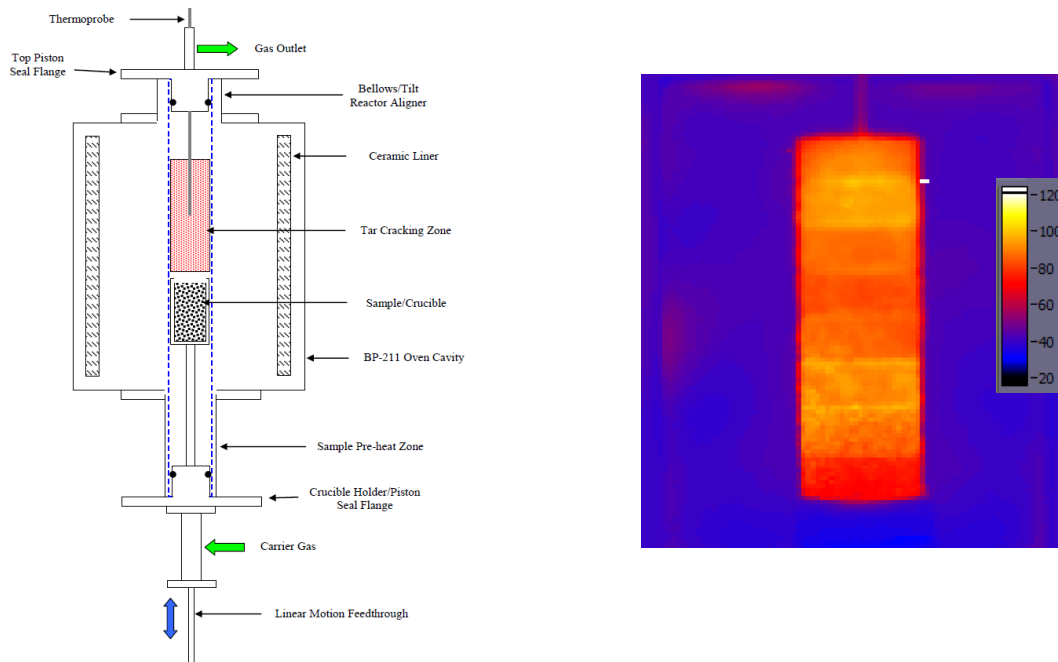

Figure 50. Schematic and thermal image of the silicon carbide pyrolyzer by Serio et al [179].

### 3.5.2 Solar Thermal Technologies

The recent improvement in the thermal performance of evacuated tube collectors can be categorised into: structural modification, applying coatings to improve solar absorptivity, integrating with reflectors, heat pipes or thermal energy storage, and developing advanced working fluids [180]. Wang et al. [181] built and tested an evacuated tube air heaters with simplified compound parabolic concentrator (CPC) and concentric tube heat exchanger as shown in Figure 51. Its thermal efficiency is 0.35 at an air outlet temperature of 150 °C and it drops to 0.21 at the temperature of 220 °C.



Figure 51 Photograph of the evacuated tube air heater [181]

A solar air collector with simplified CPC and open thermosyphon using water based CuO nanofluid as the working fluid was tested under outdoor conditions [182]. Unlike common evacuated tube collectors, this open thermosyphon structure enables the improvement of heat transfer performance with the increase of operating temperature (below a turning point of temperature). For the prototype under test, the maximum collecting efficiency can reach 0.56 when the air outlet temperature is 130 °C. The efficiency drops to 0.46 when the air outlet temperature is 160 °C. The collector integrated with open thermosyphon is 12.74% more efficient than that with concentric tube.

It is economically viable to use evacuated tube solar air collector in food drying process, which has demonstrated in drying fenugreek leaves and turmeric [183] and garlic clove [184]. So far, the demonstration and application are limited to small scale industries.

To match the availability of solar energy to the energy demand, thermal energy storage system can be coupled with solar thermal collectors to store the excess thermal energy and release it to meet the load when required. Latent thermal energy storage using phase change material (PCM) offers the advantage of reducing the fluctuation of output temperature and therefore drew extensive attention. It was reported that the PCM integrated evacuated tube solar collectors are more effective and stable in terms of delivering energy [185]. The efficiency can be improved by 32-37% [186]. Demonstration this technology in real conditions and applications is a necessity before commercialisation.

### 3.5.3 Energy storage

The mid-TRL thermal energy storage technologies were reviewed and summarised in Table 22. Latent thermal energy storage has attracted extensive attention from both industries and research institutions. This technology is at the stage of laboratory prototype testing and pilot demonstration. The PCMs are mainly metals (e.g. silicon) and inorganic salts. Thermochemical storage mainly uses oxide/hydroxide reversible reactions, metal/metal hydride reactions, oxide/carbonate reactions and redox reactions above 100 C [187].

Two South Australian companies, CCT Energy Storage and 1414 Degrees, have commercialized the latent thermal energy storage, which melts metallic silicon and stores heat. CCT Energy's storage device, shown in Figure 52, can adopt any form of electricity input and turn it back into electricity on demand [188]. As a bi-product, hot water of 78 °C is supplied. CCT Energy is going to pilot the storage device in the telecommunication and eco-housing industries. In addition to electricity input, 1414

## Electrification & Renewables to Displace Fossil Fuel Process Heating

Degrees' storage device can store energy generated from biogases and has been installed and operated at SA Water's Glenelg Wastewater Treatment Plant in Adelaide (shown in Figure 53).

*Table 22. Summary of mid-TRL thermal energy storage technology global developments.*

Institution	System Configuration	Storage Type	Storage Medium	Heat Transfer Fluid	Storage Temperature, °C	Deliverables	Scalability	Ref.
<b>CCT Energy Storage</b>	-	Latent	Silicon	Water	1414	Water /electricity	Small-large	[188]
<b>1414 Degrees</b>	-	Latent	Silicon	Air	1414	Water, steam, air, oil /electricity	Large scale (10-1000 MWh)	[189]
<b>German Aerospace Centre (DLR)</b>	Coil-in-tank	Latent-sensible	Sodium nitrate-concrete	Water/steam	306	Direct steam generation	Small-large	[190]
<b>DLR</b>	Shell-and-tube	Cascade latent	Alkali nitrate salts	Synthetic oil	306 – 335	Oil	Small-large	[191]
<b>Xi'an Jiaotong University</b>	Shell-and-tube	Cascade latent	Carbonate salts	Air	420-500	Air	Small-large	[192]
<b>Fraunhofer ISE</b>	Screw heat exchanger	Dynamic latent	Alkali nitrate salts	Water/steam	221	Steam	Small-large	[193, 194]
<b>UniSA</b>	Coil-in-tank	Latent	Sodium carbonate-sodium chloride	Air	638	Air	Small-large	[195]
	Coil-in-tank	Dynamic latent	Sodium nitrate	Air	306	Air	Small-large	
<b>University of Lleida</b>	Coil-in-tank	Latent	Hydroquinone,	Synthetic oil	173	Oil/air	Small-large	[196]
			D-Mannitol	Synthetic oil	167	Oil/air		
			sodium nitrate	Silicone fluid	301	Silicon fluid/air		
<b>Highview Power Storage</b>	Tank	Latent	Liquid air	Liquid air	< -196	Electricity	5-100+ MW	[197]
<b>ZAE Bayern</b>	Reactor	Thermochemical	Zeolite	Air	>130	Air @ 60	Modular	[158]
<b>DLR</b>	Reactor	Thermochemical	Calcium hydroxide	Air	300 – 550	Air	Modular	[198, 199]
<b>Shanghai Jiao Tong University</b>	Reactor	Thermochemical	Calcium hydroxide	Steam	Up to 650	Steam	Modular	[200]



Figure 52. CCT Energy Storage's thermal battery [188].



Figure 53. 1414 Degrees' biogas thermal energy storage system [201].

The Fraunhofer Institute for Solar Energy Systems (ISE) invented and developed a dynamic latent heat storage system and a laboratory-scale prototype was tested [193, 194]. This innovative storage system consists of two tanks (containing liquid PCM and solid PCM), the screw heat exchanger (SHE, where phase change takes place), conveyor screws and pumps for liquid PCM. In charging, the solid PCM is transported from the solid PCM storage tank to the SHE and melted by the hot steam. The steam is condensed and pumped back to the steam generator. The molten PCM is pumped and stored in the liquid PCM tank. The steam could be from waste heat or concentrate solar thermal collector. In discharging, water is evaporated in the SHE and steam is generated. The solidified PCM is transported back to the solid PCM tank. The experiment was conducted, and it demonstrated the success charging and discharging with water/steam. The prototype is presented in Figure 54.





Figure 54. Overview of the storage test facility with screw heat exchanger with two shafts in front, two transport screws, and the tank for solid PCM in the back [194].

A prototype storage unit containing a high-temperature PCM were constructed and tested in a test facility at the University of South Australia as shown in Figure 14. In discharging, the air was exhausted at a temperature of about 220 °C – 320 °C until the phase change completed [195]. Agitating PCM was proven to be effective to enhance the heat transfer in low-temperature application. The University of South Australia successfully demonstrated this concept by testing a high-temperature storage unit with an auger installed at the centre of the storage unit.



Figure 55. Left: High-temperature test facility; Right: auger melting rig at the University of South Australia [195].

The University of Lleida built a pilot plant experimental test facility as presented in Figure 56, which allows testing performance of thermal energy storage systems between 45 °C and 400 °C. Three storage tanks with shell-and-tube configuration were constructed, each containing up to 0.17 cubic metres of storage materials. Latent storage systems with hydroquinone, D-Mannitol and sodium nitrate were tested, respectively. This system is very promising to supply hot air with an installed air-HTF heat exchanger.

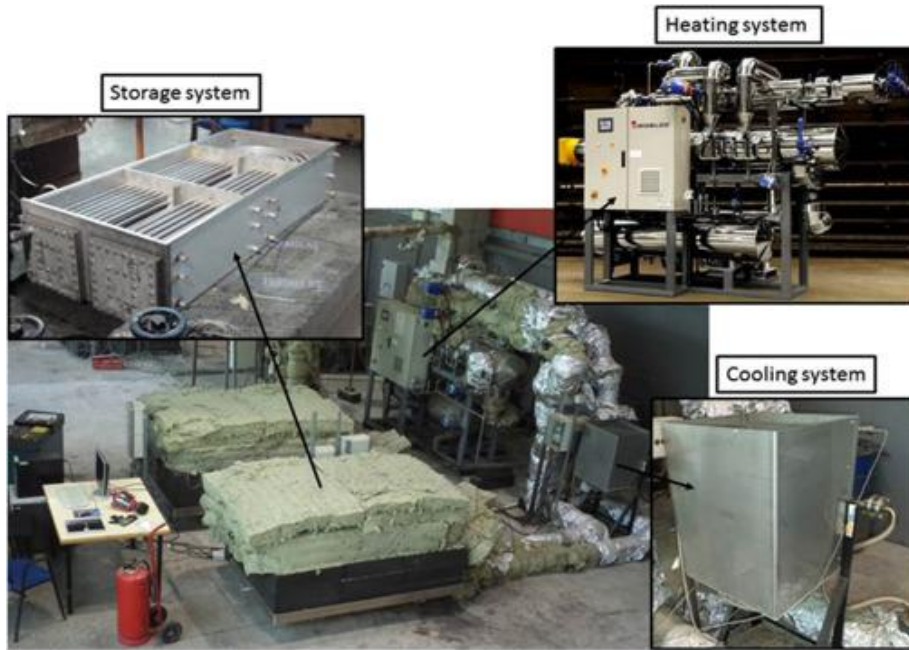

Figure 56 Pilot plant experimental facility built at the University of Lleida [196]

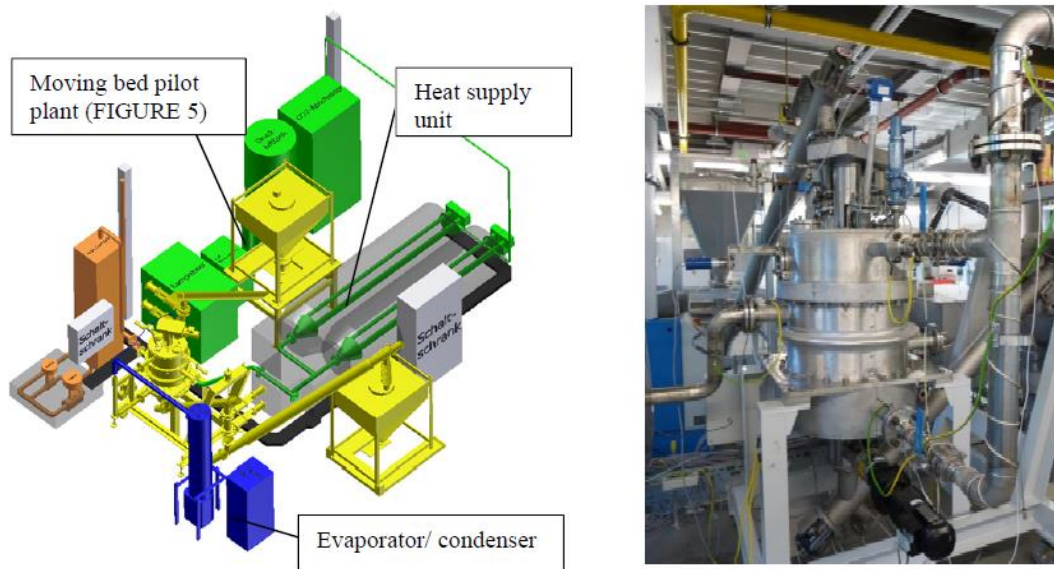

Figure 57. Integration scheme of the moving bed pilot plant into DLR's thermochemical test bench [199].

Highview Power Energy has developed and commercialized a cryogenic energy storage technology using liquified air as a storage medium [197]. This technology provides a long-term storage solution like hydrogen and pumped hydro. The stored liquified air was primarily used to generate electricity with a high efficiency of 60% in standalone and 70% by integrating waste heat or cold. However, it hasn't been demonstrated to directly produce heat. Thermochemical storage containing 14 tonnes of zeolite was employed in a mobile sorption heat storage system, which transported the industrial waste heat and used it in a PVC sludge drying plant [158]. Zeolite storage provides a very high energy density of 200 – 308 kWh/t at 135 – 250 °C. Based on an economic analysis, the heat production price

of round about €50/MWh is achievable [202]. German Aerospace Centre has built a moving bed pilot plant and the test will be conducted in an existing thermochemical test bench [199].

### 3.6 Low-TRL Technologies

The technologies are still in the early stage of research (TRL  $\leq$  4) are presented in this section.

#### 3.6.1 Energy Efficiency

##### 3.6.1.1 Heat pumps

Thermo acoustic heat pump upgrades heat from a low-temperature level to a higher temperature level by the acoustic power. Employing the noble gas (without phase change) as a working fluid in a Stirling-like cycle, the thermo acoustic heat pump could use relatively simple components containing no moving parts. This offers the easy practical implementation and economic benefit [150]. This technology is in the stage of prototype development and laboratory testing. Energy Research Centre of the Netherlands has tested a bench-scale thermo acoustic heat pump, delivering the heat of 4 kW at a temperature of 105°C, and found a COP of 2.6 [203].

A lab-scale thermochemical heat transformer prototype was constructed and the working pairs of  $\text{MnCl}_2/\text{NH}_3$ - $\text{SrCl}_2/\text{NH}_3$  were used to verify the feasibility of the technology [204]. This technology is very suitable to convert, and store, the medium/high-grade heat obtained from intermittent renewable energy or industry waste heat into the continuous low-grade heat for space heating, hot water supply, and industrial processes [204]. Various working pairs for thermochemical heat transfer to be able to supply heat at 150 °C were reviewed in a journal article from the University of Lyon in France[205].

By using standard components and a low GWP refrigerant, (HT 125), Swiss scientists developed a laboratory heat pump and achieved a COP of 4.5 when delivering heat at 120 °C from a source temperature of 80 °C [127]. This heat pump can operate up to 140 °C from 60 °C to 90 °C source temperature. Similar performance was achieved by Reißner et al. [206] by using an IHX and an electric heating band and a refrigerant of LG6.

##### 3.6.1.2 Direct heating

Temperature can be viewed as the collective vibrations of a control volume of atoms or molecules. Electromagnetic heating is characterized by its ability to generate heat by polarizing the guidance of polar diodes such as water or forced movement of ions [207]. For this reason, electromagnetic (EM) processes are an attractive candidate for turning electricity into heat. The list of known EM forms of heating use microwaves, infrared, radiofrequency, ohmic, and magnetic induction. Each of these forms have positive and negative aspects ranging from efficiency, penetration depth, and cost.

The most common of EM heating is microwave heating. Microwave heating of foods results from conversion of electromagnetic energy to thermal energy through increased agitation of water molecules and charged ions when exposed to microwaves [208]. Heat generation using microwaves can be not only standalone but also work with other technologies. Similarly, microwaves cause heating from the inside out.

Infrared (IR) heating is like microwave heating. The absorption of IR waves generates heat. The major difference is that IR waves are closer to visible light than microwaves. Also, IR radiation causes heating from the outside in [161]. Radio frequency (RF) is like IR and microwave heating. The vibration of water molecules generates heat. The major difference of RF to IR and microwaves is penetration depth.

Other low TRL forms of direct heating include ohmic (joule) heating and magnetic induction. Both methods have an efficiency close to 100% [161, 162]. The major hurdles of these technologies is uniformity i.e. uneven heating of heterogeneous materials.

3.6.1.3 *Intrinsic caloric materials*

New materials are being made that change temperature based on external forces. This includes magnetocaloric [209], electrocaloric [210], and elastocaloric [211]. Applied magnetic field, electric field, or mechanical load on a material will result in a temperature change. Theoretical and lab scale systems have been produced that use these intrinsic effects. Figure 58 below are one such schematic.

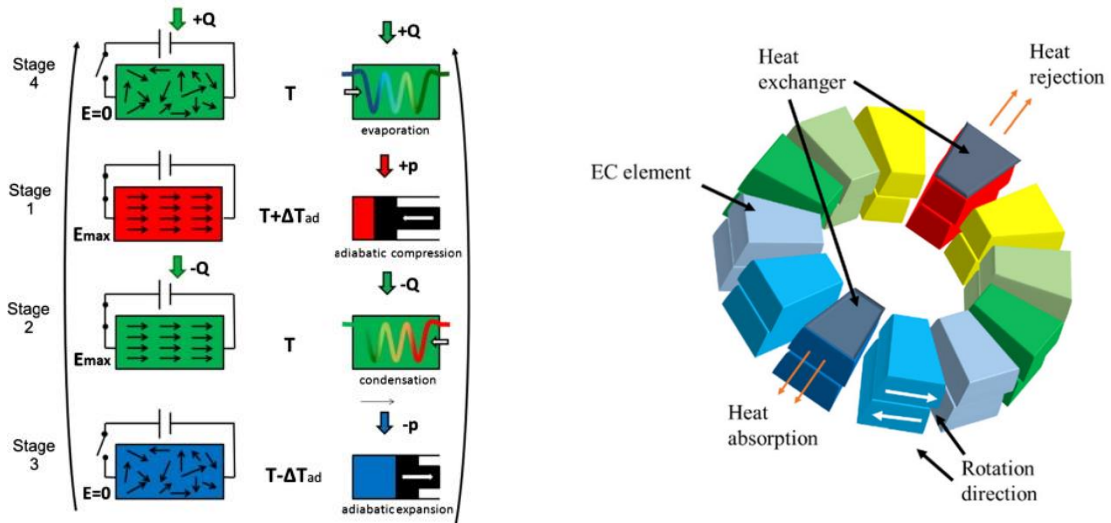

Figure 58. Shows an electrocaloric system. An applied electric field is applied causing an increase in temperature [210].

The major benefit from these systems is that there are little to no moving parts which greatly reduces maintenance. Inversely, some of these materials can be exotic and not abundant. Nitinol, the shape memory nickel titanium alloy, is used in surgical theatres making it more readily available. This same material has been employed in a lab scale elastocaloric system, showing its viability as a solid-state refrigerant. Table 23 below shows a comparison of these cooling technologies with traditional liquid vapour systems. Like all systems, many parts can be substituted or replaced. Advances in technology will usher in new heat pumps, storage systems, and power generators. These will affect overall performance and cost.

Table 23. Comparison of cooling technologies.

Technology	COP/COP <sub>Carnot</sub>	Environmental impact	Cost
Vapour compression	Up to 60%	High	Low
Magnetocaloric	Up to 70%	Low	High
Electrocaloric	Up to 50%	Low	Medium-High
Elastocaloric	Up to 83%	Low	Low

3.7 *Conclusions*

The electrification of heat with renewable electricity can offer a low-cost solution for the decarbonisation of the heat sector up to 250 °C. Hybrid system designs are critical to achieving economic Levelised Cost of Heat. This can be achieved using renewable electricity to drive energy efficient processes through energy storage while using green fuels to meet the residual short fall. In

the short term for high-TRL technologies, heat pumps and MVRs solutions with thermal energy storage solutions are available as effective energy efficiency measures. Mid-TRL solutions offer a similar outcome with innovations related to overcoming cost, range, and efficiency barriers. However, longer term low-TRL solutions can potentially fully electrify processes and make electric battery the storage technology of choice. Overall, what is clear from the technology review is that there are a plethora of options and only tailored integration studies specific to each industry can identify suitable technology configuration options. Furthermore, these options will change with time depending on the development of new technologies.

Temperatures slightly above the target temperature range are also included if it is part of an overall process flow where most of the heat is supplied <150 °C. Additionally, where heat transfer fluid (HTF) temperatures are available in lieu of process temperatures, the analysis includes processes with HTF temperatures ≤200 °C-250 °C because HTF temperatures generally exceed process temperatures.

Table 24. Summary of technologies investigated

	High-TRL Technologies	Mid-TRL Technologies	Low-TRL Technologies
<b>High-temperature heat pumps</b>	<ul style="list-style-type: none"> <li>• Vapour compression, mechanical and thermal vapour recompression, hybrid absorption-mechanical compression. <ul style="list-style-type: none"> <li>• Piston/screw compressors.</li> <li>• Refrigerants: HFCs, HFOs, R717 and R744.</li> <li>• HFC system: source temperature of subzero-70 °C; sink temperature up to 130 °C; capacity of 10s kW-10s MW; COP of 2-4.</li> <li>• HFO system: source temperature of 10-50 °C; sink temperature up to 95 °C; capacity of 10s kW-1s MW; COP of 3-3.5.</li> <li>• CO<sub>2</sub> system: source temperature of 5-40 °C; sink temperature up to 120 °C; capacity of 10s kW-1s MW; COP of 2-4.</li> <li>• NH<sub>3</sub> system: source temperature of 30-40 °C; sink temperature of 90 °C; capacity of 100s W-10s MW; COP of 3-5.</li> <li>• Hybrid system: source temperature of 20-75 °C; sink temperature of 120 °C; capacity of 100s kW-1s MW; COP of 2.4-4.5.</li> </ul> </li> <li>• €300-800/kW</li> </ul>	<ul style="list-style-type: none"> <li>• Two-screw, Rotrex, centrifugal &amp; scroll compressors, economizer circuit with internal heat exchanger, subcooler.</li> <li>• Refrigerants: R600, R601, R704, R718, ECO3™.</li> <li>• Higher COP up to 6.</li> <li>• sink temperature up to 140 °C.</li> </ul>	<ul style="list-style-type: none"> <li>• Refrigerants: HT 125, LG6 &amp; noble gases.</li> <li>• Thermo acoustic: noble gas as the working fluid in a Stirling cycle; no moving parts, easy implementation and low-cost.</li> <li>• Thermochemical heat transformer.</li> <li>• Hybrid absorption-compression cycle using new standard components: maximum temperature of 180-250 °C (theoretical analysis).</li> </ul>

Electrification & Renewables to Displace Fossil Fuel Process Heating

	High-TRL Technologies	Mid-TRL Technologies	Low-TRL Technologies
<b>Heat exchangers</b>	<ul style="list-style-type: none"> <li>• Shell-and-tube, printed circuit heat exchangers: pressure up to 600 bar; operating temperature up to 800 °C.</li> <li>• Recuperators and regenerators operate with low pressure gases.</li> </ul>	-	-
<b>Concentrated Solar Thermal and Solar Thermal</b>	<ul style="list-style-type: none"> <li>• Evacuated Tube, Parabolic Troughs,</li> </ul>		
<b>Electric heating</b>	<ul style="list-style-type: none"> <li>• Microwaves: direct heating of food; power output of 1s-10s kW; dimension up to <math>\approx 4\text{m}^3</math>.</li> <li>• Radio frequency: direct heating of food; power output of 1s-10s kW.</li> <li>• Infrared: direct heating of food &amp; spacing heating; 12 kW for 50.7 m<sup>2</sup> workspace.</li> <li>• Drawbacks: target material should be relatively homogeneous.</li> </ul>	<ul style="list-style-type: none"> <li>• Using a silicon carbide target with a microwave.</li> </ul>	<ul style="list-style-type: none"> <li>• Electromagnetic heating.</li> <li>• Ohmic heating and magnetic induction: high efficiency close to 100%.</li> </ul>
<b>Thermal energy storage</b>	<ul style="list-style-type: none"> <li>• steam accumulator: commercially available; short-term storage.</li> <li>• Packed bed sensible: rock, ceramic and steel as storage medium; usually air as the heat transfer fluid (HTF); storage temperature &gt; 600 °C.</li> <li>• Coil-in-tank sensible: steel, concrete, graphite as storage medium; water/steam as the HTF; storage temperature &gt; 500 °C.</li> <li>• Coil-in-tank latent: PCM composite as storage medium; water/steam as the HTF; storage temperature of 565 °C.</li> <li>• Thermochemical: metal oxide as storage medium; air and water as the HTF.</li> <li>• Modular or large scale.</li> </ul>	<ul style="list-style-type: none"> <li>• Static &amp; dynamic latent: silicon, inorganic salts, salt mixtures as storage medium.</li> <li>• Latent with liquid air as storage medium.</li> <li>• Thermochemical: zeolite and metal hydroxides as storage medium.</li> <li>• Some technologies have been commercialized to produce electricity but not demonstrated to produce heat directly.</li> </ul>	<ul style="list-style-type: none"> <li>• Improvement and development of storage medium, e.g. ionic liquids, doping nanoparticles.</li> <li>• Stability and compatibility testing of materials.</li> </ul>

3.7.1 *Research gaps, barriers, and opportunities*

**Research Gap: High temperature heat pumps and MVRs**

- Heat pump technology is one (of the many) key technologies that can potentially significantly reduce cost and emissions for process heating, particularly in the temperature range <150°C.
- However, while heat pumps are already commonly used at low (close to ambient) temperatures, high temperature heat pumps are not yet a mature technology.
- Therefore, there is a need to accelerate the development and uptake of high temperature heat pump technologies.
- Mechanical vapour recompression technologies have demonstrated susceptibility to the use of contaminated water vapours which need to be overcome.

**Research Gap: Electromagnetic technologies**

- Microwave, infrared and radio frequency heating have been demonstrated in industrial settings.
- These systems have demonstrated power outputs of less than 100 kW.
- Homogeneous heating is a significant barrier for EM heating systems.
- Infrared space heaters are highly efficient because they do not heat air directly.
- Alternative non-thermal technologies (e.g. UV sterilisation, reverse osmosis) to replace processes currently requiring heat.
- Feasibility of EM assisted cascaded heating should be evaluated to reduce energy consumption and produce rapid heating.

**Research Gap: Improving heat transfer and thermal efficiency in existing technologies**

- Existing thermal technologies using conventional designs and traditional manufacturing processes provide opportunities for further improvements in energy efficiency across multiple scales.
- Geometric, chemical, or aerodynamic methods to reduce fouling and/or increase heat transfer and heat transfer efficiency.
- Utilise recent advancements in understanding of fluid mechanics to improve convective heat transfer in existing thermal technologies.

## 4 Market Potential

### 4.1 Introduction

This section provides an analysis of the potential to displace fossil fuel use for industrial process heat requiring temperatures up to 150 °C for three major sectors industrial sectors in Australia identified in the Market Status section, namely manufacturing, food & agriculture and healthcare & hotel buildings. This analysis is based on data obtained in the Market Status analysis, and only considers technology options identified in the Technology Review.

The approach taken involves applying renewable energy solutions to meeting heating loads that are technically feasible today. A simple techno-economic analysis was conducted of various technology solutions, which in turn informed estimates made for the uptake of different renewable energy technologies. From this analysis it was possible to identify the potential greenhouse gas savings over time in each sector.

The techno-economic assessment conducted is basic in nature and does not attempt to consider the integration complexities and associated costs of individual processes and technologies. More sophisticated process modelling, and techno-economic modelling tools do exist, however, these the use of these are beyond the scope of the current OA. In the current analysis, configurations developed are based on investing in on-site renewable solutions, energy efficiency measures and electrification of process heat together with renewable energy generation (e.g. solar PV) and/or the purchasing of emissions-free electricity through power purchase agreements (PPAs). Furthermore, no quantitative consideration is made for the decarbonisation of the electricity grid or any decarbonisation of the gas grid. In addition, no quantitative consideration is made for investments on an economic basis which are not focused on decarbonisation. Analysis of these options have been the subject of other studies and therefore will not be replicated herein. Rather all these factors are notionally identified as drivers for an accelerated scenario of technology uptake. The basis of this approach is primarily to focus on the potential of renewable energy technology in isolation, to highlight its market strengths and weaknesses, to provide guidance as to how to develop and implement these technologies.

This assessment is not a prediction or forecast, but a comparative scenario analysis demonstrating the techno-economic characteristics of renewable energy. Present and estimated future capital expenditures (CAPEX) and efficiencies of renewable energy technology are considered. Future values are selected based on a “what if” scenario and reflect notional estimates rather than forecasts. Consequently, this market potential analysis aims to highlight the potential of renewable energy solutions, and what research questions are needed to be solved to realise this potential.

The present analysis utilises an innovation diffusion model to estimate technology uptake rates and their impacts. The model focusses on two scenarios, namely a Business-as-Usual (BaU) case and an Accelerated Scenario (ACL) case. In the BaU scenario, current uptake rates are estimated based on past trends and historical data, where available. In the ACL scenario, a specific decarbonisation target of a 50% reduction in GHG emissions relative to present (typically the year 2020) emissions by the year 2035 was set. In both scenarios, market growth (both positive and negative) is also taken into account. A required technology uptake rate to meet this target can then be estimated and compared with the predicted uptake rate estimated under the BaU scenario. This then provides a direct estimate of the required acceleration in the uptake rates required to meet the emissions targets.

It should also be noted that the present opportunity assessment focusses on industrial heat processes where the process temperature is <150 °C. However, in the present analysis, individual process temperatures slightly above this range are also included if it is part of an overall process flow where



most of the heat is supplied <150 °C. Additionally, where heat transfer fluid (HTF) temperatures are available in lieu of process temperatures, the analysis includes processes with HTF temperatures ≤200 °C-250 °C because the HTF temperatures are typically higher than the process temperatures.

#### 4.2 Uptake Scenario Modelling

For this opportunity assessment, it is assumed that adoption of any changes to current operations (e.g., adoption of a renewable technology to replace existing systems) will follow a simplified innovation diffusion model based on logistic growth in change uptake [212, 213]. An example of the uptake rates predicted by such a model, as well as the underlying rationale behind the use of the model, is shown in Figure 59. For example, the first underlying assumption for predicting the growth in market share for a new technology is that only a small percentage of the relevant population will adopt the technology early on while the risk is high (innovators, early adopters). Once the new technology has gained sufficient market share to increase confidence, uptake rates accelerate (early majority). Once the remaining market share is composed primarily of a more hesitant/risk-averse population (late majority and laggards), uptake rates decelerate, eventually asymptoting towards the upper limit of market share for the technology in question. While there have been many modifications and variations of this concept, applying different functions to better predict different behaviours, the basic logistic model has been shown to be adequate for modelling growth/diffusion in a wide array of fields [212].

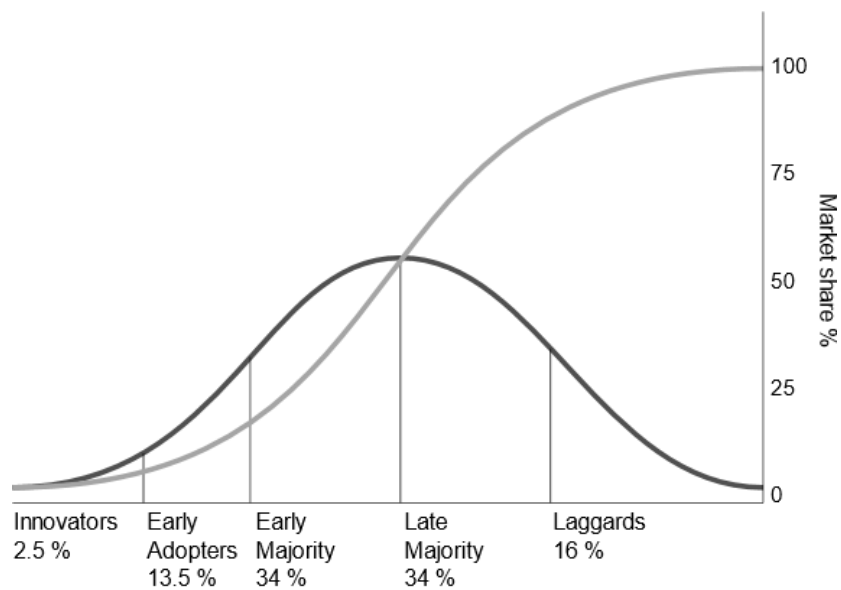

Figure 59. Example technology uptake rate based on a logistic innovation diffusion model. Adapted from [213].

In the logistic growth model, the market penetration of technologies (i.e. renewable energy technologies) at a particular time,  $t$ , is

$$P(t) = \frac{P_0 K \exp(rt)}{(K - P_0) + P_0 \exp(rt)}$$

where  $P_0$  is the initial (i.e. current) market penetration,  $K$  is the maximum potential market share (typically 100%) and  $r$  is the growth factor.

Competition between different technologies or investments can be modelled by dividing the potential market share for each competing investment as a separate value which also changes with time. The uptake capacity is then assumed to be shared for all competing technologies/investments such that uptake gained by one is no longer available to any other. Therefore, for mutually exclusive investments,  $K(t)$  for a given investment option at any point in time should equal the overall investment uptake capacity of the industry or market in question, minus the combined uptake of any competing investments at the same point in time.

A detailed analysis of how external and internal market factors quantitatively affect these parameters is beyond the scope of this study. However, qualitative estimation based on analysis of, and experience with, specific industries and technologies will allow sufficient depth to estimate appropriate values. For modelling the accelerated scenarios, the logistic function parameters (primarily the growth factor,  $r$ ) are manipulated to ensure that the 2035 emissions targets are met. The difference in these parameters between BaU and accelerated scenarios then gives an indication of the relative effort needed to transition from one scenario to the other.

Due to the differences in the characteristics of each industry, the specifics regarding how the technology uptake rates have been estimated, and how the model is applied vary for different industrial sectors and will be discussed in the relevant sub-sections.

To quantify the effect of the renewable technology uptake rates on the greenhouse gas emissions and the ongoing fossil fuel energy costs, the greenhouse gas factors, and the price of fuels as specified in Table 25 are used for the current analysis. The use of these values is discussed in more detail below.

*Table 25: Values used to estimate reduction in greenhouse gas emissions and energy costs for both the business-as-usual and accelerated scenarios. Greenhouse gas emission factors obtained from the Department of Industry, Science, Energy, and Resources [214], while gas prices were obtained from the Australian Energy Market Operator [215]. All other energy costs are from ITP Thermal Pty Ltd [2].*

Energy source	GHG emissions factor (kg CO <sub>2,eq</sub> /GJ)	Cost (\$/GJ)	Comments
Coal	90.24	\$4.00	Price assumed to remain constant for the next 15 years
Natural gas	51.53	\$11.00	Average price for the next 15 years, assuming price to increase from ≈\$9/GJ (current) to \$13/GJ (by 2035)
LPG	60.6	\$38.00	Price assumed to remain constant for the next 15 years
Electricity	236.1	\$28.00	Price assumed to remain constant for the next 15 years. Emissions factor assumed to decrease at the uptake rate of renewable energy technologies.

#### 4.2.1 Assumptions and limitations

It should be re-iterated that the uptake scenario modelling is a highly simplified model which makes a large number of assumptions. Therefore, the results of the model should not be used as a predictive

tool in any way, however, it is intended to provide a like-for-like estimation of the scale of improvement that can be anticipated for the different sectors considered in this report.

More specifically, the major assumptions for the uptake modelling include, but are not limited to:

- a) The uptake of technologies follows the logistic growth model;
- b) For each sector, a single constant growth factor,  $r$ , is used. The only exception is the alumina processing sector, which was modelled to account for a step change in technology uptake;
- c) The growth in fuel/energy demand up to 2035 is assumed to grow/decline at the same rate based on the past 10-20 years of existing data (where available);
- d) The greenhouse gas emissions factors and the cost of fuel (as summarised in Table 25) remain constant up to 2035;
- e) The emissions factors, cost of fuel and fuel mix are not site or state specific. That is, a constant value is used for all sites and states;
- f) For sectors where electricity supplies a significant proportion of process heat (e.g. hotels and healthcare buildings), only a proportion of electricity is assumed to be provided via renewable sources. This proportion is equivalent to the renewable technology uptake;
- g) No pre-conceived assumption is made on which renewable technology option is selected for each site and/or sector. While the discussion provides the different technology options to decarbonise, the uptake model does not discriminate between the different technology options;
- h) Current market penetration (as of 2019) and growth factor under BaU scenario is based on a literature review of each industry conducted for this OA and the experience of the authors;
- i) Energy required for heating and associated fuel mix are assumed based on data available from Australian Energy Statistics and comparison with figures in Lovegrove et. al. 2019 [2].

It should also be noted that due to the lack of reliable information on actual/expected capital and running costs across the different companies, industrial processes, and fuel types, and for the different time periods in the future, all of the energy costs presenting in this section is for the ongoing fossil fuel energy cost only, with the cost per unit of fuel based on the values presented in Table 25. This ongoing fossil fuel cost does not take into account the additional costs of shifting the energy away from fossil fuels (e.g. cost of additional solar panels, cost of grid supplied renewables, etc., where relevant).

## 4.3 Manufacturing and Processing

### 4.3.1 Alumina and other non-ferrous metals

#### Market potential at a glance

- As of 2020, the non-ferrous metals sector currently consumes 333 PJ of energy per annum
  - Of this amount 190 PJ is for thermal processes for all temperature ranges, and 95 PJ for  $\leq 150^\circ\text{C}$
  - Process heat for  $\leq 150^\circ\text{C}$  contributes 6.1 Mt CO<sub>2,eq</sub> per annum
  - If no new renewables technologies are taken up, the energy demand, and associated emissions and costs, for this process heat are expected to increase at 0.52% per annum
- Alumina refining accounts for 62% of the scope 1 emissions for the non-ferrous metals sector
  - 58% of process heat in alumina refining is  $\leq 150^\circ\text{C}$
  - Process heat  $\leq 150^\circ\text{C}$  in alumina refining contributes 4.4 Mt CO<sub>2,eq</sub> per annum
  - The fossil fuel consumption for this process heat costs an estimated \$578 million per annum
- Based on a logistic technology uptake model targeting the alumina refining process, by 2035:
  - Under the BaU scenario, the emissions associated with process heat  $\leq 150^\circ\text{C}$  would increase to 4.5 Mt CO<sub>2,eq</sub> per annum (in line with overall growth in energy demand). It should be noted however that the two biggest alumina refinery operators (accounting for 5 out of 6 refineries) both have zero emissions targets for 2050. The reason for a projected near 0% change by 2035 is that the technology identified by industry as the most promising for decarbonising the Bayer process is not expected to be market ready until around that time. Once sufficiently developed, it is expected that the technology would see rapid adoption by the 6 Australian alumina refineries, allowing the 2050 target to be met.
  - Under the Accelerated Scenario, the emissions associated with process heat  $\leq 150^\circ\text{C}$  would be 2.2 Mt CO<sub>2,eq</sub> per annum. This is a reduction in emissions by 51.1% compared to the BaU scenario
  - Under the accelerated scenario, the cost of fossil fuel consumption by the alumina industry alone will be reduced by approximately \$302 million per annum relative to the BaU scenario
- To achieve the 50% emissions target by 2035, the development/proving of MVR technology for the Bayer process needs to be accelerated by a factor of approximately 67% compared to BaU scenario i.e. market ready by 2031 rather than 2035.

#### 4.3.1.1 Introduction

In 2017, the six alumina refinery plants in Australia accounted for 27% of the total scope 1 emissions for the manufacturing sector [216]. Based on the data reported in the Australian Energy Update [217], this represents approximately 62% of the overall scope 1 emissions for the non-ferrous metals industry. It is assumed for the purposes of this report that this proportion is representative of the last ten years, and, if no decarbonisation measures are adopted, will also hold true through to 2035. The RACE for 2030 B3 Market Status Report indicates that 58% of the scope 1 emissions for the alumina

refining process can be attributed to the low temperature Bayer process<sup>8</sup>, and 42% to the higher temperature calcination process. Therefore, the emissions from process heat below 150 °C in the alumina refining industry represents 43%-44% of the overall scope 1 emissions for the entire non-ferrous metals industry. The process diagram for alumina refining presented in the RACE for 2030 B3 Market Status Report is shown in Figure 8.

4.3.1.2 *Renewable energy technologies for heating demand in alumina refining*

While there has been some adoption of solar thermal energy to supply the low temperature heat requirements for alumina refining, MVR (mechanical vapour re-compression) has been identified as the most attractive long-term decarbonisation solution. This is based on the assumption that the energy grid will be decarbonised and its capacity increased to account for the approximately 1200MW increase in electrical energy demand that the adoption of this technology would require [216]. An additional benefit of MVR is that it closes the water loop in the Bayer process, potentially reducing the water consumption of the alumina refining sector by 25GL per annum. A schematic of how MVR would replace natural gas for steam generation is shown in Figure 60 [216].

It is estimated that in conjunction with decarbonising the electrical supply for the industry, adoption of MVR technology for the steam generation requirements in the Bayer process would represent a step change to complete decarbonisation of the process heat requirements around 150 °C. However, the compressor technology that would be required to retrofit the existing refinery plants in order to supply steam at a sufficient rate is estimated to be approximately 10-20 years away from being market ready. Additionally, retrofit costs are estimated to be in the order of 2-5 billion AUD, with the required development costs also representing a significant barrier [216].

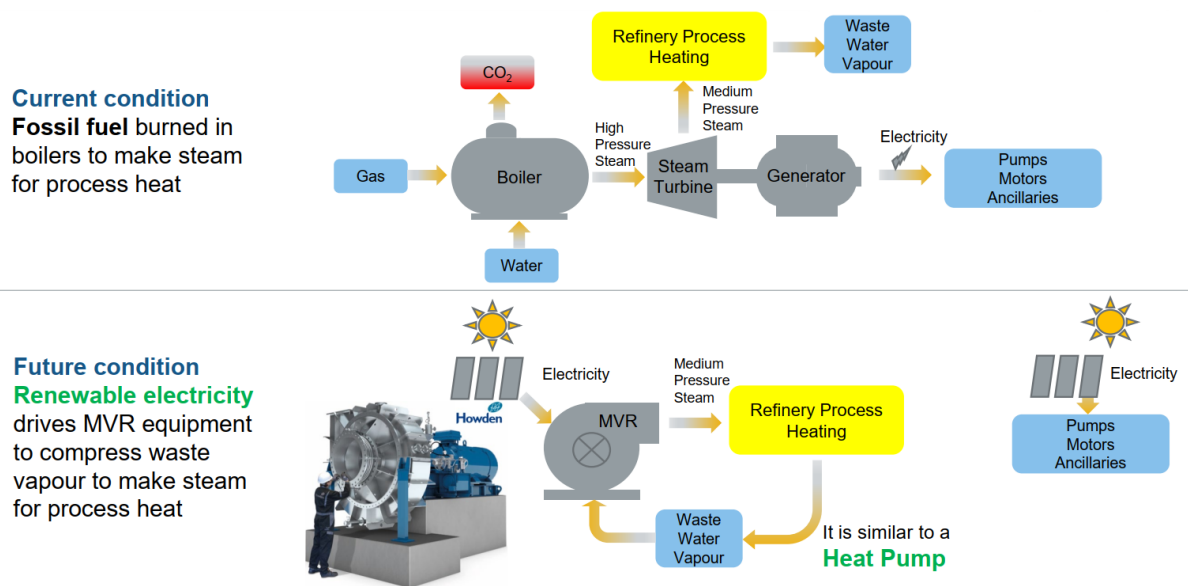

Figure 60. Use of MVR and renewable electricity to replace natural gas fired steam boiler and generator [216].

<sup>8</sup> Generally, the highest temperature required by this process is between 140°C and 180°C in the digestion stage, however in a small number of cases this can be up to 280°C. Heat is supplied in a cascading manner from this stage to the following stages that require heat at or below 100°C. Due to this process design, it is impractical to separate the heat supply requirements above and below 150°C, hence the entire Bayer process is treated as being in the 100-150°C temperature bracket with heat typically supplied to the process between 150°C and 250°C.

4.3.1.3 Uptake scenarios: Alumina refining

A growth rate of approximately 0.52% per annum, based on historical growth in energy demand in the non-ferrous metals industry, is used to project expected emissions for the industry in the absence of decarbonisation measures. It is assumed that each sector within the industry is growing at the same rate.

The equivalent CO<sub>2</sub> emissions for the mix of fuels used (primarily natural gas) can be calculated using the fuel combustion emission factors given in the National Greenhouse Accounts Factors [218]. This is shown for the alumina refining sector in Figure 61 from 2009 to 2019 and then projected through to 2035.

While the operating costs and auxiliary benefits of MVR technology are already attractive based on current economic factors (even in the context of retrofitting existing refineries), and there is significant interest within the industry to decarbonise, the barriers to development of market ready and proven compressor technology are still significant and will require significant investment to overcome. It is therefore assumed that for a business-as-usual scenario, the required compressor technology will not be market ready until 2035, resulting in minimal emissions reductions before then.

Due to the expected step change that adoption of this technology will allow, it is possible that this would still enable complete decarbonisation of this process by 2050, however, to meet a 50% reduction target by 2035, development of compressor technology for MVR steam supply in alumina refining will need to be accelerated. This is shown in Figure 61 where it can be seen that as long as the technology required for MVR integration in the Bayer process can be made market ready, and successfully retrofit to one of the six current refineries by around 2031, it is likely that adoption of the technology by the remaining refineries will accelerate, allowing the 2035 target to be met. The logistic technology uptake model discussed in Section 4.2 was used to determine the accelerated rate of uptake of MVR in the alumina refining industry and the associated emissions reduction. The growth factor, *r*, was set to ensure a 50% reduction in emissions from process heat below 150 °C. However, to model the expected step change behaviour, it was also assumed that the growth factor would increase by 25% after the first refinery adopted a functional MVR process heat supply system (taken as a market penetration of 16%).

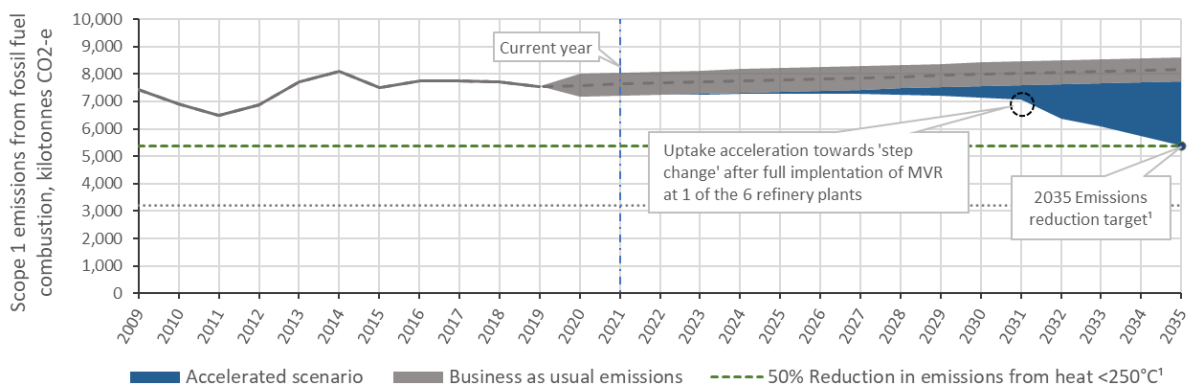

Figure 61. Projected BaU scope 1 equivalent CO<sub>2</sub> emissions and reduction in emissions as a result of accelerated development of MVR steam supply technology for alumina refining.

<sup>1</sup> 2035 emissions reduction target based on a 50% reduction in emissions associated with process heat below 150 °C relative to 2019 levels. Heat is currently supplied to these processes between 150 °C and 250 °C.

## Electrification & Renewables to Displace Fossil Fuel Process Heating

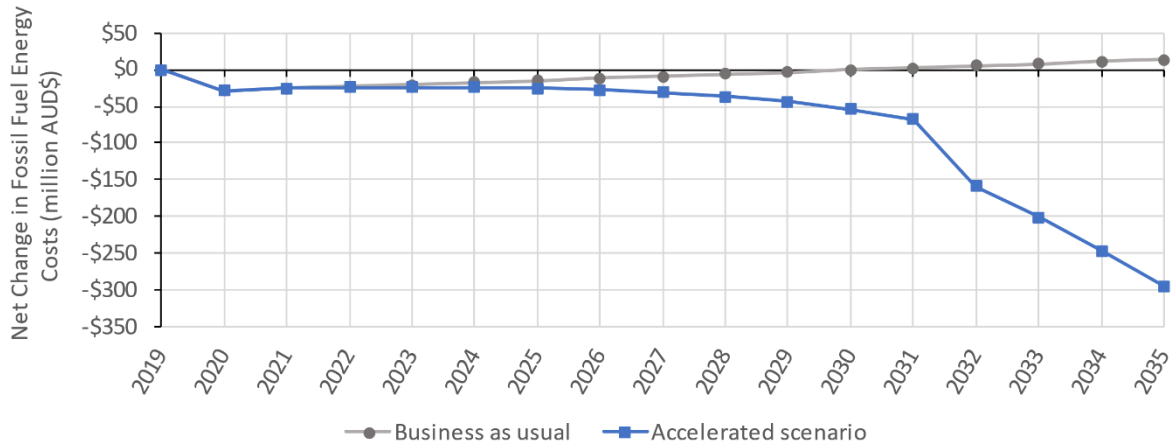

Figure 62. Net change in fossil fuel energy cost for Australian alumina refining relative to 2019 levels.

Figure 62 shows the estimated net change in annual fossil fuel energy cost for the Australian alumina refining industry. The results show that by 2035, a net saving of approximately 295 million AUD per annum can be released under the accelerated scenario relative to 2019 levels. Importantly, under the business-as-usual scenario, the annual fossil fuel energy use is projected to increase beyond 2019 levels by 2035, corresponding to an increased cost of 14 million AUD per annum. That is, the accelerated scenario will result in a saving of approximately 309 million AUD per annum relative to the BaU scenario.

### 4.3.2 Wood and wood products

#### Market potential at a glance

- As of 2020, the wood & wood products sector currently consumes 16.9 PJ of energy per year.
  - Of this amount 13.7 PJ is for thermal processes for all temperature ranges, and 5.5 PJ for  $\leq 150$  °C.
  - Process heat for  $\leq 150$  °C contributes 58 kt CO<sub>2,eq</sub> per annum.
  - If no new renewables technologies are taken up, the energy demand for this process heat is expected to increase at 0.93% per annum.
- Wood drying accounts for 35% of the process heat consumption across all temperature ranges.
  - Process heat for wood drying is all  $\leq 150$  °C, contributing 50 kt CO<sub>2,eq</sub> per annum;
  - The fossil fuel cost associated with this process heat is approximately \$9.7 million per annum
- Based on a logistic technology uptake model targeting the wood drying process, by 2035:
  - Under the BaU scenario, the emissions for wood drying process heat  $\leq 150$  °C would be 44 kt CO<sub>2,eq</sub> per annum. This is a reduction in emissions by 12% to 2019 levels.
  - Under the Accelerated Scenario, the emissions for process heat  $\leq 150$  °C would be 25 kt CO<sub>2,eq</sub> per annum. This is a reduction in emissions by 43% and 50% compared to the BaU scenario and 2019 levels respectively;
  - Under the ACL scenario, the fossil fuel energy costs will be reduced by \$3.7 million per annum relative to the BaU scenario
- To achieve the 50% emissions target by 2035, the uptake rate of renewable technologies over the next 5 years needs to be accelerated from  $\approx 0.13\%$  per year to 0.7% per year (i.e. a factor of 6.4). It is also recommended that significant investments in emissions reducing projects that do not allow for 100% emissions reduction be limited as much as possible. These projects will need to start being redeveloped in the near future in order to allow sufficient adoption of 100% renewable options and would hence represent unnecessary cost to the industry as a whole.

#### 4.3.2.1 Introduction

In the RACE for 2030 B3 Market Status Report, lumber processing and drying, was identified as one of the major heat users at temperatures below 150 °C, accounting for approximately 35% of the heat use in the wood and wood products sector (ANZSIC group 14) as a whole. The Market Status Report indicated that the drying process accounts for the entirety of the heat consumption, and 70% of the overall energy usage for the process. While heat is typically supplied at 170-180 °C, the maximum process temperature is around 75°C, hence the timber drying process is considered to be a major contributor to process heat demand below 150 °C.

The heat consumption is concentrated in the controlled final drying stage, where air flow rate, relative humidity and temperature need to be controlled to maintain final timber quality. In some cases, heat is also used for pre-drying, however this stage requires both much lower temperatures and less controlled conditions. It therefore often occurs using ambient (unheated) air.



4.3.2.2 *Renewable energy technologies for heating demand in lumber processing*

While renewable heat supply technologies (e.g. solar thermal) could potentially be implemented as a straight substitution to the natural gas boiler in a ‘standard’ kiln, there are also alternative renewable energy kiln designs (as summarised in Table 26) which already exist that can remove the need for fossil fuels in this process. These alternative designs have historically had a few drawbacks which have prevented more widespread adoption by the industry. This presents possibilities for additional research into solutions that may be able to overcome these shortcomings. The existing renewable energy kiln designs, as well as potential research opportunities are discussed in more detail below.

Table 26. Renewable energy technologies for heating demand in wood drying

Renewable energy wood drying kilns		TRL
<b>Commercially available solutions</b>	Solar kilns	7-8
	Heat pump dehumidifier (HP-D) kilns	7-8
<b>Novel solutions</b>	CHP + Solar or HP-D kiln	5-6
	Desiccant based dehumidifier kiln	5-6

4.3.2.2.1 *Solar kilns*

Solar kilns come in a number of configurations including greenhouse, semi-greenhouse and conventional insulated kilns with separate solar thermal collectors for heat supply [219]. They have several advantages including low capital cost and low-zero running costs. However, they also exhibit drawbacks in that the heat supply is intermittent in the configurations without thermal storage. In greenhouse type kilns, the maximum temperature is limited, and precise control over internal conditions is more difficult. Solar kiln designs using external collectors with thermal storage don’t share these same limitations, but also represent a higher capital cost. These kilns effectively act as a replacement to a natural gas boiler in a standard kiln design, hence allowing the same level of process control. The limiting factor for these designs is the availability of solar energy at the site in question. While relatively simple solar thermal collectors are available that are capable of providing the required temperatures [2] (e.g. evacuated tube collectors), an auxiliary heat source is generally included to offset the variability of solar energy. This could be provided by a biomass burner utilising the available wood waste, or by natural gas or electricity if sufficient wood waste is not available.

While with sufficient solar exposure, external solar thermal collectors could supply the process heat for final drying, greenhouse type solar kiln designs are perhaps more suitable for use in the pre drying stage due to the lower temperature requirements and more relaxed control schedules.

It is also possible that the perceived drawback associated with intermittent heat supply and lower maximum temperatures in solar thermal kilns may result in product quality improvements such as reduced internal stresses leading to reduced warping and cracking [219]. However, this would require additional research and case studies before confidence in such an assertion would be high enough to

encourage more widespread adoption on these grounds. Any potential benefits would also have to be weighed against increased process time resulting in reduced production rates.

Figure 63 shows a possible implementation of a simple greenhouse type solar kiln for the pre-drying stage with a separate collector type solar kiln with a backup heating circuit utilising a biomass boiler to take advantage of the available wood waste.

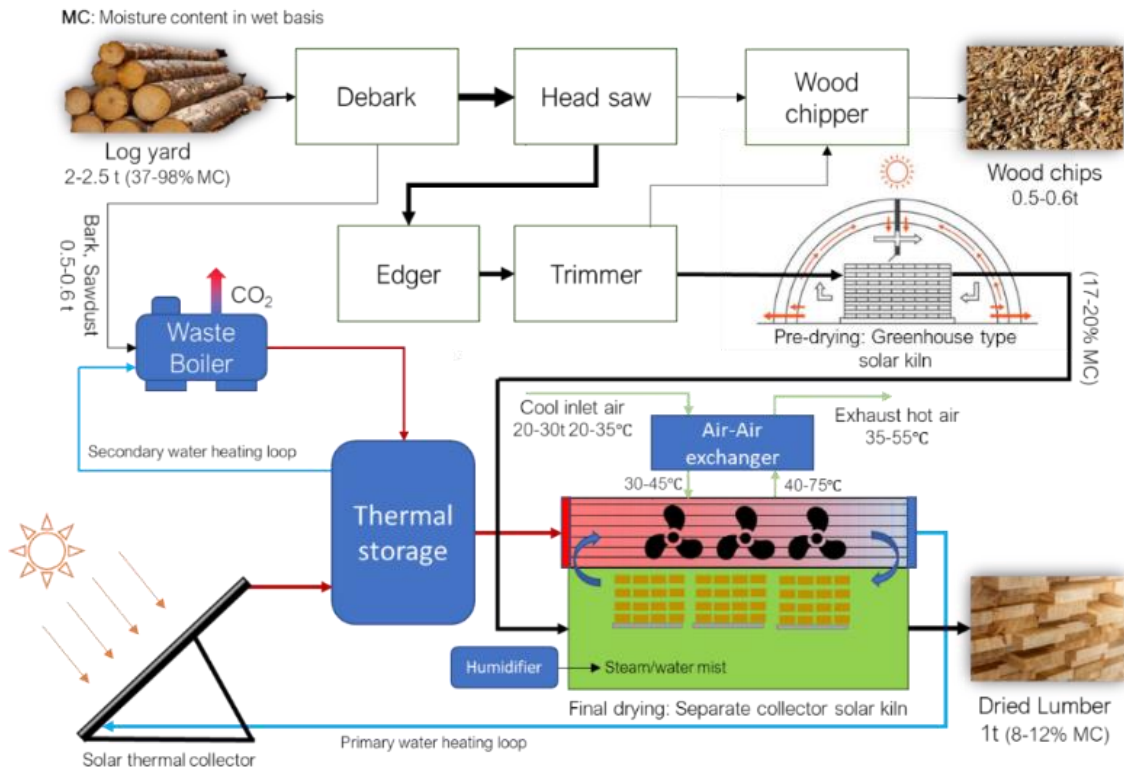

Figure 63. Possible implementation of solar kiln with waste heat temperature boosting/backup.

#### 4.3.2.2.2 Heat pump dehumidification

Heat pump dehumidifier kilns are another existing (commercially tested) design capable of eliminating fossil fuel use for process heat. In a standard steam heated kiln design (Market status report), a substantial amount of heat is lost through exhausted air in order to control the humidity within the kiln. Dehumidifier designs utilise heat pumps to both condense the moisture from the humid air and recover this heat in a closed cycle, substantially reducing heat losses. The use of a heat pump also further reduces the energy supply requirement, needing approximately 1/3 to 1/4 of the process heat demand as electrical energy (for a heat pump with a COP<sub>heating</sub> of 3-4). If this electrical energy is obtained from a renewable source - either through supply contracts or onsite generation, then the net emissions from the drying process can be eliminated. An example implementation of a HP-D kiln with grid connected solar is shown in Figure 64.

These kilns have several benefits in terms of energy demand and process control (which results in more consistent or improved product quality), however historically, the running costs have been high in comparison to gas fired kilns. Capital costs are, however, generally lower [219]. With improvements in heat pump technology and increasing gas prices, the difference in running costs between gas fired kilns and HP-D kilns is likely to become significantly smaller, potentially even switching to favour HP-D technology. Another consideration for this technology is its performance across the entire temperature range of the drying schedules. Due to the low temperatures required at the evaporator

for dehumidification, the temperature lift of the heat pump increases with any increase in air temperature required. This can negatively impact the COP and hence increases the electrical energy demand. Careful selection of heat pump could mitigate this<sup>9</sup>, however another solution could also be to include an auxiliary heat source to boost the temperature where required. This has the added advantage of being able to provide pre-heating during kiln start-up.

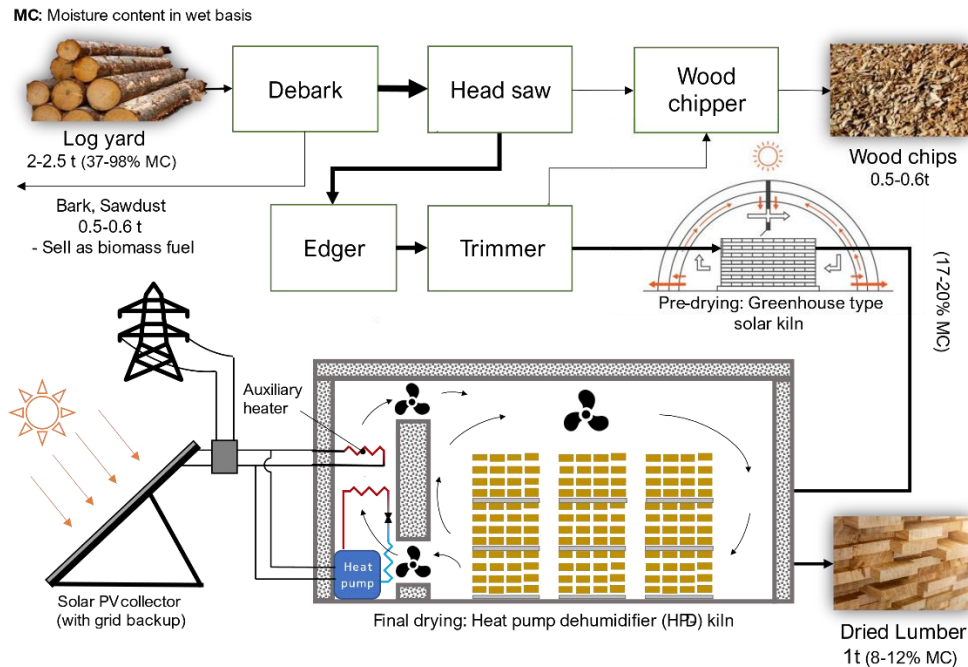

Figure 64. Implementation of a heat pump dehumidifier kiln with onsite solar PV. Onsite solar PV could also be replaced with grid electricity from renewable sources.

#### 4.3.2.2.3 Novel renewable kiln designs

Utilisation of the waste wood as a fuel in a biomass burner (or gasifier) combined heat and power (CHP) unit where the CHP unit provides electricity to run the heat pump as well as any auxiliary heat requirements (as shown in Figure 65a) is an area of research that could yield promising results. Use of a wood gasifier CHP coupled with a standard wood drying kiln has been explored [220]. The CHP unit was able to provide 52.6% of electrical, and 38.9% of thermal energy requirements for the sawmill. It is estimated that a similar CHP unit should be capable of providing the input requirements to run a HP-D kiln.

As an alternative to a CHP + HP-D kiln, a desiccant based dehumidifier could also be included which would effectively decouple the dehumidification and temperature control functions. The key advantage of such a system would be the ability to size the heat pump for a constant temperature lift, thereby allowing the COP to be better optimised.

While the individual components of these proposed solutions are at a high TRL (heat pumps, gasifier CHP), it is estimated that the combined system is approximately at a TRL of 5-6, indicating that additional case studies and research will likely be required before industry confidence is high enough for widespread adoption.

<sup>9</sup> An appropriate heat pump for this application identified in the technology review might be the Dürr thermae CO<sub>2</sub> heat pump.

## Electrification & Renewables to Displace Fossil Fuel Process Heating

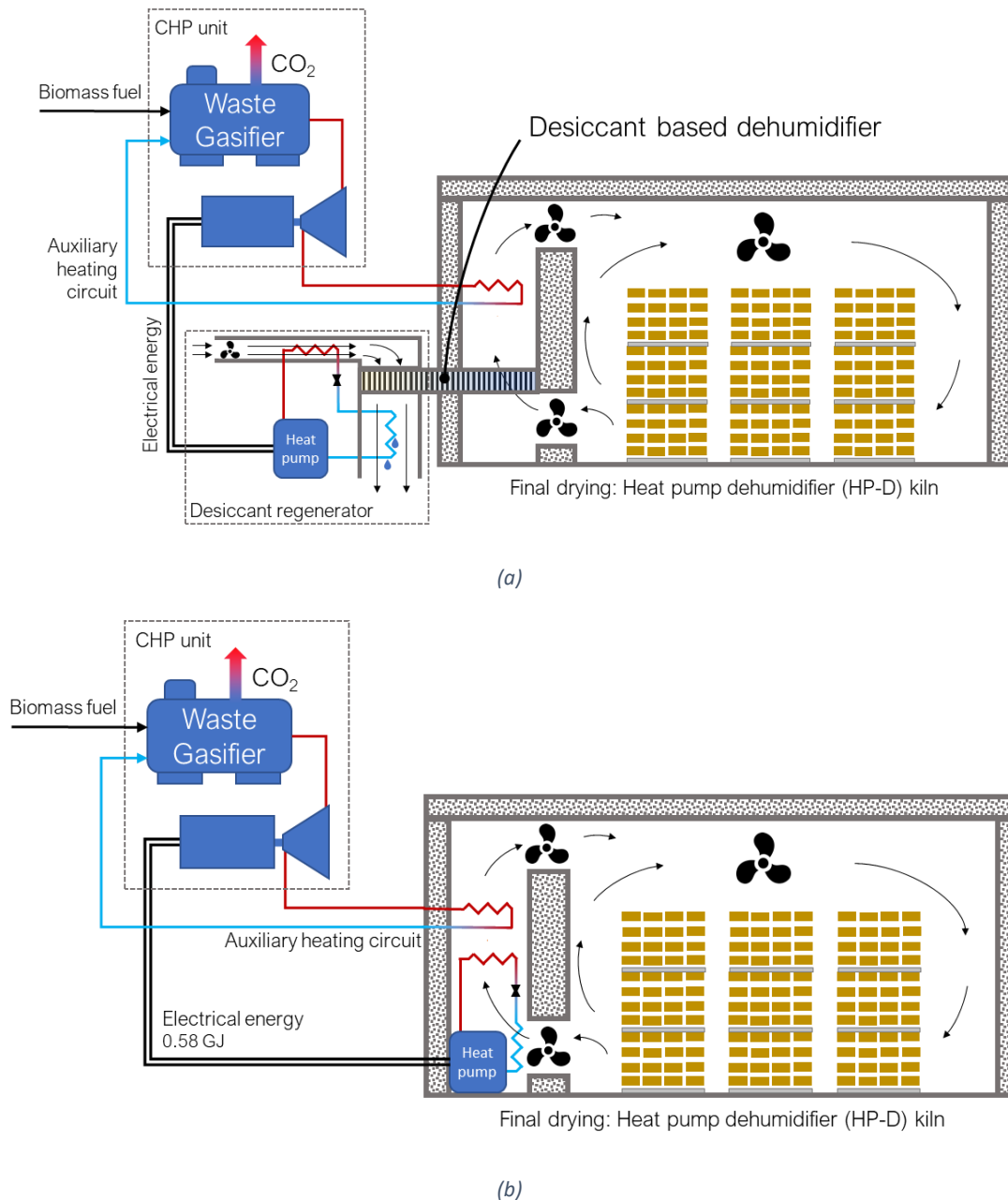

Figure 65. Implementation of a CHP unit powering a HP-D kiln and providing auxiliary heating. (a) Heat pump + desiccant dehumidifier. (b) Direct heat pump dehumidifier.

### 4.3.2.2.4 Impact of location on renewable wood drying technologies

In the majority of locations where lumber drying takes place, the solar exposure is similar [221, 222]. However, the difference between those sites at the extreme ends of this spectrum is of note. For example, a HP-D system using solar PV near Hobart would require approximately 67% more collector area for the same production volume compared to one near Brisbane. However, the percentage of energy supplied by renewables in Tasmania (predominantly from Hydro) is approximately 96% [223]. So, in this case, a grid connected system would likely be more attractive while still taking advantage of a renewable electricity supply.

4.3.2.3 *Uptake scenarios: Wood drying*

Energy demand data reported in the Australian energy update [217] shows an historical growth in energy demand of approximately 0.93% per annum for the wood and wood products sector. It is assumed for the purpose of this analysis that this rate will continue through to 2035.

The projected emissions associated with the combustion of fossil fuel for heat in the timber drying sector under business as usual and accelerated renewable uptake scenarios emissions are based on this expected growth in overall energy demand for the industry and calculated from projected fuel consumption using fuel combustion emission factors given in the National Greenhouse Accounts Factors [218].

A realistic BAU scenario will also include some level of energy demand reduction per unit of product compared to historical levels. The kinds of process or plant upgrades, considered here as general upgrades, range from basic efficiency upgrades ( $\approx 10\%$  efficiency improvement) to large scale redevelopments that are capable of up to 40% reduction in fossil fuel demand [224].

The following assumptions have been made in modelling BAU and accelerated scenarios:

**Business as usual:**

1. There are no enforceable emissions reduction targets in place.
  - a. Cost, both CAPEX and OPEX, will be a primary driver behind investment decisions, with emissions reduction being secondary.
  - b. Any renewable heating investments will be sized to maximise cost savings, and will therefore operate at a reduced capacity factor (taken as between 60% and 80%)
2. General upgrades are assumed to be more attractive financially than adoption of alternative process heat technology.
  - a. Uptake rate of general upgrade investments is assumed to be in the order of 1-5% per year

**Accelerated emissions reduction:**

1. There are no enforceable emissions reduction targets in place, however there is nominal agreement to reduce emissions.
  - a. Emissions reduction potential will be considered alongside CAPEX and OPEX considerations
  - b. Competition will exist between partial emissions reduction investments and complete decarbonisation investments.
2. The uptake rate of general upgrade investments and partial decarbonisation will be the same in the accelerated scenario as for BAU.
  - a. The required uptake rate of complete decarbonisation options will be determined such that the emissions reduction targets are met.

**Common assumptions:**

3. It is assumed that approximately 50% of sites have some capacity to apply the sort of general upgrades mentioned above.
  - a. Emissions reduction potential (ERP) of general upgrades will be between 10% and 40%. An average ERP for general upgrades of 25% is used.

- b. ERP of general upgrades is assumed to be capped for the life of the investment i.e. reducing emissions beyond this amount would require substantial additional investment.
4. It is assumed that current market penetration of renewable process heat technologies is minimal<sup>10</sup>.

As discussed in Section 4.2, uptake rates for any changes to current operations will be modelled using a logistic growth function. The logistic function parameters for the BAU and accelerated scenarios are summarised in Table 27. The growth factor (*r*) for general upgrade investments was set in order to give the assumed uptake rate of between 1% and 5% per year. This figure was then used as a benchmark to set the growth factor for renewable heat investments with reduced capacity factor for both BAU and accelerated scenarios. The selected value of 0.15 results in an uptake rate within the lumber drying sector for these investments of between 0.14% and 0.25% per year. The difference in uptake rates between these two options (with the same growth factor) is due to the difference in the current market adoption. General upgrades of existing technology have a proven track record and hence are expected to maintain a greater uptake rate.

The growth factor for 100% renewable heat supply investments used in the accelerated scenario was set to ensure that the 2035 emissions reduction target would be met. The difference between this required growth factor (*r*=0.325) and the expected growth factors for the other investment options indicates the relative effort required to move from the BAU projections to a 50% decarbonisation of process heat below 150 °C by 2035. Once the cumulative uptake of each investment option is determined for each year using the logistic model (see Section 4.2), the associated reduction in emissions is calculated by applying the relevant emissions reduction potential factor (ERP) from Table 27 to the increase in uptake for that year with respect to the previous year.

Table 27. Logistic function parameters and emissions reduction potential for the BaU and accelerated uptake scenarios

Uptake scenario model parameter		Emissions reduction investment option		
		General upgrade	Renewable (70% CF)	Renewable (100% CF)
Potential market penetration <sup>11</sup>	$K_0$	100%	100%	100%
Initial adoption level (as of 2021)	$P_0$	50%	1%	1%
Growth/uptake factor	<i>r</i>	0.15	0.15	0.325
Emissions reduction potential	ERP	25%	70%	100%

The BAU scenario shown in Figure 66 gives an indication of the expected upper and lower bounds of scope 1 emissions from fossil fuel combustion by 2035 for the wood drying sector if no interventions

<sup>10</sup> This does not include the heat currently supplied by wood waste but refers to alternative technologies to displace natural gas or coal use.

<sup>11</sup> With respect to the overall wood and wood products industry. i.e. 30% represents 100% adoption within the lumber drying sector. This approach is used in order to show the emissions reduction potential of decarbonising the lumber drying sector with respect to overall emissions for the wood and wood products industry.

## Electrification & Renewables to Displace Fossil Fuel Process Heating

are taken. The emissions reduction target shown is calculated with respect to 2019 emissions and is based on a 50% reduction in emissions from process heat for the lumber drying sector.

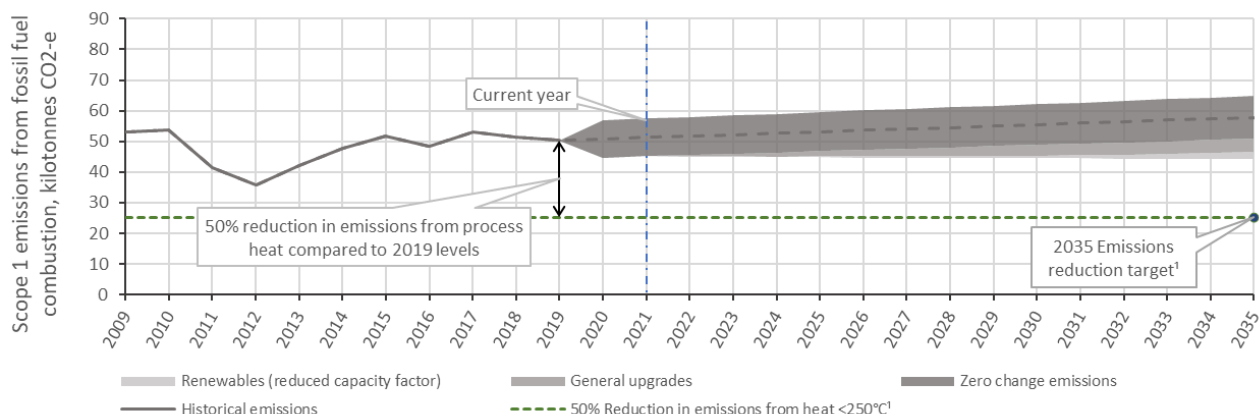

Figure 66. Business as usual projection of scope 1 equivalent CO<sub>2</sub> emissions from fossil fuel combustion in the timber drying process including potential reductions in emissions due to investment in energy saving upgrades.

<sup>1</sup> 2035 emissions reduction target is based on a 50% reduction in heat use below 150 °C with respect to 2019 levels. Heat is currently supplied to this process between 150 °C and 250 °C.

Figure 67 shows the projected scope 1 emissions levels associated with process heat for the timber drying process under an accelerated emissions reduction scenario. Figure 68 (a) shows the associated market penetration for each investment type through to 2035. This suggests that under an accelerated scenario, by 2035, the whole of the lumber processing industry will have invested in some form of emissions reducing technology. Approximately 47% will need to have adopted complete decarbonisation solutions, however the remaining 53% will likely have invested in partial decarbonisation options. Additionally, around 34% of operations that adopt general upgrades over renewable heat supply technologies before 2029 will need to have further invested in upgrading to 100% renewable heat supply technology between 2029 and 2035. If this re-investment does not occur, the uptake of renewable heat supply technologies would be limited to that shown in Figure 68(a), nearly halving the potential emissions reductions by 2035. Figure 68 (b) shows the effect of limiting the rate of investment in partial decarbonisation options. It can be seen that the market penetration of 100% renewable technologies by 2035 does not decrease (resulting in the emissions reduction target still being met). However, a significantly smaller amount of re-investment would be required to meet the 2035 target. The example shown halves the growth factor of general upgrades which results in only 23% needing additional investment compared to the 34% in Figure 68(b) and the year at which this becomes necessary is delayed until 2030.

Figure 69 shows the estimated net change in annual fossil fuel energy cost for the Australian timber processing industry. The results show that by 2035, a net saving of approximately 4.8 million AUD per annum can be released under the accelerated scenario relative to 2019 levels. Under the business-as-usual scenario, the annual fossil fuel energy use is expected to decrease slightly beyond 2019 levels, corresponding to a saving of 1.2 million AUD per annum by 2035. Therefore, the accelerated scenario will result in a saving of approximately 3.6 million AUD per annum relative to the BaU scenario.

## Electrification & Renewables to Displace Fossil Fuel Process Heating

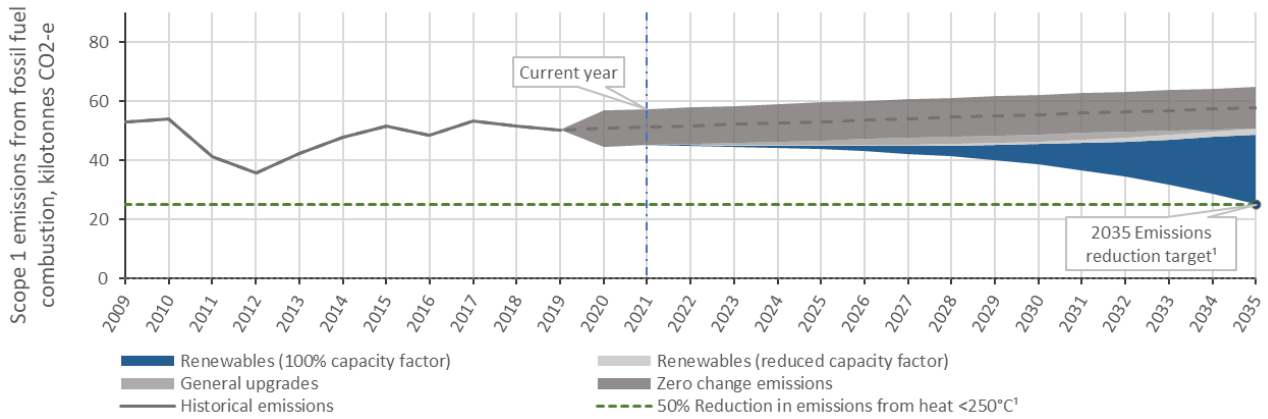

Figure 67. Projection of accelerated emissions reduction through to 2035. Emission levels are scope 1 equivalent CO<sub>2</sub> emissions from fossil fuel combustion in the timber drying process.

<sup>1</sup> 2035 emissions reduction target is based on a 50% reduction in heat use for lumber drying with respect to 2019 levels which translates to 15% reduction in overall emissions from process heating.

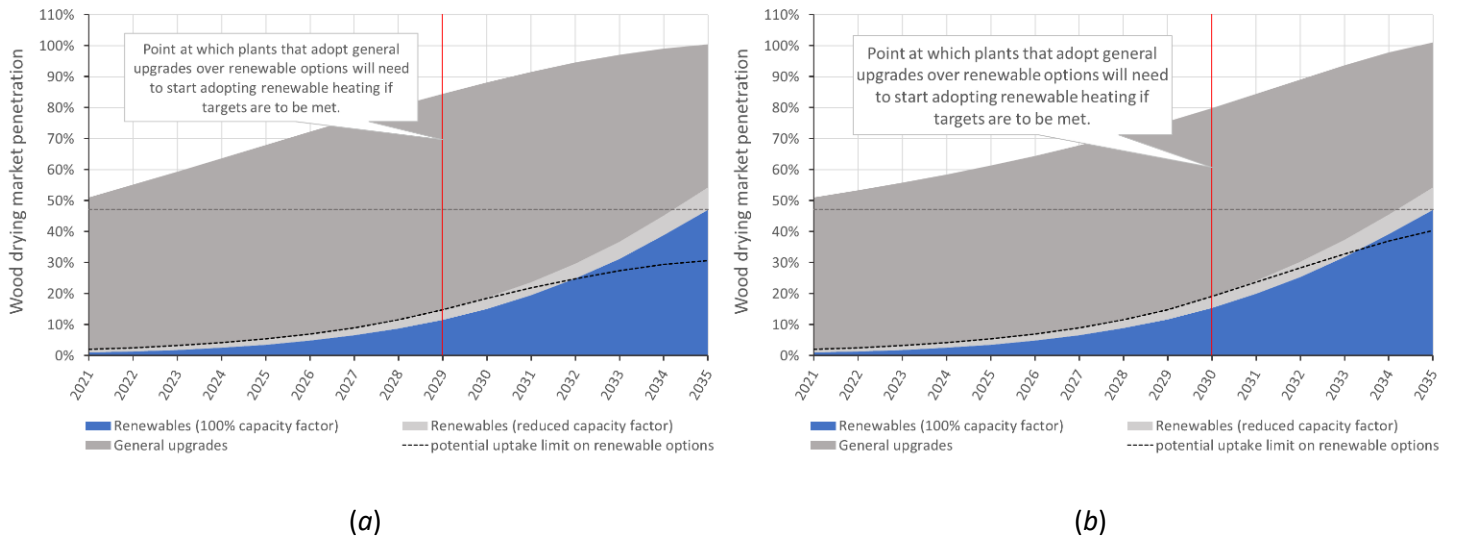

Figure 68. Projected market penetration of fossil fuel displacing investment options within the timber drying sector: (a) market penetration based on expected uptake rates for <100% renewable investment options. (b) effect of limiting investment in <100% renewable investment options.

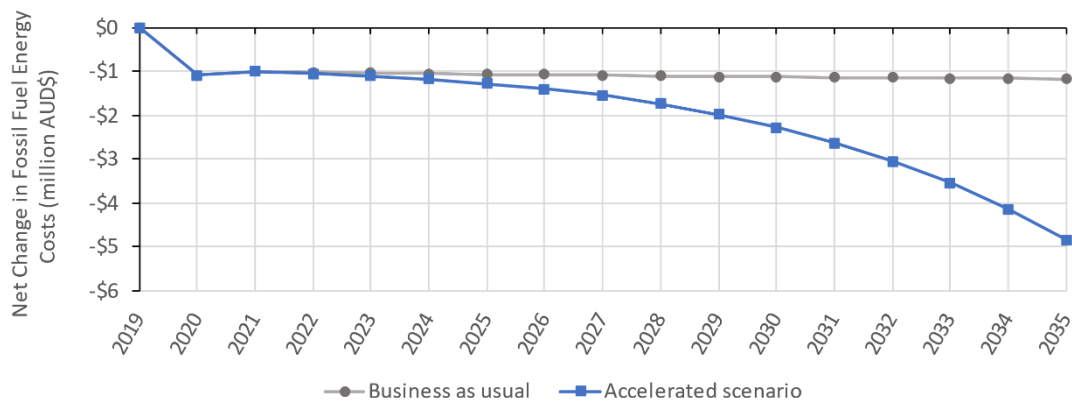

Figure 69. Net change in fossil fuel energy cost for Australian timber drying relative to 2019 levels.



### 4.3.3 Pulp and paper

#### Market potential at a glance

- As of 2020, the pulp and paper sector currently consumes 37.3 PJ of energy per year
  - Of this amount 21.2 PJ is for thermal processes for all temperature ranges, and 20 PJ for  $\leq 150$  °C. Note that a significant portion of heat ( $\approx 70\%$ ) is initially delivered at  $>250$  °C, however  $\approx 90\%$  of this high temperature thermal energy is delivered to CHP plants. The temperature of thermal energy delivered from CHP plants to processes is  $\leq 150$  °C.
  - Process heat for  $\leq 150$  °C contributes 733 kilotonnes CO<sub>2,eq</sub> per annum
  - The fossil fuel usage for this process heat costs approximately \$120 million per annum
  - If no new renewables technologies are taken up, the energy demand for this process heat is expected to increase at 0.88% per annum
- Based on a logistic technology uptake model, by 2035:
  - Under the BaU scenario, the emissions for process heat  $\leq 150$  °C would be 505 kilotonnes CO<sub>2,eq</sub> per annum. This is a reduction in emissions by 31% compared to 2019 levels. This reduction is primarily due to an energy from waste (EfW) project planned for completion in 2024 that is expected to reduce natural gas usage by 4 PJ per year.
  - Under the Accelerated Scenario, the emissions for process heat  $\leq 150$  °C would be 366 kilotonnes CO<sub>2,eq</sub> per annum. This is a reduction in emissions by 28% compared to the BaU scenario
  - Under the ACL scenario, the cost of fossil fuel consumption will be reduced by \$23 million relative to BaU
- One additional project prior to 2035 with a similar impact to the planned Maryvale EfW plant would allow the industry to achieve the 50% emissions target for 2035. In the absence of such a project, uptake rates for renewable heat technologies would need to accelerate by a factor of 3.9 relative to BaU.

#### 4.3.3.1 Introduction

The RACE for 2030 B3 Market Status Report indicates that demand for process heat within the pulp and paper industry in Australia occurs primarily within the kraft chemical pulping process. This process accounts for approximately 70% of the total heat demand within the industry, with the remaining 30% being consumed in the paper manufacturing process, primarily for drying. Heat for paper drying is supplied at between 145°C and 175°C. Apart from the heat used in the lime kiln, heat for the kraft pulping process is generally supplied at 350-400 °C. However, this heat is delivered throughout the process in a cascading manner, being used first for electricity generation in a CHP plant then distributed in the form of medium to low pressure steam at temperatures between 160 °C and 260 °C.

#### 4.3.3.2 Renewable energy technologies for heating demand in pulp processing

Before considering potential alternative heat supply sources for the individual stages of the kraft pulping process that only require heat below 150 °C, it is worth considering the heat flow through the entire process. Many of the process stages take place in complex equipment that has been designed

around the delivery of heat in the form of steam [225, 226]. While it may be possible to redesign this equipment to utilise heat delivered in a different form, this would be a significant undertaking and would likely only be relevant to greenfield developments. Additionally, plant layouts are also designed around this heat distribution method, and thus installation of multiple distributed heat supply technologies to match specific process stages may involve significant integration challenges.

Another consideration is that there is a significant amount of energy available in the waste product (Black liquor) produced by the pulping process itself, as well as in the waste products from the processing of the wood chips used as a feedstock. Both waste streams are a form of biomass and can hence be considered a net-zero emissions fuel. Both fuel sources are also already used extensively, supplying between 60% and 90% of the total energy requirements depending on the mix of black liquor and biomass available. Indeed modern pulp mills are capable of being entirely energy self-sufficient, and even producing a surplus of energy [227]. The lifespan of existing equipment however means that uptake of modern technologies is slow. Figure 70 shows the high-level energy supply and demand for the Kraft pulping process. Typically, these biomass sources are supplemented with natural gas and used to supply a CHP plant to provide both the electrical and process heat requirements for the pulping plant. It can also be seen in Figure 70 however, that if the heat and electricity supplies were decoupled from one another, the heat available from just the biomass fuels would, in most cases, be sufficient to cover the heating demands, without the need to redesign the heat distribution system. This would of course require that electricity be sourced from an alternative supply, however from a decarbonisation perspective, this theoretical approach demonstrates the potential of the biomass sources already being utilised.

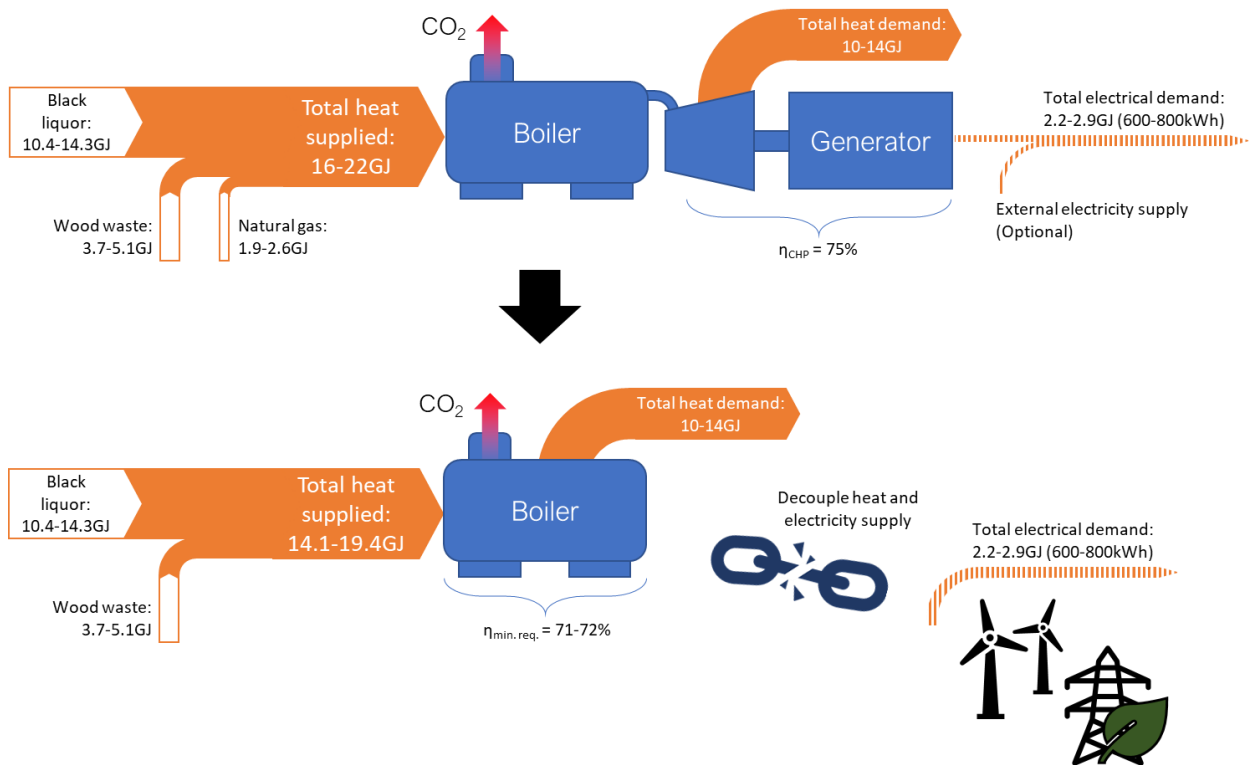

Figure 70. Energy supply and demand for the kraft chemical pulping process and the potential for decarbonisation of process heat through decoupling heat and electrical energy supply.

While removing natural gas from the mix of fuels supplying pulping plants (and making up any resulting shortfall in electrical energy supply from alternative, renewable sources) may be the simplest theoretical approach to decarbonising the pulp industry, there are also several stages of the pulping process with potential for energy savings. These are shown in Figure 71 and include all the process stages that are currently supplied by low pressure steam from the CHP plant. Opportunities 1 and 2 in Figure 71 could feasibly utilise ambient air as a heat source for a heat pump while maintaining a COP between 3 and 4. The bleach towers are designed around the use of steam as a heat delivery method [228], however the pulp drying process could easily replace this with an alternative heat transfer medium if required. The multi-effect evaporator (opportunity 3) requires a higher temperature than the other two. Based on the summary of high temperature heat pumps given in the RACE for 2030 technology review, this would require a heat source for the heat pump well above ambient temperatures. The most appropriate waste heat stream that could be utilised for this purpose is the hot humid air exhausted from the direct contact evaporator. Based on the performance of similar humid air heat recovery systems trialled in paper making plants in Europe [229], it is estimated that approximately 20% of the heat required by the multi-effect evaporator could be recovered from this waste heat stream. The combined effect of introducing heat pumps into the heat supply for each of these low temperature processes is shown in Figure 71. The overall heat demand for the pulping process could be reduced from 10-14GJ to 4.6-6.1GJ per tonne of product. This would be accompanied by a corresponding increase in electrical demand, going from 2.2-2.9GJ up to 3.8-5.1GJ. With these additional measures, it should be possible for the heat available in the combined black liquor and wood waste fuels to cover both the heating and electrical demands for the process. An alternative to heat pumps for these same processes would be solar thermal collectors, with flat plate or evacuated tube collectors easily being able to supply the range of temperatures required [2]. Compared to the use of heat pumps, solar thermal collectors would reduce the same heating load without the increase in electrical demand, however the space requirements would be significantly greater, posing more of a challenge in regard to integration with existing plants.

An alternative solution already being explored by the industry in Australia is simply substituting the natural gas demand with gas sourced renewably. In the case of a planned joint venture between Australian paper and SUEZ [230], this would be from municipal waste via an energy from waste (EfW) plant. This has the added advantage of diverting waste from landfill; however, it is a solution that is also dependent on the relative locations of waste source and pulp plant (or combined pulp and paper in the case of the proposed project) being conducive to one another. It therefore may not be a suitable solution for every pulp mill in Australia.

Finally, even if no alternative heat sources or natural gas replacements are considered, modern advancements in the black liquor recovery process, including alternative recovery processes such as black liquor gasification, are capable of eliminating the need for natural gas and increasing the power and fuel generation potential to the point where the pulp mills could become key suppliers of renewable energy [227].

## Electrification & Renewables to Displace Fossil Fuel Process Heating

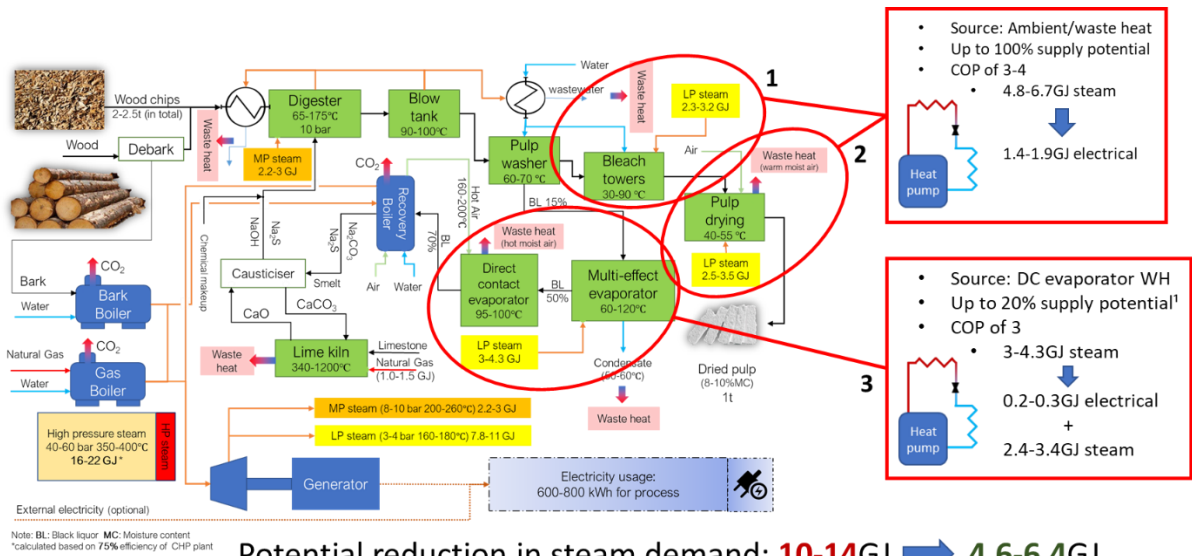

Potential reduction in steam demand: **10-14GJ** → **4.6-6.4GJ**

Corresponding increase in electrical demand: **2.2-2.9GJ** → **3.8-5.1GJ**

Figure 71. Opportunities for reduction in steam demand within the Kraft chemical pulping process. <sup>1</sup>Based on performance of similar heat recovery system trialled in paper manufacturing process [229].

### 4.3.3.3 Renewable energy technologies for heating demand in paper manufacturing

The heat demand from the paper manufacturing sector accounts for around 30% of the overall heat demand for the pulp and paper industry. Nearly all this heat is consumed in the pressing and drying stages of the paper manufacturing process, with a small amount also being used for the stock preparation stage. Heat is typically supplied by a steam boiler fuelled by natural gas. Like with the pulping process, the equipment used in paper drying is complex and has been design around the use of steam as the heat transfer medium. This indicates a low potential for steam (and the losses often associated with steam boilers and distribution networks) to be eliminated from the process, as this would require significant redesign of existing machinery. It is estimated that some improvement (around 15% of total energy demand) could be obtained in some cases by upgrading to best practice equipment/processes for the wet stage [226]. This report however will focus on opportunities for heat recovery in the drying stage and alternative methods of steam generation to the natural gas boilers currently used e.g. solar thermal steam generation or biogas.

Figure 72 summarises the opportunities for additional heat recovery within the paper manufacturing process. Any heat contained within the steam condensate is mostly recovered already and returned to the boiler inlet. Most of the heat used for drying however is carried away in the exhaust air from the dryer hood. Some of this heat is recovered for pre-heating the inlet air, and in some cases for building space or hot water heating, however between 40% and 60% of the heat contained in the exhaust is generally still available for recovery. The typical dew point of the air exiting the dryer hood is around 60-64°C, meaning that a high temperature heat pump could be utilised to recover a substantial amount of latent heat from the moist air and boost it back to the temperature and pressure delivered by the boiler. Systems have already been demonstrated that are capable of reducing total steam demand by around 20% using this approach [229].

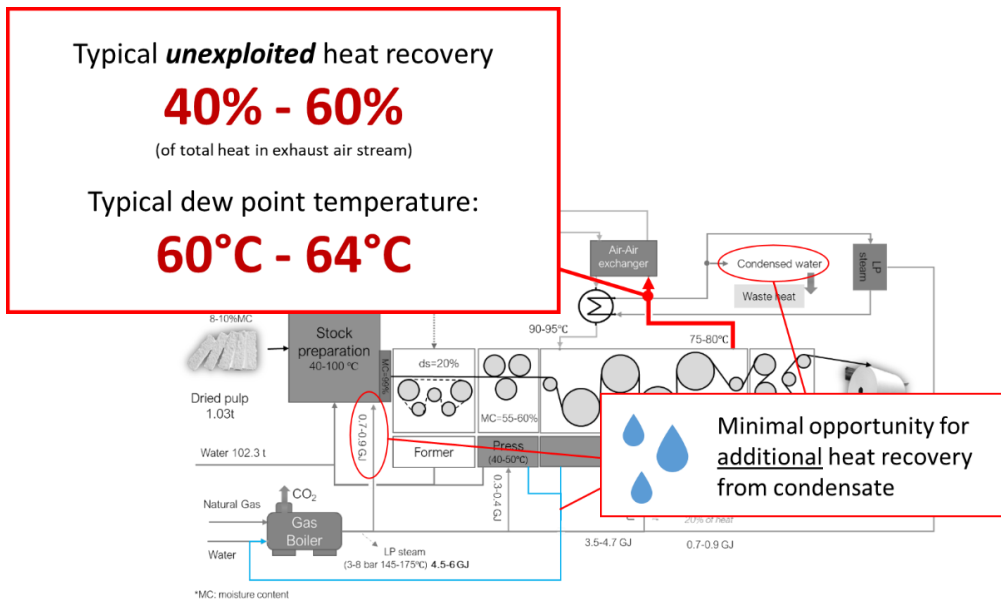

Figure 72. Opportunities for heat recovery in the paper manufacturing process.

Due to the reduction in dew point temperature as humidity decreases (i.e. as latent heat is recovered by condensing moisture from the air) the potential for complete heat recovery is low. Therefore, in order to achieve complete decarbonisation of process heat in paper manufacturing, an alternative heat supply will also be required to replace the remaining heat demand currently met with natural gas. This could be provided relatively easily by onsite solar thermal collectors or alternatively, off-site waste gasification. Another promising solution is to generate biogas within on-site anaerobic wastewater treatment plants [226, 231, 232]. This solution has the added benefit of reducing the pollutant emissions to water as well as the equivalent CO<sub>2</sub> emissions from process heat supply.

#### 4.3.3.4 Uptake scenarios: Pulp and paper

Unlike the uptake modelling for the wood drying sector, there are few options for decarbonisation of process heat within the pulp and paper industry that are both partial decarbonisation measures and prohibitive of continuing to a complete decarbonisation solution. Hence only the uptake of renewable process heat technologies with a capacity factor of 100% are considered for this sector.

As shown in Sections 4.3.3.2 and 4.3.3.3, the heat use by the paper sector can be assumed to be entirely below 150 °C. Additionally, any investment substantial enough to eliminate emissions from process heat below 150 °C in the pulp sector would effectively decarbonise the entire range of process heat temperatures by freeing up capacity from existing biomass sources to cover the higher temperature range. Therefore, decarbonisation of this temperature range will effectively result in complete decarbonisation of the process heat for the entire industry.

There is at least one major decarbonisation project, an energy from waste (EfW) plant, planned for completion in 2024. The development will be a partnership between SUEZ and Australian paper and is expected to eliminate approximately 4PJ per year of demand for natural gas by the Maryvale pulp and paper plant in Victoria [230].

It is assumed for the purpose of this report that the plant will deliver on these figures, and that the full impact of its completion will be reached after two years of operation (i.e. by 2026). It is assumed that under business-as-usual conditions, similar developments at other locations will not be

## Electrification & Renewables to Displace Fossil Fuel Process Heating

considered until the performance of this development has been evaluated. Hence it is likely that in this scenario, this will represent the only major reduction in emissions for the sector.

The expected growth in energy demand of 0.88% for the pulp and paper industry has been calculated in a similar manner as for the wood and wood products industry. The BAU scenario shown in Figure 73, specifically the assumption that the Maryvale EfW project will be the only such development in operation by 2035 is a relatively conservative scenario. This is reinforced by the accelerated scenario also shown in Figure 73, which effectively indicates that one additional project with a similar impact to the Maryvale EfW plant would be sufficient to reach the 2035 emissions reduction target. Given that the pulp sector accounts for approximately 70% of the heat use for the industry as a whole and considering the expected impact of the Maryvale EfW plant and the potential of the alternative decarbonisation options presented in Section 4.3.3.2, complete decarbonisation of the pulp sector should be achievable before 2035. In order to decarbonise the remaining 30% of heat used by the paper manufacturing sector however, additional development of the solutions and areas of research highlighted in Section 4.3.3.3 will be required.

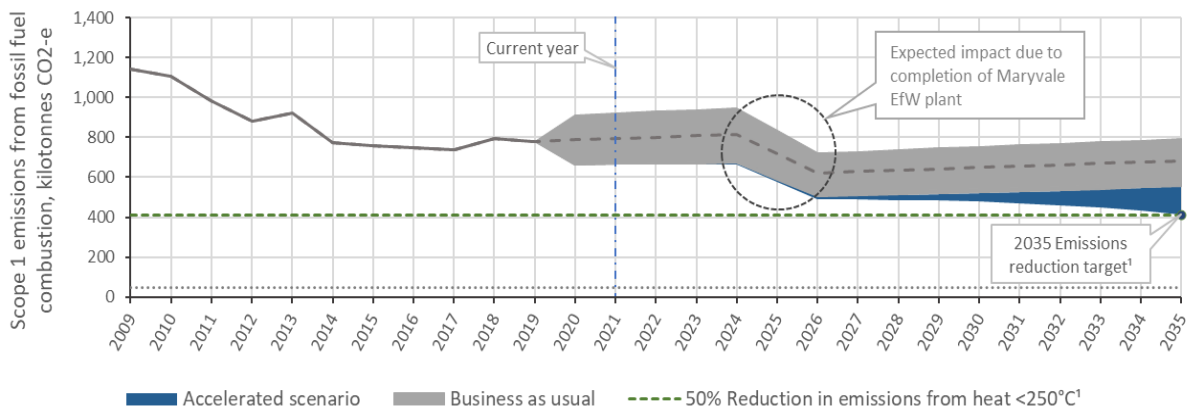

Figure 73. Projection of BaU and accelerated reduction in scope 1 equivalent CO<sub>2</sub> emissions for the pulp and paper industry, including the expected impact of a major EfW project planned for completion in 2024 [230].

<sup>1</sup> 2035 emissions reduction target assumes that decarbonisation of process heat below 150 °C will effectively decarbonise the entire range of temperatures for process heat and therefore represents a 50% reduction in scope 1 emissions for the entire industry, calculated with respect to 2019 levels.

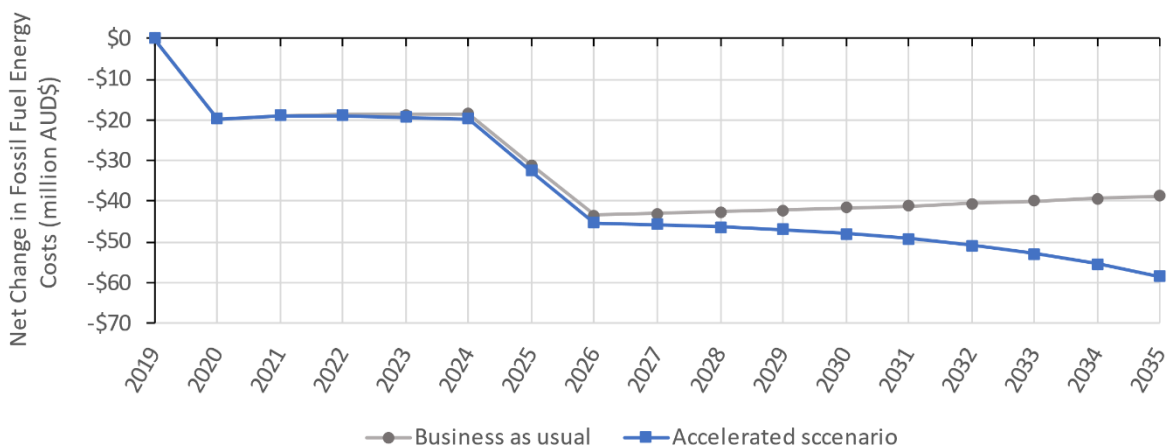

Figure 74. Net change in fossil fuel energy cost for Australian pulp and paper industry relative to 2019 levels.

Figure 74 shows the estimated net change in annual fossil fuel energy cost for the Australian pulp and paper industry. The results show that by 2035, a net saving of approximately 59 million AUD per annum can be released under the accelerated scenario relative to 2019 levels. Importantly, under the business-as-usual scenario, the annual fossil fuel energy use is already expected to decrease notably beyond 2019 levels, corresponding to a saving of 39 million AUD per annum by 2035. Therefore, the accelerated scenario will result in a saving of approximately 20 million AUD per annum relative to the BaU scenario.

### *4.3.4 Additional manufacturing and processing industries*

While the industries in Sections 4.3.1 to 4.3.3 represent the bulk of the process heat consumption below 150 °C for the manufacturing and processing sector, the remaining industries should not be overlooked. While these industries have not been examined in detail here, some rough projections based on the results in the above sections have been included. These show the combined potential for emissions reductions embodied by the remaining industries in this sector – the key difference to realising this potential being that it is spread between a greater number of industries and will therefore likely require a greater degree of effort to achieve.

#### *4.3.4.1 Non-ferrous metals excluding alumina*

While the low temperature process heat requirements of the non-ferrous metals sector (including alumina refining) extend from the very upper end of the temperature bracket considered by this opportunity assessment (100-150 °C) up to around 250 °C, the sector was included in this analysis due to the sheer amount of heat consumed. Assuming that 50% of the total heat consumption within the non-ferrous metals sector is between 150 °C and 250 °C [2] and taking into account the proportion of heat consumption in this range within the alumina refining process, it could be assumed that the amount of heat in this range for the remaining non-ferrous metals industries is approximately 37% of the total heat consumption. If the factors driving the accelerated emissions reductions in the alumina refining process are assumed to have a similar impact on the rest of the non-ferrous sector, it would result in approximately 885 kilotonnes of additional CO<sub>2,eq</sub> emissions reductions and a corresponding saving of 117 million AUD in fossil fuel costs with respect to 2019 levels by 2035.

#### *4.3.4.2 Other manufacturing and processing.*

It can be assumed that of the total process heat consumed by the remaining manufacturing and processing industries not examined in detail in this opportunity assessment, approximately 17% is below 150 °C [2]. Assuming similar renewable process heat technology uptakes can be achieved in these industries as for those in the wood, pulp and paper industries under the accelerated scenario, a total reduction of 266 kilotonnes CO<sub>2,eq</sub> could be expected relative to 2019 levels by 2035. This would correspond to a saving in fossil fuel costs of approximately 42 million AUD.

## 4.4 Food and Agriculture

### 4.4.1 Dairy Processing

#### Market potential at a glance

- Between 2019 to 2020, the dairy processing section in Australia consumed 8.96 PJ of energy
  - Of this amount, 7.53 PJ (84%) was for process heating, with all of this heating  $\lesssim$  150 °C
  - These processes contributed 391.2 kilotonnes of CO<sub>2,eq</sub> (per annum)
  - The cost of fossil fuels usage for process heating  $\lesssim$  150 °C is estimated to be \$93 million per annum
  - Milk powder production itself utilised 1.54 PJ per annum of energy for process heating, contributing 79.8 kilotonnes CO<sub>2,eq</sub> (per annum)
- Based on a logistic model, by 2035, for the dairy processing sector:
  - Under the BaU scenario, the emission reduction would be 24.4 kilotonnes CO<sub>2,eq</sub> per annum relative to the no uptake scenario;
  - Under the ACL scenario, the emission reduction would be 171.1 kilotonnes CO<sub>2,eq</sub> per annum relative to the BaU scenario;
  - To achieve the 50% emissions target by 2035, the uptake rate of renewable technologies needs to be increased by a factor of 4.4 compared to the BaU scenario;
  - The ACL scenario will potentially save \$41 million per annum in fossil fuel costs relative to the BaU scenario

#### 4.4.1.1 Introduction

Australian milk production was 8784 million litres in 2019-20 with a value of 4.8 billion AUD, with a very minor change predicted by Dairy Australia for 2020-21 [233]. From the Market Status Report, dairy processing utilises on average 1.02 GJ per kL of raw milk, with 84% of this due to process heating under 150 °C. It is estimated that this resulted in 391 kilotonnes of CO<sub>2,eq</sub> emissions per annum.

More than a third of the production was used to make milk powder [234]. The annual milk powder production since 2014-15 is presented in Figure 75, descending greatly from approximately 339 kilotonnes in 2014-15 to 185 kilotonnes in 2019-20. However, since there is a high demanding of milk powder from overseas countries, with this demand expected to grow in the future [235], for the purposes of this report it is assumed that this growth in milk powder consumption will balance the decline in demand of other milk products, and hence the milk production will keep to the 2019-20 level.



## Electrification & Renewables to Displace Fossil Fuel Process Heating

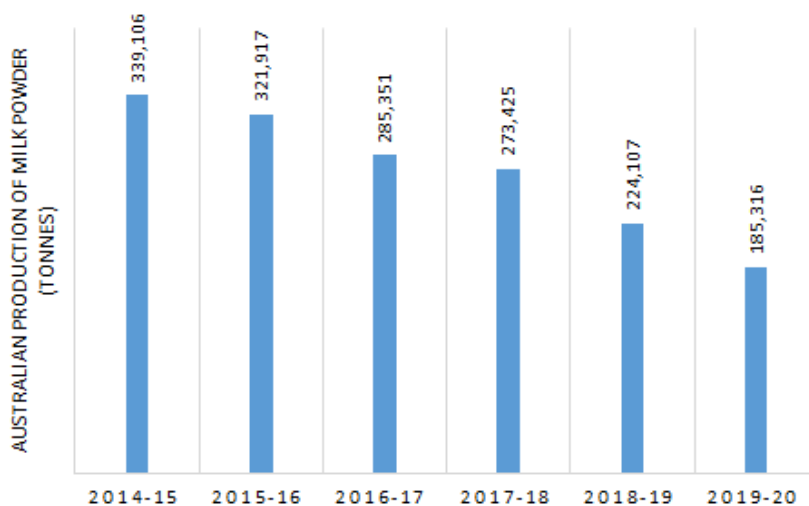

Figure 75. Australian production of milk powder [233].

Milk powder production is very energy intensive and most of the processing energy is used for heating in pasteurization, pre-evaporation, spray drying, and other value-added products. A flow diagram in Figure 23 presents the four forementioned processes and the temperature and energy required for each process (Market Status Report). More than 90% of the process heat is supplied by natural gas (NG) and the liquefied petroleum gas (LPG) or other fossil fuels provide the rest. Medium pressure steam of 160 °C – 210 °C is generated by using central boilers and distributed to the end process where heat is required through the steam reticulation system. The end processes, such as pasteurization, pre-evaporation and producing other value-added products, need much lower temperature (below 120 °C). Under full load operation, the central steam system only delivers the steam at an efficiency of 55% due to the large heat losses. The efficiency could reduce to 35% under part-load operation [236].

The pressure to improve energy efficiency has risen in recent years due to steep cost increase in gas and electricity. The energy used to produce 1 tonne of milk powder has been reduced from 12 GJ to 5-6 GJ in world-leading facilities. However, a slightly higher energy ( $\approx 8.3$  GJ) is required to produce the same amount in Australia and the energy breakdown in different processes is presented in Figure 23. To maintain the milk powder production at 2019-20 level (185 kilotonnes), a total energy of 1.54 PJ will be consumed, releasing about 79.8 kilotonnes of GHG emissions per annum when assuming the fuel mix of 95% NG and 5% LPG.

### 4.4.1.2 Renewable energy technologies for heating demand in the dairy industry

The application of a green fuel consistent with the hierarchy of renewable energy presented in the Technology Review can be assumed to provide the remaining heat needed to achieve 100% decarbonisation.

Table 28 provides a summary of options for each process along with the annual energy used for each process. The configuration of dairy processing facilities is to have a centralised boiler which can produce temperatures more than 250 °C. As a result, it is convenient to deliver all heating needs in a downward cascading approach, returning the condensate at near ambient temperature. The central boilers with steam reticulation system could be replaced with point of end use alternatives, such as biogas/biomass/electric boilers or heat pumps. By doing so, a considerable energy saving could be

achieved through reducing line losses. Other benefits include improving system reliability, and reducing maintenance cost and water consumption [236].

Immediate efficiency gains can be achieved by using mechanical vapour recompression (MVR) and thermal vapour recompression (TVR) in pre-evaporation process with the overall COP as high as 30-50 [234]. Recently, a reverse osmosis membrane technology was introduced to increase the solid content from 10% to about 30% before pasteurization of milk and hence reduced the energy demand in both pasteurization and pre-evaporation [234].

Current heat pumps are able to supply steam or hot water up to 160 °C, or hot air up to 120 °C with a moderate COP of 2-5 (Technology Overview Report). Future technology could improve the performance and increase the supply temperature up to 200 °C [234]. The Beyond Zero Emissions report lists the highly potential technologies that could contribute to the energy efficiency improvement and/or electrification in milk powder production. Heat pumps and MVR are limited to temperatures up to 180 °C and therefore cannot meet all the load. Furthermore, the COP of heat pumps are ultimately defined by the heat source temperature which is the condensate temperature of 30 °C or the exhaust air temperature from spray drying at 75 °C. This limits the effectiveness of these technologies at achieving the higher temperatures in these processes. Therefore, optimal techno-economic solutions combining heat pumps and MVR require investigation.

A unique characteristic of CO<sub>2</sub> heat pumps is the ability to conduct both refrigeration and steam production in a single stage of compression, minimising CAPEX. Furthermore, the outlet temperature from the heating side has no impact on the COP, as with sub-critical heat pumps, but rather the COP is maximised with a lower inlet temperature. Consequently, it may be possible to deliver refrigeration and effectively 'free' steam, with the same CAPEX for this technology.

The temperature limitation of HP/MVR can be overcome through electric boilers operating to provide top up steam, at very low CAPEX. However, these electric boilers will be limited by on-site electrical infrastructure. Furthermore, should grid electricity be required, peak electrical loads will require major transformer upgrades which are a significant cost.

Solar thermal can deliver sufficient high temperature steam for all processes efficiently, and therefore could meet the higher temperature load for spray drying. The footprint would be similar to any on-site solar PV facility driving a HP/MVR configuration, however much smaller than a similar solar PV facility driving an electric boiler. An inherent disadvantage is the reliance on high solar irradiance to deliver high temperatures. Solar PV electricity can deliver any temperature heat for the same efficiency. Therefore, site specific analysis is required.

The application of energy storage is critical for meeting nighttime heating demands. This inevitably requires increased on-site renewable energy capacity. As opposed to a single central thermal storage system, there is advantage in having multiple thermal energy storage systems operating at different temperatures. This provides for efficiency gains, particularly if this store is used as a heat source for HP/MVR systems. For electric based systems, where a high COP is achieved with HP/MVR systems a centralised battery is probably most cost effective. Since electricity is ubiquitous and so long as electrical infrastructure does not change, using a centralised battery to operate a HP/MVR probably is the most cost-effective approach.

The biogas/biomass option is a direct fuel replacement option and can deliver heat through a centralised facility. This option is heavily dependent on the sourcing of the fuel from a waste stream

## Electrification & Renewables to Displace Fossil Fuel Process Heating

effectively a zero-cost input. For a dairy processing facility, it is not clear where a suitable waste stream can be identified as these facilities are some distance from the actual dairy farms where biomass exist.

No consideration has been given for complex hybrid solutions of combination of the previous options which could deliver significant techno-economic benefits. Solar thermal technology might be able to provide a reasonable amount of heat for spray drying coupled with electric boiler, in combination with HP/MVR conducting the remaining heat.

*Table 28. Technology options with the potential to electrify dairy process.*

Processes require heat	Spray drying	Value added products	Milk pasteurization	Pre-evaporation
<b>Heat demand</b>	65-210 °C, 3.7-5.8 GJ/t	70-110 °C, 0.2-1.3 GJ/t	80-120 °C, 0.9-1.4 GJ/t	65-73°C, 0.4-0.6 GJ/t
<b>Option 1</b>	Reuse waste heat and reduce the heat loss from steam reticulation system			
<b>Option 2</b>	Biogas/biomass boiler			
<b>Option 3</b>	electric boiler (EB) + renewable grid electricity (via PPA's)			
<b>Option 4</b>	Solar PV + EB + storage (thermal or battery)			
<b>Option 5</b>	Solar thermal			
<b>Option 6</b>	Solar thermal + thermal energy storage			
<b>Option 7</b>	-	Solar PV + heat pump (HP)/MVR		
<b>Option 8</b>	-	Solar PV + HP/MVR + storage		
<b>Option 9</b>	-	-	-	Use reverse osmosis to remove 20% of the water before evaporation.
<b>Example optimized option</b>	<b>Recover waste heat from fluidized bed drying, reduce heat loss</b>			
	PV + EB + storage	PV + HP + storage (decentralized system to minimize heat loss and optimize COP)		Use reverse osmosis to remove 20% of the water before evaporation using MVR-TVR

### 4.4.1.3 Uptake scenario: Milk powder production

The logistic growth function presented in Section 4.2 was adopted to simulate the market uptake of potential technology options (in Table 28) to replace the NG and LPG as dominant fuel sources. Each technology has its advantages and drawbacks and the decision on specific option selection is complex and needs to be analysed case by case. Theoretically, each new technology has its individual market adoption rate, however, determining the breakdown of technology is beyond the scope of this study. In this study, all the technology options are grouped as new technologies to decarbonize the heating process in the dairy sector. Hence, one uniform market penetration is used, and it aims to achieve 100% potential market penetration (the parameter K) ultimately. Some energy efficiency/saving technologies, such as electric boilers, heat pumps and solar PV, have been implemented and demonstrated in this industry. However, the market penetration is still minimal and a 1% value ( $P_0$ ) is assumed. In ACL scenario, the growth factor ( $r$ ) is adjusted to 0.317 to ensure that the GHG emission (scope 1) level is reduced to half by 2035 compared to 2020 level, as presented in Figure 76. The

## Electrification & Renewables to Displace Fossil Fuel Process Heating

historical information on new technology adoption rate is not available, therefore, a growth factor in BAU scenario is conservatively assumed to be 0.15. With this growth factor, it will take in excess of 60 years for 99% decarbonisation of process heat in the dairy sector. The parameters to generate the logistic growth function for the BAU and ACL scenarios are listed in Table 29. The overall new technology market penetration under the two scenarios is presented in Figure 77. Under the mild technology adoption in the BAU scenario, the scope 1 GHG emission reduction is minimal, at 5 kilotonnes in 2035 compared to the 2020 level (i.e. a 6.2% reduction). By contrast, the accelerated scenario will reduce emissions by 35 kilotonnes CO<sub>2,eq</sub> per annum relative to business as usual by 2035.

Table 29. Logistic function parameters for business-as-usual and accelerated scenarios for dairy processing

Uptake scenario model parameter		Business-as-usual	Accelerated Scenario
<b>Potential market penetration of alternative technologies</b>	K <sub>0</sub>	100%	100%
<b>Initial technology adoption level (as of 2021)</b>	P <sub>0</sub>	1%	1%
<b>Growth/uptake factor</b>	r	0.15	0.317

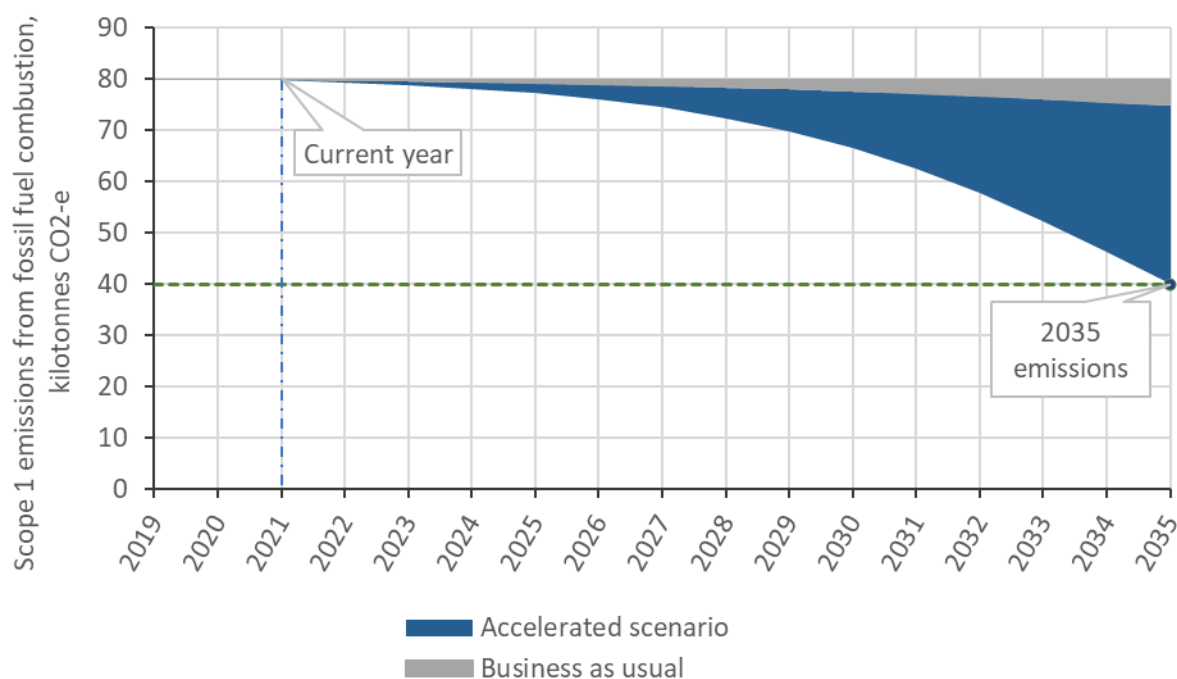

Figure 76: Projected scope 1 GHG emission reduction up to 2035 for milk powder production under BAU and ACL scenarios

### 4.4.1.4 Indicative result on entire dairy processing

It was reported in Market Status Report that on average, 1.02 GJ per kilolitre of raw milk is needed for producing various dairy products (including milk powder), with 84% of this energy demand due to process heating at temperatures  $\lesssim 150$  °C. This, in turn, is estimated to produce 391.4 kilotonnes of CO<sub>2,eq</sub> emissions per annum.

Figure 77 and Figure 78 show the results of the uptake modelling for the entire dairy processing sector, under the assumption that the modelling inputs, in particular the fuel mix and technology uptake

## Electrification & Renewables to Displace Fossil Fuel Process Heating

rates, are similar to that of milk powder production. The results show that under the BaU scenario, a modest reduction in annual emissions due to fossil fuel consumption of 24.4 kilotonnes CO<sub>2,eq</sub> can be expected by 2035. More significant reductions can be expected under the accelerated scenario, with a 171.1 kilotonnes CO<sub>2,eq</sub> per annum reduction expected by 2035.

Figure 79 shows the net change in annual fossil fuel energy costs for the dairy processing sector relative to 2019 levels. The results show that the BaU scenario will result in a modest savings of approximately 5.8 million AUD per year by 2035, while under the accelerated scenario, the savings will increase to approximately 46.5 AUD million (i.e. a reduction of 41 million AUD per annum relative to the BaU scenario).

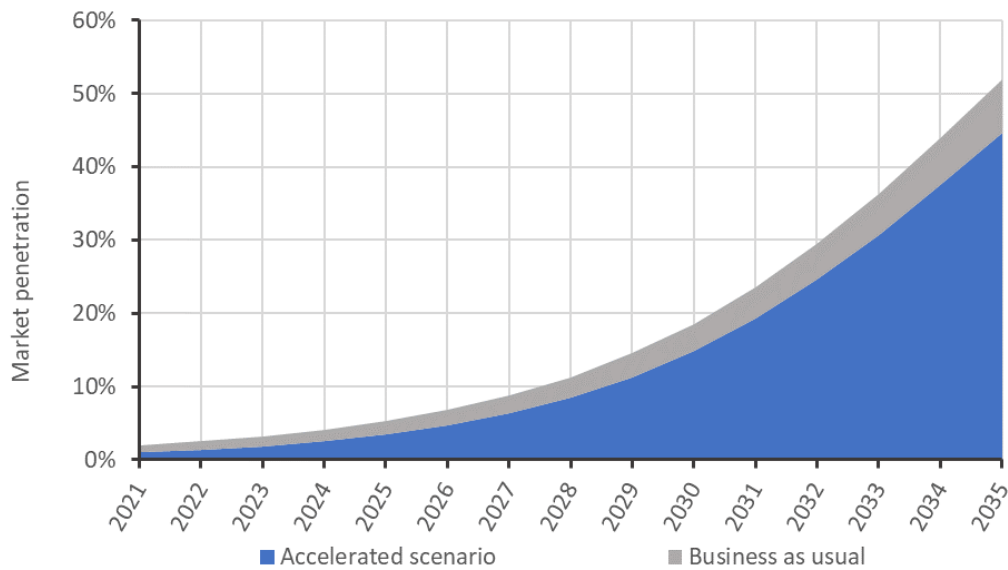

Figure 77: The overall new technology market penetration in dairy processing under BAU and ACL scenarios.

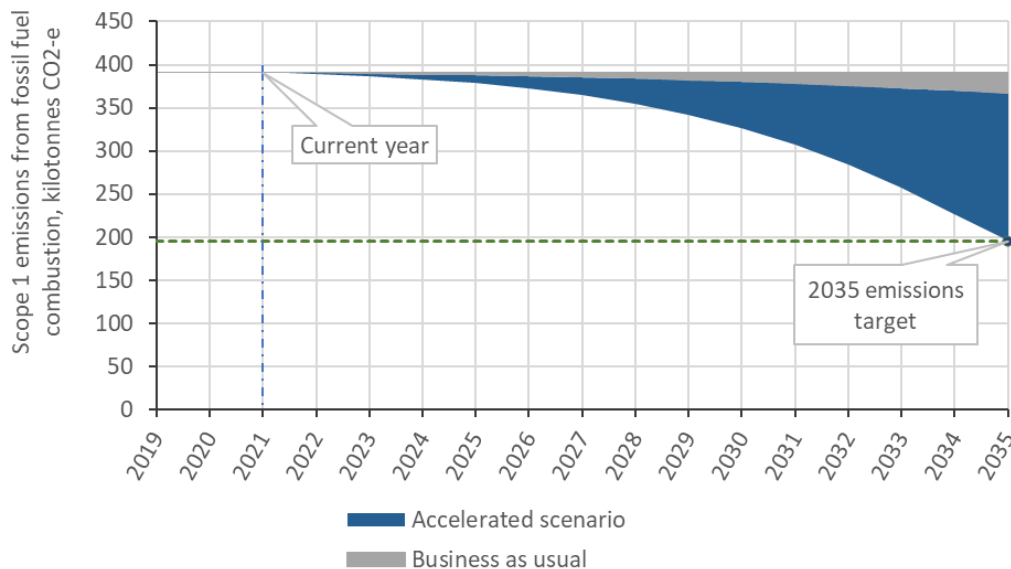

Figure 78: Projected scope 1 GHG emission reduction up to 2035 for overall dairy processing under BAU and ACL scenarios.

## Electrification & Renewables to Displace Fossil Fuel Process Heating

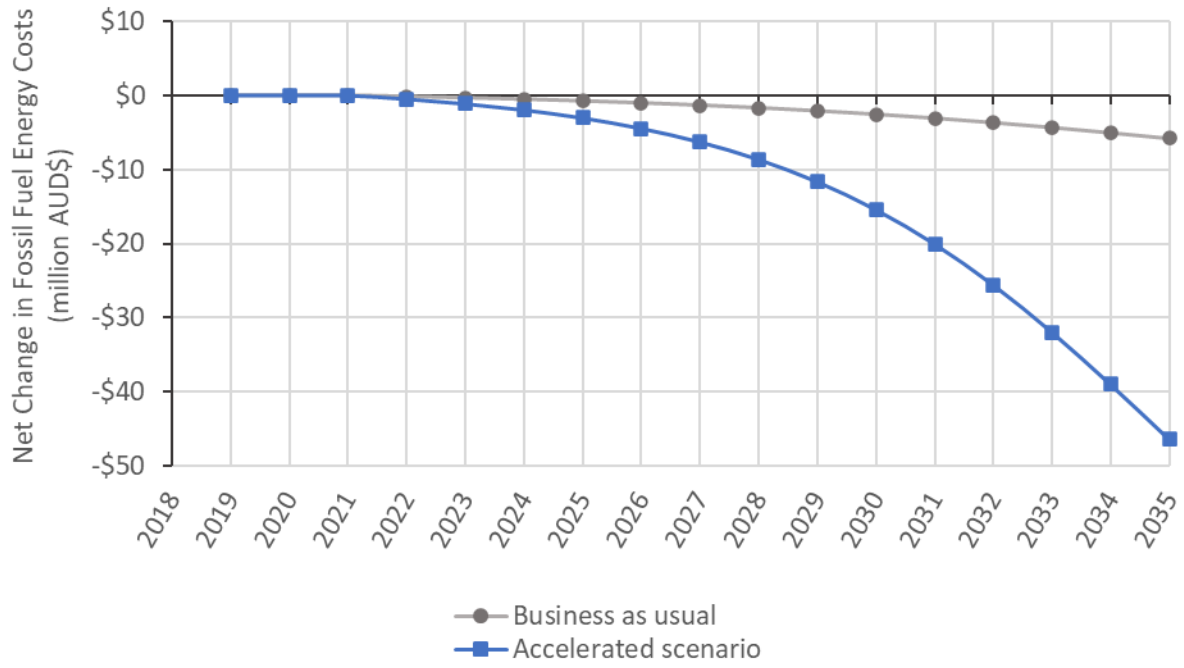

Figure 79: Net change in annual fossil fuel energy costs for the dairy processing sector relative to 2019 levels.

#### 4.4.2 Meat Processing

##### Market potential at a glance

- In 2019, the Australian meat processing sector consumed 7.48 PJ of energy for thermal processes <150 °C
  - This resulted in 452 kilotonnes of CO<sub>2,eq</sub> per annum of greenhouse gas emissions
  - The cost of fossil fuel consumption for this sector is approximately \$55 million per annum
  - The demand for energy is expected to grow at approximately 2% per year in the near future
- Based on a logistic model, by 2035:
  - Under the BaU scenario, the emissions will increase by 66.5 kilotonnes of CO<sub>2,eq</sub> per annum relative to 2019 levels
  - Under the accelerated scenario, emissions will reduce by 292.5 kilotonnes of CO<sub>2,eq</sub> per annum relative to BaU
  - To achieve the 50% emissions target by 2035, the uptake rate of renewable technologies needs to be increased by a factor of 3.5 compared to the BaU scenario;
  - Under the ACL scenario, fossil fuel consumption costs will be reduced by \$36 million per annum relative to the BaU scenario.

Australia's red meat and livestock industry contributed significantly to Gross Domestic Product (GDP), i.e. 17.6 billion AUD in 2018-19 equivalent to 1.4% of Australia's key industry GDP [237]. This industry employed 31,200 people in meat processing, which accounts for 17% of total full-time equivalent employment in the Agriculture, Forestry & Fishing sector [238]. Figure 80 below presents the amount of red meat production in Australia since 2000. Continuously growing from 2016, Australia's red meat production totalled 3.56 million tonnes Hot Standard Carcase Weight (HSCW) in 2019 [239].

Steam is the main source of heat in the meat processing. A typical process requires approximately 2.1 GJ of heat per tonnes of HSCW on average. Medium pressure steam at temperatures around 180 °C – 185 °C, generated by the central boilers, is used directly in rendering and blood processing, which demands most of heat (≈88%). The waste heat from exhausted steam in the rendering process is recovered and used to supply hot water (82 °C) and warm water (43 °C) for sterilization, slaughter, and evisceration processes. Almost 60-70% of energy needs for hot/warm water comes from the waste heat. Figure 25 provides the meat processing overview and summarizes the energy and temperature demand in each process.

## Electrification & Renewables to Displace Fossil Fuel Process Heating

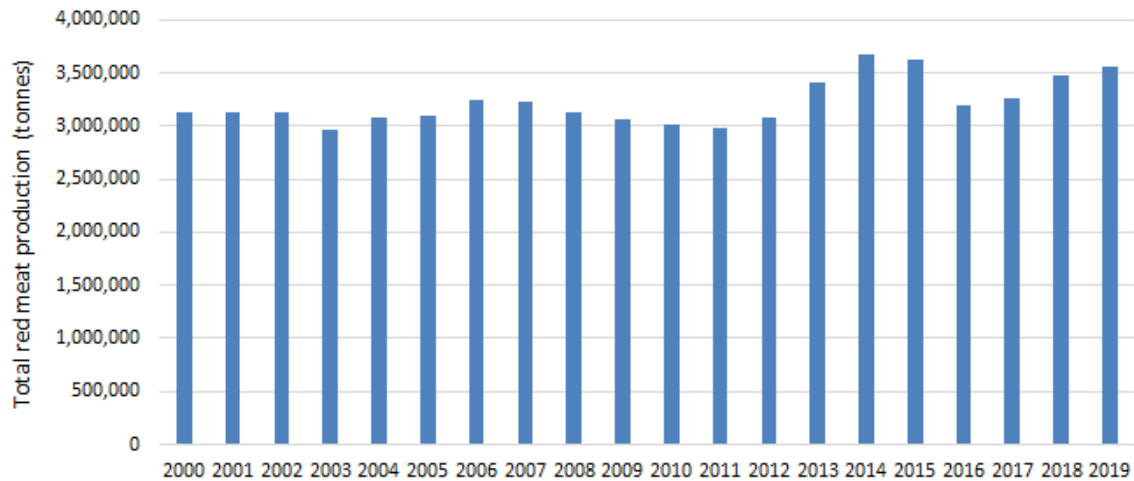

Figure 80: Australia's red meat production since 2000 [239].

The Australian Meat Processor Corporation (AMPC) and Meat & Livestock Australia (MLA) reviewed the energy use in 14 red meat processing facilities and reported a 27% reduction in energy usage for both process heat and refrigeration from 2008-09 to 2013-14 [240]. The energy efficiency improvement was mainly attributed to the use of biogas captured from wastewater treatment on site, which increased from zero in 2008-09 to 6.6% in 2013-14. The natural gas usage was reduced from 37% in 2008-09 to 30.2% in 2013-14, substituting by the biogas. Biogas is the by-product from wastewater treatment, though it consumes about 74 kg CO<sub>2</sub>-e per tonne of HSCW [240], it is not accounted in the scope of this calculation. However, the cost of biogas is assumed to be \$2/GJ, half the cost of that distributed in the pipeline, considering the cost of facility and operation. The other major energy source for steam production is coal. This work neglected the minor energy sources (e.g. LPG, biomass) and assumed that only natural gas, coal, and biogas are the boiler fuels for process heat, accounting for 54.5%, 35.1% and 10.4% after adjustment, respectively. This composition of energy sources is based on the latest report published by AMPC and Meat & Livestock Australia in March 2021. On average, the annual replacement rate of natural gas is approximately 1.0%. It is estimated that the GHG emission is 481.0 kilotonnes of CO<sub>2</sub>eq and the energy consumption for heat generation is 7.48 PJ based on the production in 2019.

### 4.4.2.1 Meat Processing Technology Options

Table 30 summarized the promising solutions to reduce energy consumption and/or applying renewable energy to deliver heat in meat processing. Overall, the technology opportunities are similar to that presented in Section 4.4.1 for dairy, apart from a variety of differences.

Maximum temperature needs are approximately 145 °C, which MVR/HP can achieve. Furthermore, solar thermal can readily achieve this steam need at higher efficiency than in the dairy application.

Freezer temperature refrigeration is needed in addition to cold room refrigeration. Therefore, the potential of combined heat and cooling with HP should be considered. However, with freezing needed, multi-stage HP is required which can reduce the value proposition.

Meat works produce a significant amount of biowaste, which can potentially be used to produce biogas from biodigestion [241]. Biogas production will minimize waste charges while delivering a fuel of value. It is unlikely that the biogas production will provide sufficient heat to meet all the load, but



## Electrification & Renewables to Displace Fossil Fuel Process Heating

it can reduce the use of fossil fuels. However, rather than relying on fossil fuels using HP/MVR or solar thermal technology to deliver 100% decarbonization should be considered.

Biogas burning and HP combined heating and cooling can be viewed as complementary technologies. HP can deliver the heating needs that biogas cannot, and vice versa. Furthermore, should gas grid biomethane injection prove viable in the future, this can be implemented through an expansion of HP or the application of solar thermal without stranding the biogas production facility.

Overall, combinations of technology are needed to be considered to deliver not only a commercially viable solution, but a technology strategy is needed for decarbonization over time.

Table 30: Technology options with the potential to electrify/decarbonate meat processing.

Processes require heat	Rendering and blood processing	Sterilization, slaughter & evisceration
<b>Heat demand</b>	Steam at 115-145°C, 1.6-2.1 GJ/t HSCW	Hot/warm water at 43-82°C, 0.2-0.3 GJ/t HSCW
<b>Option 1</b>	Produce biogas using wastewater on site + biogas boiler	
<b>Option 2</b>	Maximize waste heat recovery from rendering and reduce the heat loss from steam reticulation system	
<b>Option 3</b>	Recover waste heat from boilers and chillers to preheat boiler feed	
<b>Option 4</b>	Biomass boiler	
<b>Option 5</b>	EB/HP/MVR + renewable grid electricity (via PPA's)	
<b>Option 6</b>	Solar PV + EB/HP/MVR + storage (thermal or battery)	
<b>Option 7</b>	Solar thermal	
<b>Option 8</b>	Solar thermal + thermal energy storage	
<b>Example optimal option</b>	<b>Biogas generation on site + biogas boiler, reduce heat loss, recover waste heat to preheat water</b>	
	<b>PV + HP + storage (to meet the rest of demand if biogas is insufficient)</b>	<b>Recover waste heat from rendering process, PV + HP + storage (to meet the rest of heat demand)</b>

### 4.4.2.2 Meat Sector Market Uptake

Since the approach of generating biogas on site and substituting natural gas as boiler fuel is underway, it is considered as the BAU scenario and the average replacement rate of 1.0% per year (constant) is considered as the technology market penetration. The growth in energy demand, based on historical data, is estimated to be 2% per year. Biogas accounted for 10.4% of the total energy source for heat production in 2020 and it is used as the initial/current adoption level ( $P_0$ ) for both BAU and ACL scenario. The results are shown in Figure 81 and in Figure 82. The results show that to achieve a 50% reduction in emissions by 2035, the uptake rate of renewable process heat technologies needs to be increased from the current 1.1% per year (under the BaU scenario) to approximately 3.7% per year (a factor of 3.5 increase). The results also show that the annual emissions actually increase under the BaU scenario, because the growth in energy demand outpaces the uptake in renewable technologies. Under the BaU scenario, by 2035, the annual emission would increase to 578.3 kilotonnes of CO<sub>2eq</sub> per annum.

In 2035, the cost of fossil fuel consumption under the BaU scenario is estimated to be 66.5 million AUD per annum, while under the accelerated scenario, this reduces to 27.5 million AUD per annum. Figure 83 shows the net change in annual fossil fuel cost for both the BaU and accelerated scenarios. As can be seen, under the BaU case, the cost of fossil fuel consumption increases, because the growth

## Electrification & Renewables to Displace Fossil Fuel Process Heating

rate in demand outweighs the energy reduction due to renewable energy uptake. However, under the accelerated scenario, the reduction in fossil fuel costs decreases near-exponentially, and by 2035 a reduction of 36 million AUD per annum relative to the BaU case is estimated from the model.

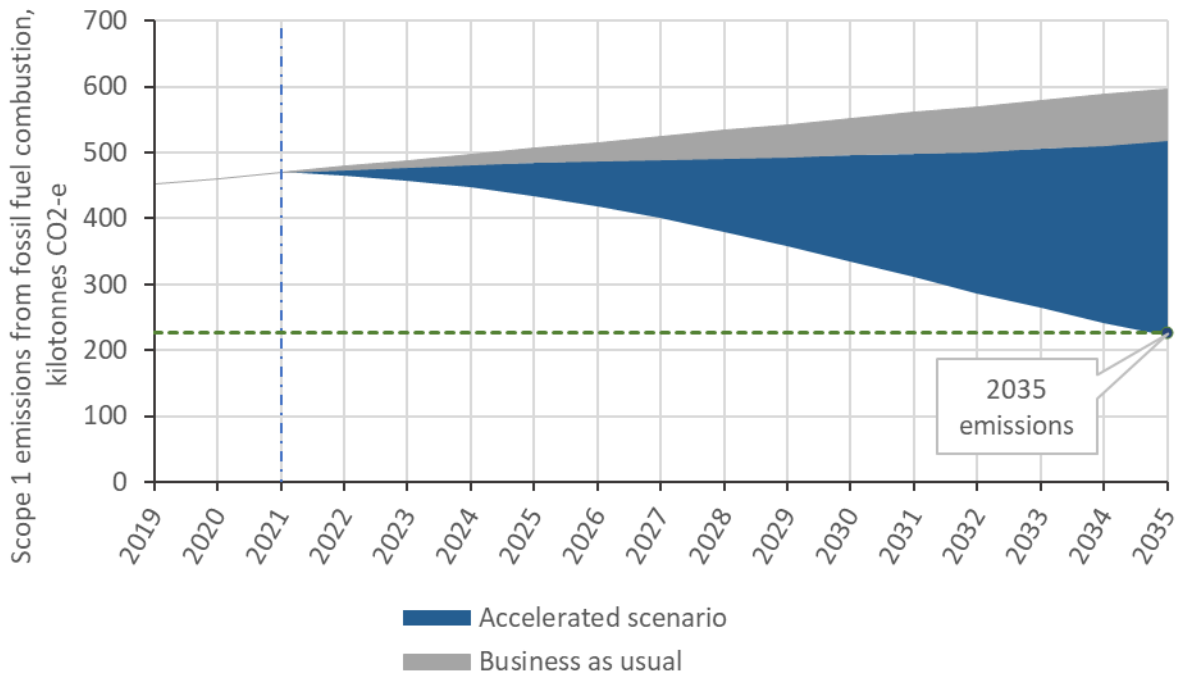

Figure 81: Projected scope 1 GHG emission reduction up to 2035 for meat processing under BAU and ACL scenarios.

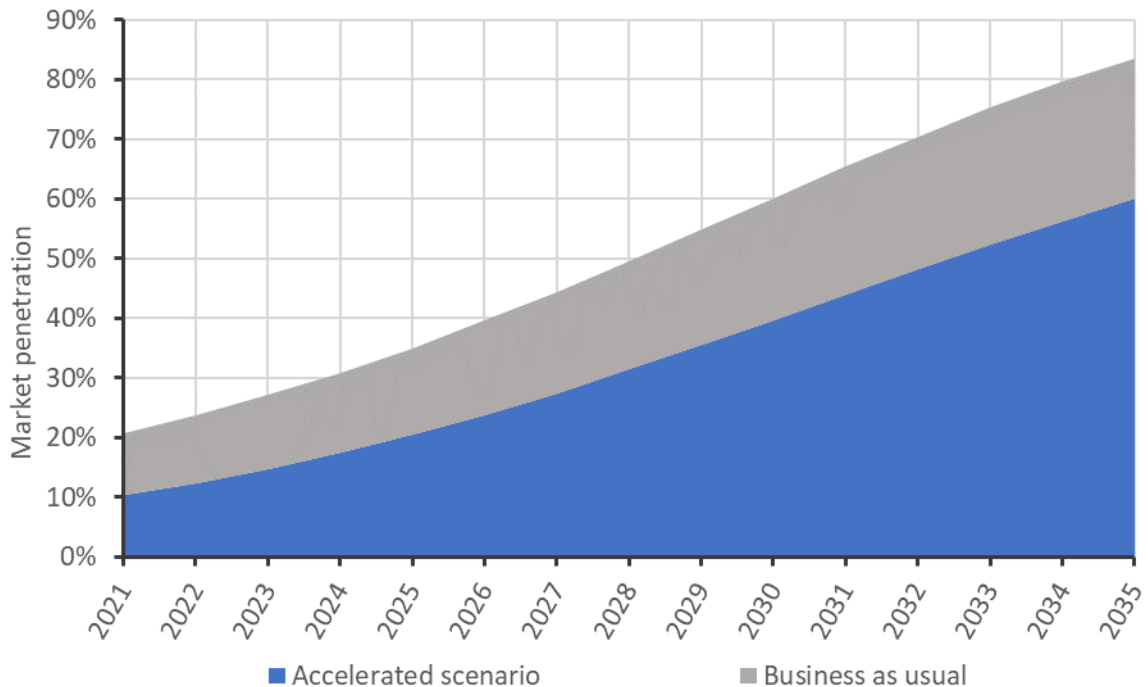

Figure 82: The overall new technology market penetration in meat processing under BAU and ACL scenarios.

### Electrification & Renewables to Displace Fossil Fuel Process Heating

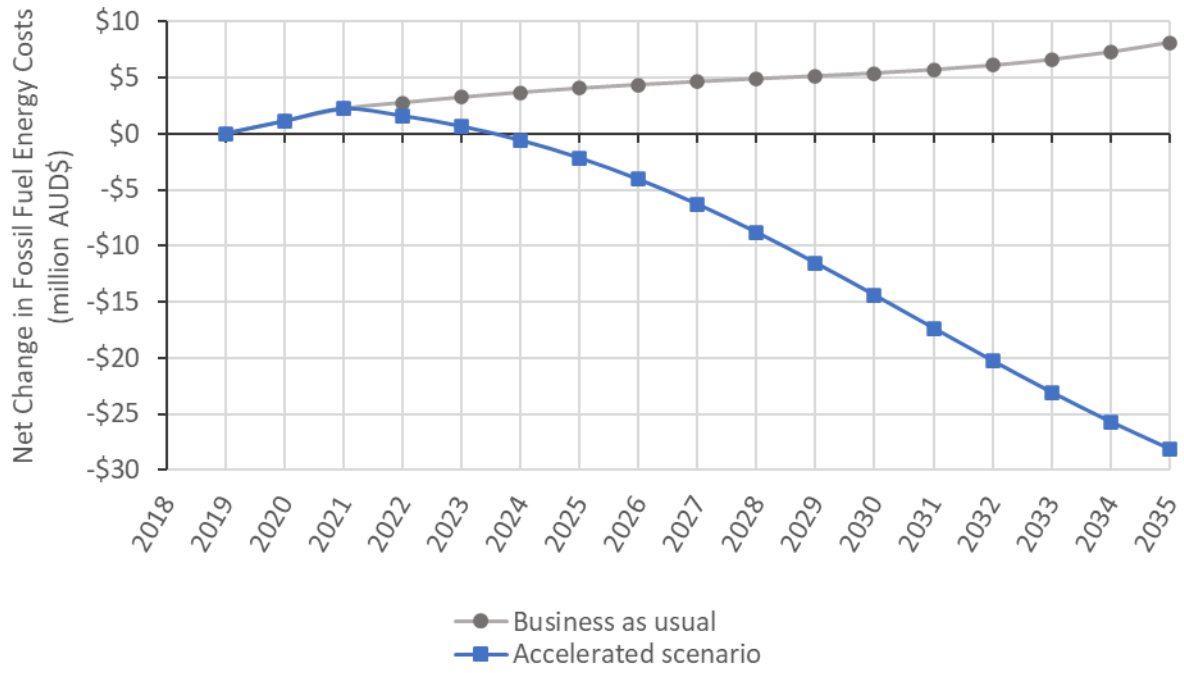

Figure 83: Net change in annual fossil fuel energy cost for the meat processing sector relative to 2019 levels

### 4.4.3 Beer Processing

#### Market potential at a glance

- In 2019, it is estimated that 1.52 PJ of thermal energy was consumed during beer production, with all of this energy used for process heat <150°C
  - This process heat for <150 °C contributed 78.5 kilotonnes of CO<sub>2,eq</sub> per annum
  - Fossil fuel energy costs for this process heat is estimated to be \$16.7 million per annum
- Based on a logistic model, by 2035:
  - Under the BaU scenario, the emission reduction would be 6.3 kilotonnes CO<sub>2,eq</sub> per annum relative to the 2019 levels;
  - Under the ACL scenario, the emission reduction would be 32.2 kilotonnes CO<sub>2,eq</sub> per annum relative to the BaU scenario;
  - Under the ACL scenario, fossil fuel energy costs will be reduced by \$7 million per annum relative to the BaU scenario
  - To achieve the 50% emissions target by 2035, the uptake rate of renewable technologies needs to be increased by a factor of 3.3 compared to the BAU scenario.

The annual industry revenue is approximately 4.3 billion AUD, and it is projected to have an annual growth of 4.2% from 2021 to 2026 [242]. In Australia, the total beer production in 2017-18 was 1342 million litres [243]. Over the last five years, the overall beer consumption has decreased by 0.7% [244] and it is forecasted to have a drop of 0.4% over four years due to the rising health awareness and higher taxes [245]. On the contrary, the craft beer consumption was anticipated to grow. In this study, it is assumed that the beer manufacturing in Australia will have a contraction rate of 0.1% per year.

Low pressure steam is the main source of heat in the beer processing. Steam at temperatures of 130-160 °C is generated in NG boilers and distributed to various processes where heat is required: grain mashing and lautering (45-75 °C), hop/wort boiling in the kettles (95-100 °C), whirlpool tank (40-80 °C), packaging and pasteurization (60-70 °C) and cleaning in place (70-90 °C). A considerable amount of energy results from the steam reticulation system. The production requires 83-144 MJ of energy per hectolitre of beer for breweries whose annual production volume is 10,000-1,000,000 hectolitres. It is estimated that the energy consumption for beer production in 2017-18 is 1.11-1.93 PJ (approximately 1.52 PJ on average). The energy/temperature required in the processes is presented in Figure 27.

#### 4.4.3.1 Beer Processing Technology Options

Breweries are very conscious of incorporating renewable energy or energy saving technologies into the brewing process. Victoria Bitter beer is now manufactured using 100% solar PV electricity in 2020, under Asahi Beverages' sustainability program which aims to power the entire beverages by 100% renewable electricity by 2025 [246]. At Coopers Brewery in Adelaide, a 4.4 MW natural gas-powered co-generation plant supplies 50,000 tonnes of steam per year and the hot water produced is used to kiln the malt, reducing gas usage by up to 40% [247]. Lion has a target to reduce carbon emissions by 30% by 2026 from 2015-year level [247]. Solar PV was also installed in many craft breweries, e.g. the Grove Distillery, Young Henry's, Helios Brewing (also installed evacuated tube solar thermal system) and Grand Ridge Brewery [248].

## Electrification & Renewables to Displace Fossil Fuel Process Heating

Technology solution issues are very similar to options discussed for the previous sectors and are listed in Table 31. In the beer industry, the opportunity favours HP technology. Due to maximum temperatures required being lower, around 160 °C with processes operating at lower temperature, and only chilling required, combined heating and cooling HP is an attractive option. However, this will depend on the matching of load requirements which could be overcome with thermal storage. Alternative options using MVR or solar thermal could also be used if load mismatching exists.

Production of biogas from biomass waste is worthy of investigation if excess heat is needed, however consideration should be given to biomethane gas grid injection should be considered. Similar to microwave technology used in dairy processes, experimental MW assisted configurations are possible but currently no commercially available microwave system exists.

Table 31: Technology options with the potential to electrify/decarbonate beer production.

Processes require heat	Hop boiling in kettle	CIP and other heating demand	Pasteurization and packaging	Mashing
<b>Heat demand</b>	Steam at 100 °C, 39.1-67.8 MJ/hL	Water at 70-90 °C, 16.6-28.8 MJ/hL	Water at 60-70 °C, 22.4-38.9 MJ/hL	Water at 45-75°C, 4.9-8.5 MJ/hL
<b>Option 1</b>	Produce biogas using wastewater on site + biogas boiler			
<b>Option 2</b>	Maximize waste heat recovery preheat water and reduce the heat loss from steam reticulation system			
<b>Option 3</b>	Biomass boiler			
<b>Option 4</b>	EB/HP/MVR + renewable grid electricity (via PPA's)			
<b>Option 5</b>	Solar PV + EB/HP/MVR storage (thermal or battery)			
<b>Option 6</b>	Solar thermal			
<b>Option 7</b>	Solar thermal + thermal energy storage			
<b>Example optimal option</b>	Biogas generation on site from wastewater + biogas boiler, reduce heat loss, recover waste heat to preheat water, PV + HP + storage to meet the rest of demand			

### 4.4.3.2 Beer Processing Market Uptake

According to the Market Status report, more than 90% of Australian beer is manufactured by major commercial breweries, and many of them already have ambitious renewable/sustainable target as aforementioned in the last section. To reduce the operating cost and increase business competitiveness, the craft breweries is following major breweries' step and has started adopting the renewable technologies, especially solar PV and solar thermal. Considering the market status, the initial/current adoption level in logistic growth function is assumed to be 20% in both BAU and ACL scenarios, with all non-renewable energy supplied by natural gas. It is anticipated that 50% of breweries will achieve 50% of GHG emission reduction by 2035 in BaU scenario and it is feasible if those breweries accomplish their targets. In ACL scenario, it is assumed that the beer sector will achieve 50% GHG emission reduction by 2035. Applying iteration procedure, the growth factor in logistic growth function is determined to be 0.075 and 0.14, respectively. The corresponding projected technology market penetration and trajectory GHG emission reduction in the next 15 years under BaU and ACL scenario are presented in Figure 84 and Figure 85, respectively. The results show that with the current assumptions, in 2019 the total emissions in the beer processing sector due to process heat is approximately 78.5 kilotonnes CO<sub>2eq</sub> per year. Under the BaU scenario, by 2035 the emissions will reduce by 6.3 kilotonnes CO<sub>2eq</sub> per year relative to 2019 levels, while under the accelerated scenario

## Electrification & Renewables to Displace Fossil Fuel Process Heating

the corresponding reduction will be 38.5 kilotonnes CO<sub>2eq</sub> per year. To achieve a 50% emission reduction by 2035, the rate of renewable energy uptake needs to be accelerated from the current ≈1.1% per year to ≈3.6% per year on average within the next 5 years.

Figure 86 shows the net change in annual fossil fuel energy consumption for the beer processing sector relative to 2019 levels. The results show that by 2035, under the business as usual scenario, a modest reduction of 1.34 million AUD per year is expected. However, importantly, the modelling also shows that the trend in annual energy costs is expected to rise post 2035 under the BaU scenario. By contrast, under the accelerated scenario, by 2035 a net annual savings in energy costs of 8.2 million AUD is expected, with this cost expected to continue to reduce post 2035.

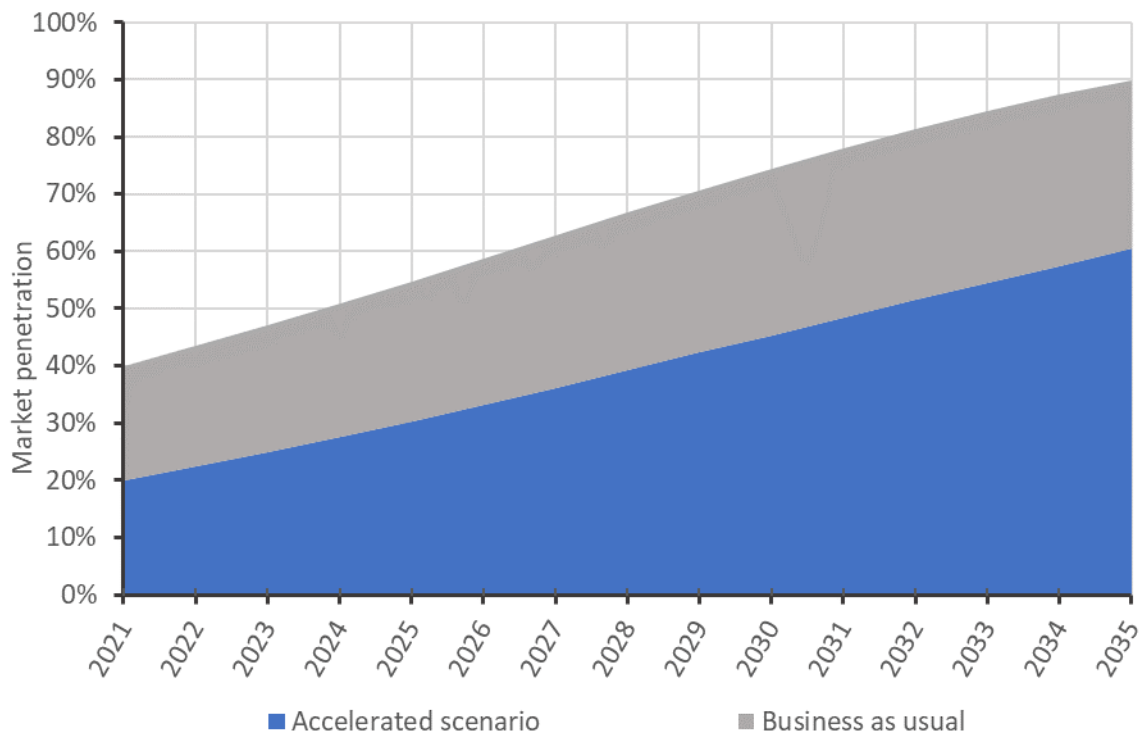

Figure 84: The overall new technology market penetration in beer production under BAU and ACL scenarios.

## Electrification & Renewables to Displace Fossil Fuel Process Heating

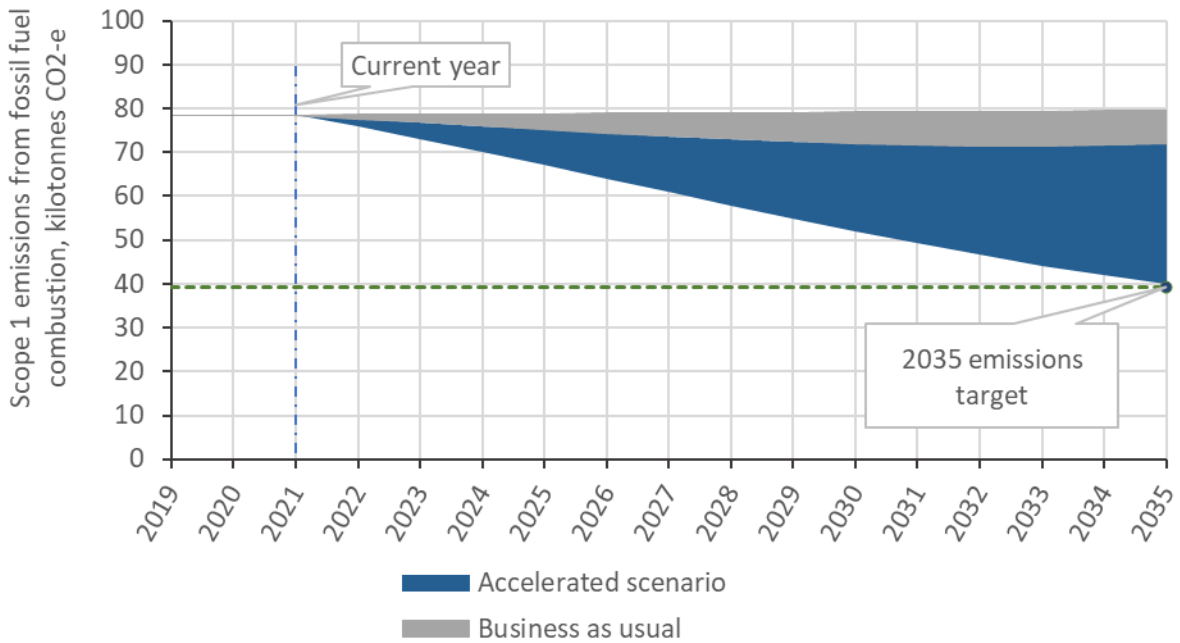

Figure 85: Projected scope 1 GHG emission reduction up to 2035 for beer production under BAU and ACL scenarios.

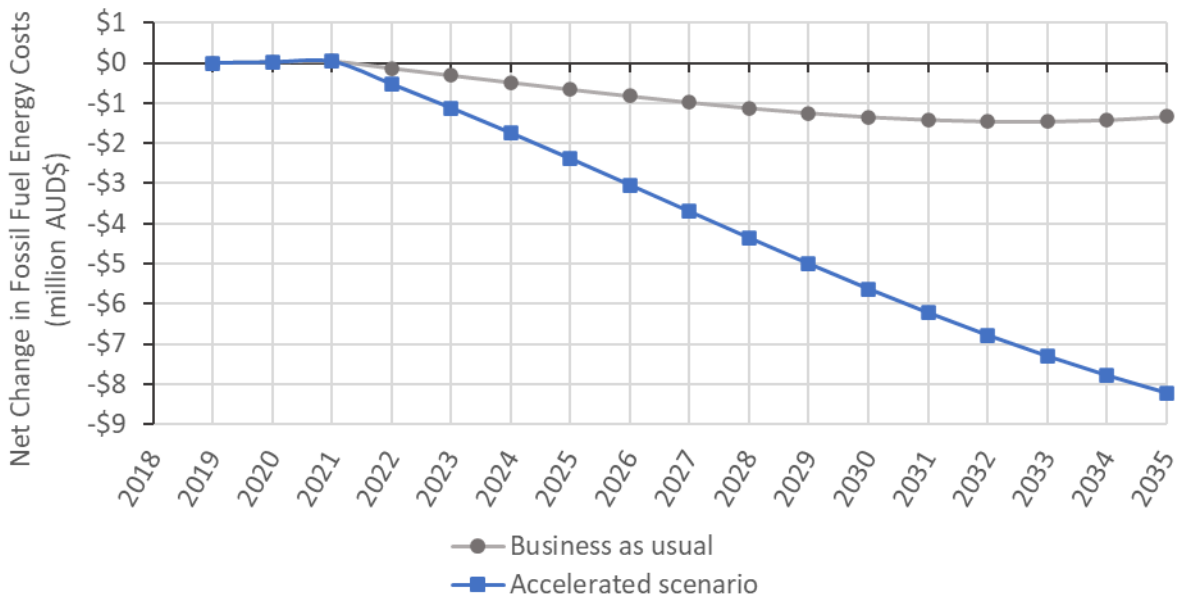

Figure 86: Net change in annual fossil fuel energy costs relative to 2019 levels.

### 4.4.4 Food & Agriculture: Discussion

The BAU case represents past trends of technology adoption and considers the value proposition of existing solutions. Effective decarbonisation can occur in a staged process for an end user, on the basis that an individual end user begins adopting solutions today. However, this adoption process cannot be applied across the entire sector. Therefore, under the BAU scenario, it is likely that some end users will achieve substantial decarbonization while most will not. The ACL scenario was developed on the basis that a dramatic increase in the value proposition could be developed or identified in the short term of the various technology options. The techno-economic analysis identified a number of

potential solutions which end users could adopt that could achieve this outcome. Therefore, the ACL scenario applies strong uptake rate reflecting this potential.

A major driver for the ACL scenario is the adoption of best practice energy efficiency as outlined in the Tech Review. Energy costs are generally less than 5% of the operating budget of many of the businesses involved. As a result, limited attention is placed on reducing this consumption in favour of more significant costs and production concerns. The application of best practice energy efficiency can be viewed as a confidence building measure for the business. Many Small/Medium Enterprises have substantial energy costs in absolute terms but require clear solutions with immediate and guaranteed benefits. Best practice efficiency measures could deliver that benefit, enabling interest, risk appetite and investment into technology options, which are inherently more complex.

The techno-economic analysis identified that to achieve a strong value proposition, substantial CAPEX reductions and high savings are needed. This can be achieved in the short term through detailed site-specific analysis. This is beyond the scope of this study and represents an immediate research need.

Initially it is clear that the opportunity for renewable energy solutions exist for LPG systems. This market has not only the potential to drive down costs for all technologies but also to reduce the risk and provide proof sites for the technology. As volumes increase, these CAPEX values will reduce. More importantly integration costs and balance of system costs will also reduce. This process inevitably produces a volume of renewable heat which can compete with natural gas. This has significant implications for biogas producers that use this biogas for heating, as there may be a value proposition for gas grid injection, while providing heating through other means. This injected gas can then be used for meeting residual annual heating needs, enabling 100% decarbonisation of heat. This value proposition becomes more relevant if natural gas prices rise over time.

Displacement of NG will likely occur in a staged manner where strong value propositions can be identified, offsetting technical, practical and market risks. For example, the use of HP/MVR and EB are ideal where on site 'free' solar PV is available. Thermal energy storage is ideal where solar thermal or HP/MVR have been established.

Finally, GHG emissions continue to decrease through the use of green fuels, principally, green methane/hydrogen, displacing the residual amount of heating. Furthermore, the option of direct electric heating will begin to be applied in later years as solutions are identified.



## 4.5 Commercial Buildings: Healthcare Facilities and Hotels

### Market potential at a glance

#### **For the healthcare sector:**

- As of 2020, Australian healthcare facilities currently consume 24.2 PJ of energy per year
  - Of this amount, 6.1 PJ/year is for thermal processes for <150 °C (which encompasses all thermal processes)
  - Process heat for <150 °C contributes 854 kilotonnes CO<sub>2,eq</sub> per annum
  - The energy costs associated with this process heat is estimated to be approximately \$130 million per annum
  - If no new renewable technologies are taken up, the energy demand for process heat is expected to increase by approximately 2.5% per annum
- Based on a logistic model, by 2035:
  - Under the BaU scenario, the emissions for process heat <150 °C would be 1040 kilotonnes CO<sub>2,eq</sub> per annum. This is an increase in emissions of 22% compared to 2019 levels;
  - Under the Accelerated Scenario, the emissions would be 427 kilotonnes CO<sub>2,eq</sub> per annum. This is a reduction in energy demand and emission by 59% compared to the BaU scenario;
  - Under the ACL scenario, energy costs are estimated to be reduced by \$35 million per year compared to BaU;
  - To achieve the 50% emissions target by 2035, the uptake rate of renewable technologies needs to be increased by a factor of 3.7 compared to BaU

#### **For the hotel sector:**

- As of 2020, Australian hotels consume 20.3 PJ/annum of energy
  - Of this amount, 7.3 PJ/annum is for thermal processes in the range <150 °C (which encompasses all thermal processes)
  - Process heat for <150 °C contributes 1,206 kilotonnes CO<sub>2,eq</sub> per annum
  - The energy costs associated with this process heat is estimated to be approximately \$164 million per annum
  - If no new renewable technologies are taken up, the energy demand for process heat is expected to increase by approximately 2.6% per annum
- Based on a logistic model, by 2035:
  - Under the BaU scenario, the emissions for process heat <150 °C would increase to 1,485 kilotonnes CO<sub>2,eq</sub> per annum. This is an increase in emissions by 23% relative to 2019 levels
  - Under the Accelerated Scenario, the emissions for process heat <150 °C would reduce to 603 kilotonnes CO<sub>2,eq</sub> per annum. This is a reduction in energy demand and emission by 59% compared to BaU
  - Under the ACL scenario, energy costs are estimated to be reduced by \$28 million per year compared to BaU;
  - To achieve the 50% emissions target by 2035, the uptake rate of renewable technologies needs to be increased by a factor of 3.6 compared to BaU

### 4.5.1 Introduction

#### 4.5.1.1 Heating in Healthcare: Hospitals and Aged Care Facilities

Hospitals and residential aged care (RAC) facilities represent the main commercial building types for healthcare services in Australia. Currently, there are more than 1300 hospitals and close to 2700 RAC facilities in Australia. As the gross floor areas of Australian healthcare buildings has been growing continuously over the past two decades from 12,045,360 m<sup>2</sup> in 1999 to 14,450,760 m<sup>2</sup> in 2020, the annual energy consumption and the associated GHG emissions have also seen steady increase, reaching 24.20 PJ and 3.9 Mt CO<sub>2,eq</sub> in 2020 (as shown in Figure 87).

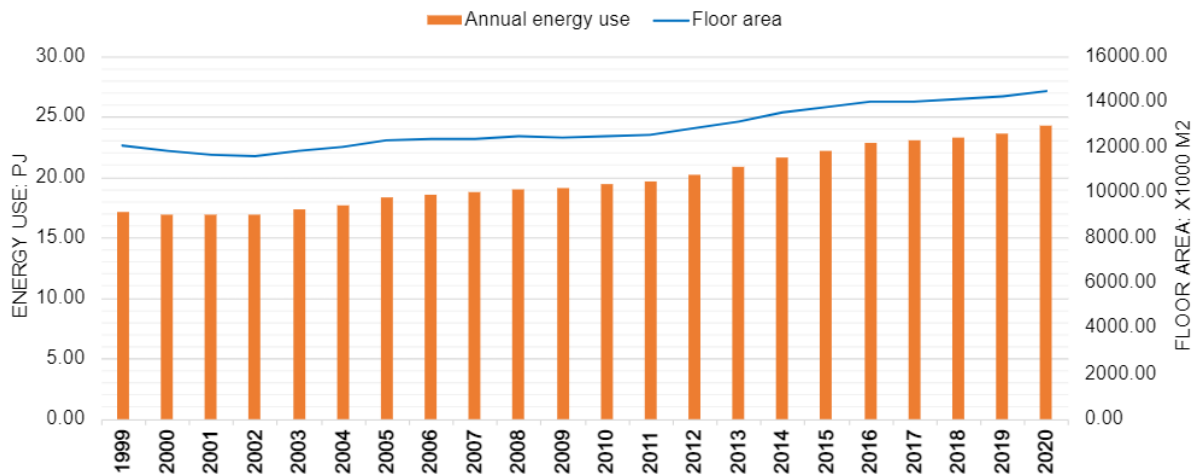

Figure 87: Annual energy consumption and floor area of healthcare buildings (1999-2020) [249].

The number of public hospitals is similar to the number of private hospitals. Whilst no statistics for fuel expenditure of public hospitals is available, it is found that private hospitals spent about 1% of their total expenditure, equivalent to 163 million AUD, on fuel and power. According to the Department of Climate Change and Energy Efficiency (2021), the annual electricity and gas consumptions by Australian hospitals in 2020 were 11.9 PJ and 11.5 PJ, representing 49% and 47% of the total energy consumption respectively [249]. Among typical fuel types used for hospital heating process, natural gas is a common energy source for water and gas heating in Australia [249]. The use of natural gas at hospitals are mostly for heating, hot water and sterilisation purposes, which account for 53% of total end use of gas, as shown in the Figure 88 [249].

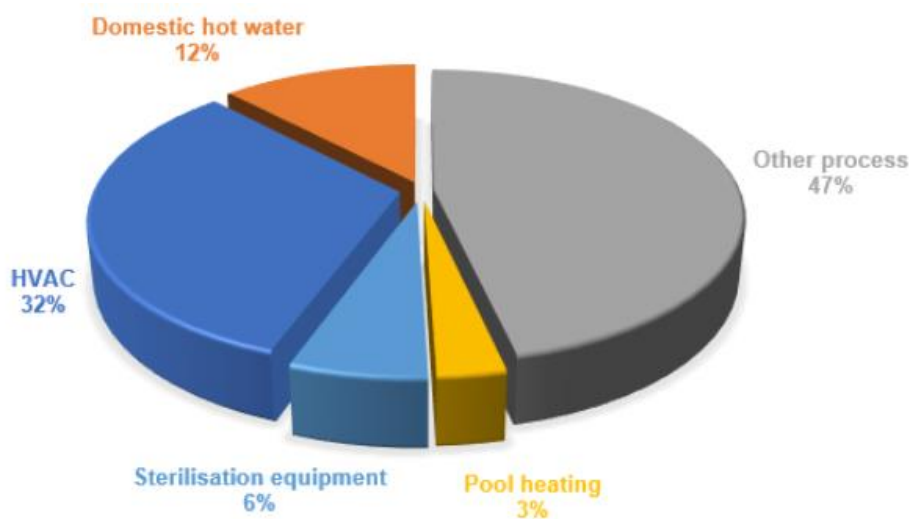

Figure 88: Natural gas for end use at Australian healthcare buildings (1999-2012) [249].

## Electrification & Renewables to Displace Fossil Fuel Process Heating

Figure 29 shows an example of a gas boiler-based heating system process flows for hospital operations, involving water heating and steam heating. The hot water is supplied at 75 °C to heat potable water and softened water, as well as for cleaning and washing. The steam heating system generates and supplies the steam at 180 °C for sterilisation and air conditioning humidifying purposes. These translate to approximately 213MJ per patient day for water heating and 137MJ per patient day for steam heating.

Like hospitals, RAC facilities also use natural gas for their water heating needs. However, the water heating process at RAC is more akin to mixed-use (residential and office) buildings. Figure 32 and Figure 33 present a typical water heating system for RAC and the estimated temperature and energy intensity ranges, respectively. Although hot water is normally supplied at a range of 45-50 °C for resident use and facility operations, it could be produced from water heaters or boilers at a temperature range of 50-80 °C for sanitary purposes. These translate approximately to the energy intensity of 5.3-7.5 MJ per resident per day.

### 4.5.1.2 Heating in Hotels

Meanwhile, hotels represent another main type of commercial building where natural gas is common energy source for heating. Excluding shared residential homes, Australia has more than 4400 hotels, motels and serviced apartments for accommodation and hospitality services. The sector has been growing continuously over the last twenty years in both floor areas and energy intensity, adding to increasing pressure to its carbon footprint, with 4.1 Mt CO<sub>2,eq</sub> as in 2020 (Figure 89).

In hotels, gas-based heating took up to 7.3 PJ per year as of 2020 or about 36% of the total energy consumption. 79% of gas use is to feed water heating systems to supply hot water for guest rooms, hotel services (including kitchen and laundry), space heating and swimming pools (Figure 90).

Figure 35 and Figure 36 illustrate a typical hotel hot water system and processes, from which hot water is often produced at 75-80 °C and utilised at 55-60 °C for rooms and hotel services, as well as 35 °C for swimming pools upon need.

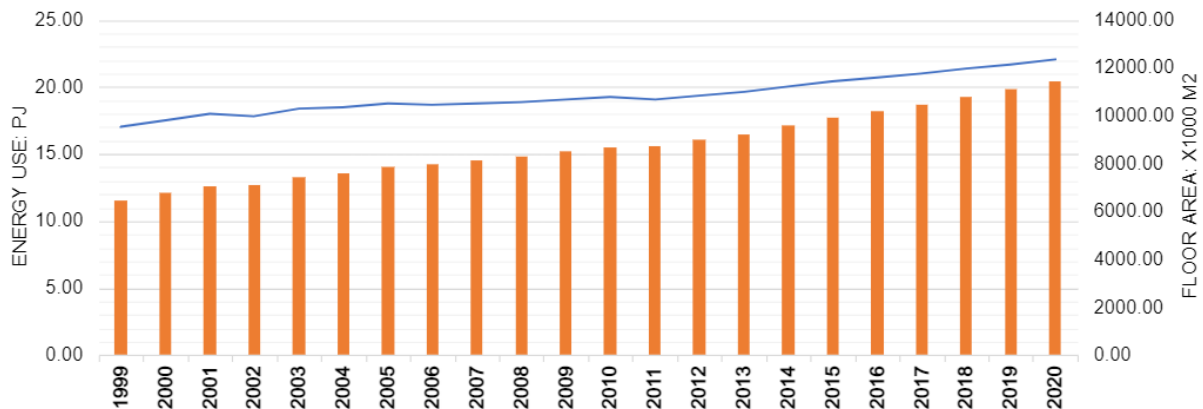

Figure 89: Annual energy consumption and floor area at Australian Hotels (1999-2020) [249].

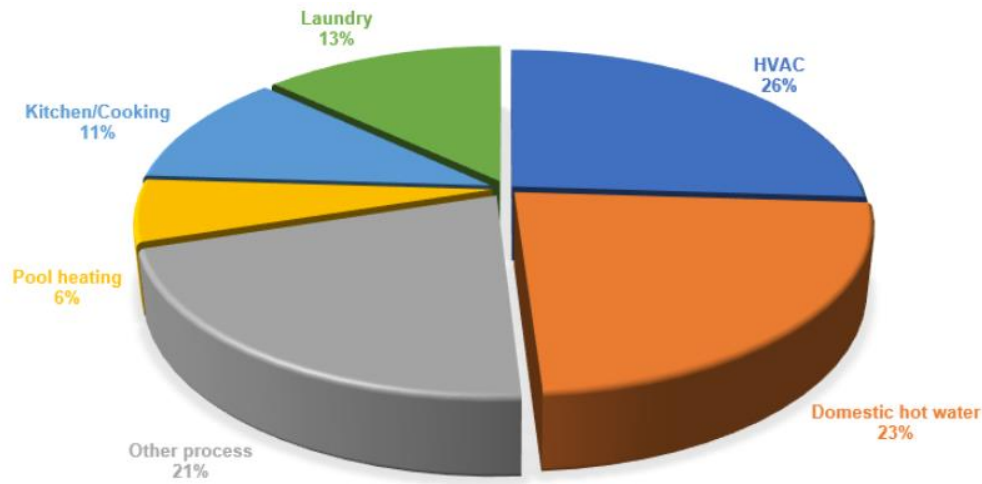

Figure 90: Natural gas for end use at Australian Hotels (1999-2012) [249].

#### 4.5.2 Renewable Energy Technologies for Heating Demand in Healthcare and Hotels

There are several alternative technology options for each process of gas-based heating for hot water and steam supply in healthcare buildings. The literature review indicated that electricity and gas account for 49% and 47% of the healthcare service-related energy consumption, respectively. Further breakdown shows that about 66% of electricity and nearly 100% of gas are used in process heating, including HVAC, domestic hot water, pool heating, sterilisation, and other processes. The configuration of healthcare process heating facilities is to have a centralised boiler which can produce temperatures up to 200 °C. Thus, it is convenient to deliver all heating needs in a downward cascading approach, returning the condensate at near ambient temperature. The central boilers with steam reticulation system could be replaced with point of end use alternatives, such as biogas/biomass/electric boilers or heat pumps. By doing so, energy saving could be achieved through reducing line losses (approximately 10-15% of total heat) from the supply end to the end-use facilities. Other benefits include improving system reliability and reducing maintenance cost and water consumption [3]. In addition, as around 50% of the energy use in healthcare buildings is from electricity, a cleaner grid with high penetration of solar PVs would reduce considerable carbon emissions without increasing investment on facilities upgrade/appliances. Thus, a desirable payback period can be achieved. The replacement of conventional gas heating systems with renewable energy-based heating facilities is of great importance in decarbonising healthcare buildings, due to the near net-zero carbon emission feature of renewable energy and carbon intensive nature of gas fuels. In the light of above, solar PVs with central boilers would be a desirable and economical solution to improve the energy efficiency and reduce the environmental impacts for healthcare buildings.

Regarding to the energy efficiency improvement for process heating facilities in healthcare buildings, the following technologies might be considered. Immediate efficiency gains can also be achieved by using mechanical vapour recompression (MVR) and thermal vapour recompression (TVR) in process heating with the overall COP as high as 30-50 [1]. Current heat pumps can supply steam or hot water up to 160 °C, or hot air up to 120 °C with a moderate COP of 2-5 (Technology Review Report). However, future technology could improve the performance and increase the supply temperature up to 200 °C [1], which in turn can fulfil the process heating demand in healthcare buildings. Heat pumps and MVR are limited to temperatures up to 180 °C and might not meet all the load, however, they are of the potential to fulfil all the load in the near future with the technical improvements. Therefore, optimal techno-economic solutions combining heat pumps and MVR is feasible considering the heating requirement of 180 °C for steam production. Moreover, an improvement to 200 °C can be expected to increase the system resilience in the near future. Besides, a unique characteristic of CO<sub>2</sub> heat pumps

is the ability to conduct both refrigeration and steam production in a single stage of compression, minimising CAPEX. Furthermore, the outlet temperature from the heating side has no impact on the COP, as with sub-critical heat pumps, but rather the COP is maximised with a lower inlet temperature. Consequently, it may be possible to deliver refrigeration and effectively 'free' steam, with the same CAPEX for this technology.

From the perspective of energy saving, solar thermal and energy recovery could be potential solutions. Solar thermal can deliver sufficient high temperature steam, and therefore could meet the higher temperature load for sterilisation and hospital AHU steam humidifiers. Lower temperature obtained by heat exchanging then can be used to heat up potable and softened water. The footprint would be similar to any on-site solar PV facility driving a HP/MVR configuration, however much smaller than a similar solar PV facility driving an electric boiler. An inherent disadvantage is the reliance on high solar irradiance to deliver high temperatures. On the other side, heat recovery from steam and hot water could be ideal as a "free resource" to heat up pools, as their required temperature is only 35 °C which is much lower than that of hot water and steam. Statistics indicated that pool heating currently takes 3% of gas consumption in healthcare buildings, which means around 58.5 kt CO<sub>2,eq</sub> can be reduced annually in healthcare buildings.

The application of energy storage is critical for meeting night-time heating demands. This inevitably requires increased on-site renewable energy capacity. As opposed to a single central thermal storage system, there is advantage in having multiple thermal energy storage systems operating at different temperatures. This provides for efficiency gains, particularly if this store is used as a heat source for HP/MVR systems. For electric based systems, where a high COP is achieved with HP/MVR systems a centralised battery is probably most cost effective. Since electricity is ubiquitous and so long as electrical infrastructure does not change, using a centralised battery to operate a HP/MVR probably is the most cost-effective approach.

Based on the discussion above, the technology options with the potential for reliable, affordable and clean energy supply at healthcare and hotel buildings can be summarised in Table 32.

## Electrification & Renewables to Displace Fossil Fuel Process Heating

Table 32: Technology options with the potential to electrify healthcare and hotel process heating.

Processes require heat	Hot water supply	Steam production	Pool heating
<b>Heat demand</b>	60-80°C	170-190°C	About 35°C
<b>(Hospitals)</b>	195-225MJ/patient day	130-140MJ/patient day	53-69MJ/patient day
<b>(Hotels)</b>	29.03-78.91MJ/guest day	3.85-10.46MJ/guest day	2.1-5.7MJ/guest day
<b>Option 1</b>	Reuse waste heat and reduce the heat loss from steam reticulation system		
<b>Option 2</b>	Biogas/biomass boiler		
<b>Option 3</b>	Solar PV + electric boiler (EB)		
<b>Option 4</b>	Solar PV + EB + storage (thermal or battery)		
<b>Option 5</b>	Solar thermal		
<b>Option 6</b>	Solar thermal + thermal energy storage		
<b>Option 7</b>	Solar PV + heat pump (HP)/MVR		
<b>Option 8</b>	Solar PV + HP/MVR + storage		
<b>Option 9</b>	-	-	Heat recovery from hot water and steam
<b>Example optimized option</b>	<b>PV + EB + storage</b>	<b>PV + HP + storage (decentralized system to minimize heat loss and optimize COP)</b>	<b>Heat recovery from hot water and steam</b>

### 4.5.3 Uptake Scenario: Healthcare and Hotels

The logistic growth function presented in Section 4.2 was adopted to simulate the market uptake rate of potential technology options to displace carbon emitting energy sources to produce process heat. Unlike other sectors considered in this report, a significant proportion (47% for healthcare buildings, and 61% for hotels) of the energy supplied for process heat comes from electricity. In the present analysis, we assume that the existing use of electricity is not carbon neutral, and that the uptake of renewable energy technologies includes the option to decarbonise this electricity consumption, either directly (i.e. installation of solar PV) or indirectly (via PPAs).

The uptake of renewable technology also includes provisions to displace direct fossil fuel use (e.g. from natural gas boilers). Each technology has its advantages and drawbacks and the decision on specific option selection is complex and needs to be analysed case by case. Theoretically, each new technology has its individual market adoption rate, however, determining these is beyond the scope of this study. To simplify, in this study, all the technology options are grouped as new technologies to decarbonise heating processes in both healthcare buildings and hotels. Hence, one uniform market update rate is used and it aims to achieve 100% potential market penetration (i.e. the parameter  $K$ ) ultimately. Some energy efficiency/saving technologies, such as electric boilers, heat pumps and solar PV, have been implemented and demonstrated in this industry. However, the market penetration for commercial buildings is still minimal and a 5% current adoption level ( $P_0$ ) is assumed. In ACL scenario, the growth factor ( $r$ ) is adjusted to 0.5 to ensure that the reduction of carbon emissions approaches 50% by 2035 compared to the level in 2020. The historical information on new technology adoption rate is not available. Therefore, the growth factor in BAU scenario is assumed to be 0.25, half of that in ACL scenario. This assumption is also established by taking into account a relatively low investment on reducing carbon intensity (approximately 3.7%) in comparison with growth of the sector reflected

## Electrification & Renewables to Displace Fossil Fuel Process Heating

by increased gas intensity with the total floor area (estimated at 15-17%), translating to a factor of 0.22-0.26. With this growth factor, it will take 52 years for 100% electrification for the healthcare buildings. The parameters to generate the logistic growth function for the two scenarios of BAU and ACL are listed in Table 33.

Table 33: Logistic function parameters for renewable energy uptake in healthcare and hotel buildings

Uptake scenario model parameter		Business-as-usual	Accelerated Scenario
<b>Potential market penetration of alternative technologies</b>	$K_0$	100%	100%
<b>Initial technology adoption level (as of 2021)</b>	$P_0$	5%	5%
<b>Growth/uptake factor</b>	$r$	0.12	0.24

For healthcare buildings, the overall new technology uptake trend, carbon reduction potential, and projected savings (in both energy offset and energy expenditure) under the two scenarios, i.e. BAU and ACL, are illustrated in Figure 91 (a-b). Scenario analysis indicates that under the accelerated scenario, the total market penetration of renewables would have to be approximately 73% by 2035. Under the accelerated scenario, carbon emissions would be reduced by 427 kilotonnes CO<sub>2,eq</sub> per annum by 2035, while under the business as usual scenario, in 2035 the annual emissions would actually increase to 1.04 million tonnes CO<sub>2,eq</sub> per annum. That is, in 2035, under the accelerated scenario a reduction of 613 kilotonnes CO<sub>2,eq</sub> per annum relative to the BaU scenario can be realised.

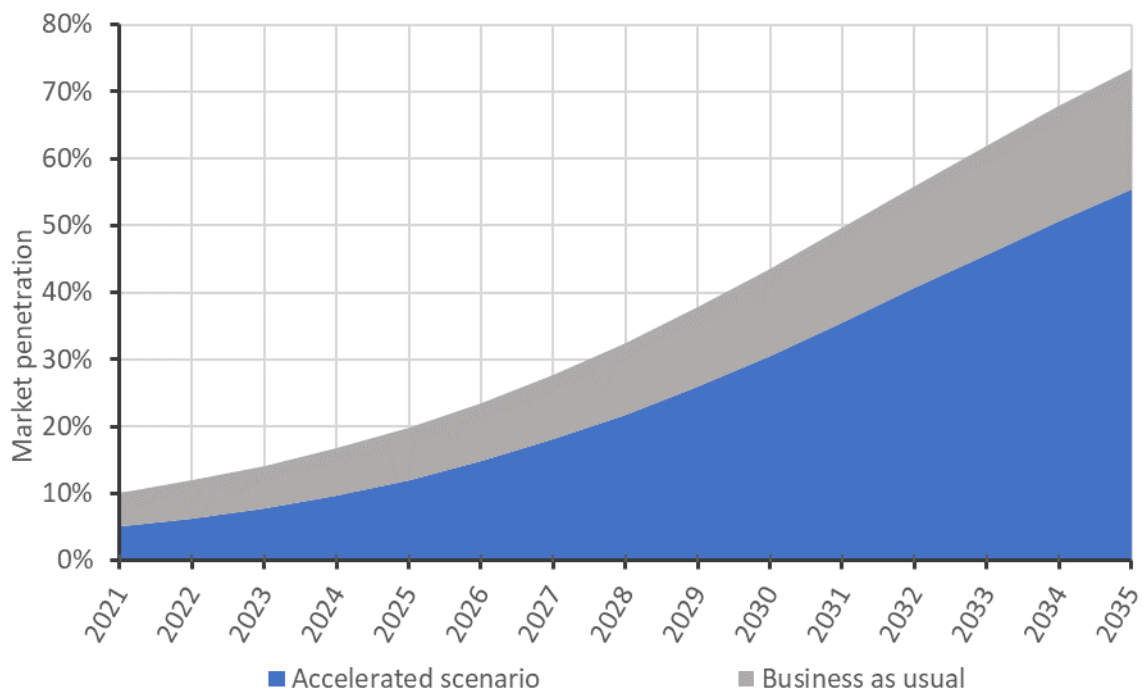

(a) Renewable energy market prediction (%)

## Electrification & Renewables to Displace Fossil Fuel Process Heating

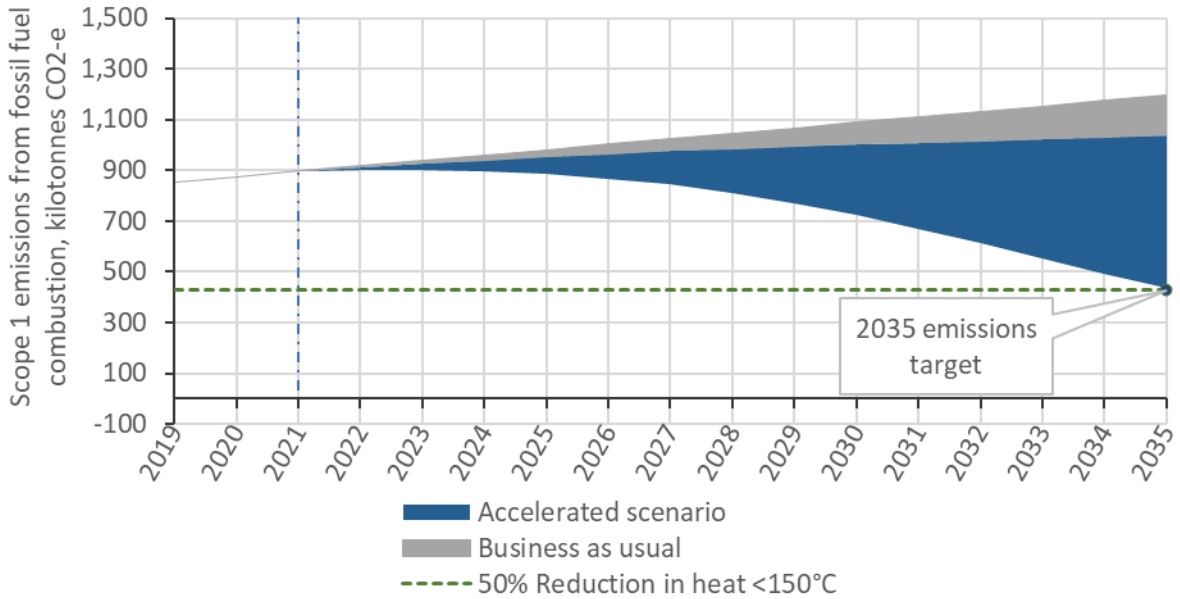

(b) Carbon reduction with the penetration of renewable energy and storage technologies (Mt CO2e/year)

Figure 91: Renewable technology uptake and impacts on carbon and energy savings for Australian healthcare buildings

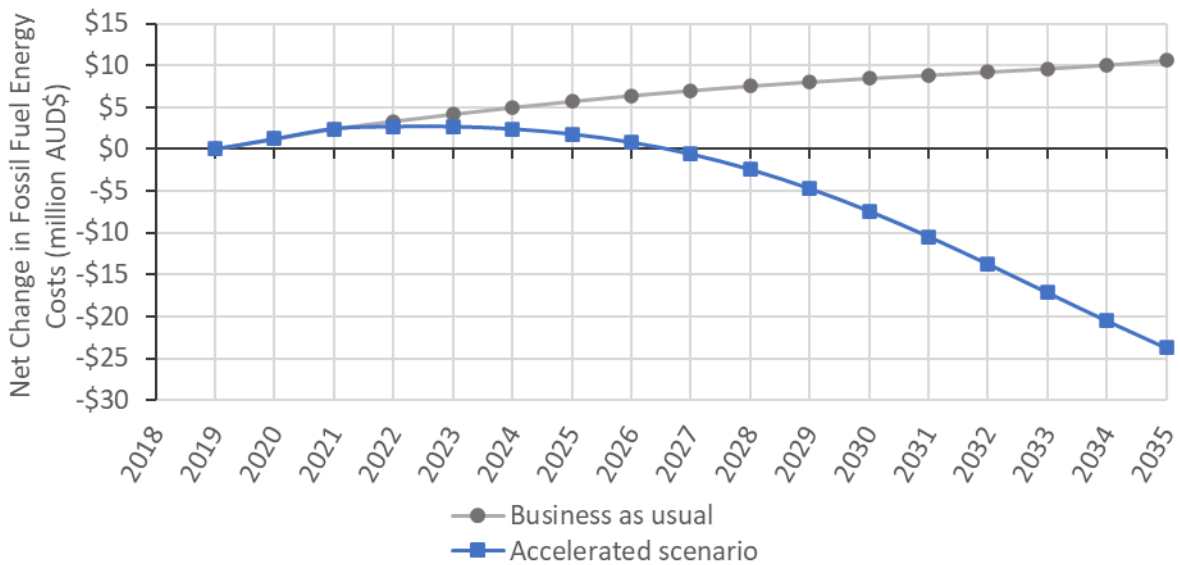

Figure 92: Net change in fossil fuel energy cost for Australian healthcare buildings relative to 2019 levels

Figure 92 shows the estimated net change in annual fossil fuel energy cost for Australian healthcare buildings. The results show that by 2035, a net saving of approximately 24.3 million AUD dollars per annum can be released under the accelerated scenario relative to 2019 levels. Importantly, under business as usual scenario, the annual fossil fuel energy cost will continue to increase beyond 2035, with an increase of 10.5 million AUD per annum expected by 2035. That is, the accelerated scenario will reduce fossil fuel energy consumption by approximately 35 million AUD relative to the BaU scenario.



For hotels, the overall new technology uptake trend, carbon reduction potential, and projected savings (in both energy offset and energy expenditure) under BAU and ACL scenarios are presented in Figure 93 (a-b). Scenario analysis indicated that with the growth of market uptake to 98.3% in 2035, an annual carbon reduction of 1.5 Mt CO<sub>2,eq</sub> can be achieved which is about 43% of the annual the carbon emissions associated with annual process heating at the hotel sector. As discussed in the previous section, about 35.78% of the total energy is from the carbon-intensive gas fuels, the proportion is even lower than the healthcare sector. Also, like the healthcare sector, the applications of process heating are in a very low temperature range of 35-60 °C. Such a combination of factors makes it more challenging for hotels to reach the 2035 carbon reduction target (given as 50%) when the energy grid is already very clean.

## Electrification & Renewables to Displace Fossil Fuel Process Heating

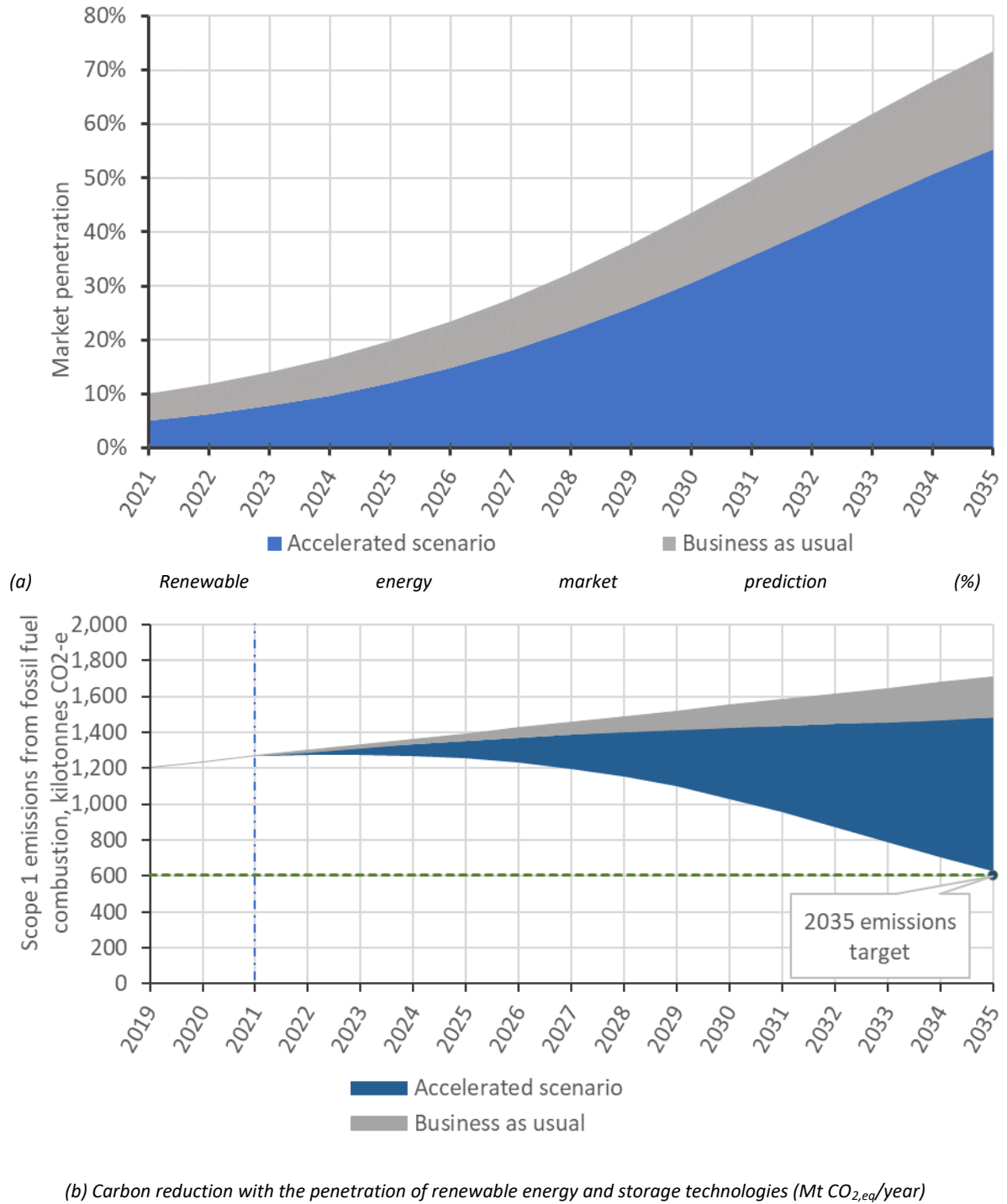

Figure 93: Renewable technology uptake and impacts on carbon and energy savings for Australian hotels

## Electrification & Renewables to Displace Fossil Fuel Process Heating

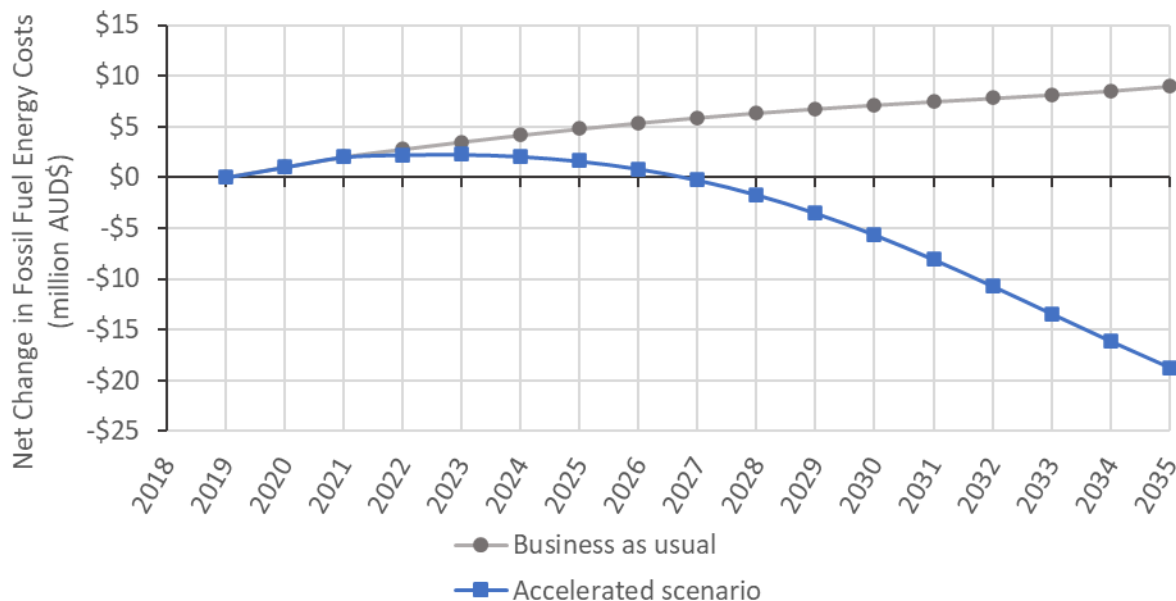

Figure 94: Net change in annual fossil fuel energy cost for the Australian hotel sector relative to 2019 levels

Figure 94 shows the net change in annual fossil fuel energy cost for the Australian hotel sector relative to 2019 levels for both the BaU and accelerated scenarios. Similar to the healthcare sector, the results show that the annual fossil fuel energy cost will continue to rise under the BaU scenario, with an increase of 9 million AUD per annum relative to 2019 levels by 2035. By contrast, under the accelerated scenario, the fossil fuel energy cost will reduce to below 2019 levels by 2027, and by 2035, the resultant reduction is approximately 18.7 million AUD per annum. That is, in 2035, the accelerated scenario will result in a reduction of fossil fuel energy use by 28 million AUD compared to BaU.

### 4.6 Market Potential Summary

An analysis of Australia's manufacturing, food & agriculture and commercial buildings sectors have indicated significant opportunity to reduce energy consumption and greenhouse gas emissions due to the consumption of fossil fuels for industrial process heat requirements in the temperature range <150 °C. Specifically, through the increased uptake of renewable energy technologies such as high temperature heat pumps, electric boilers, solar thermal systems, thermal energy storage systems, biofuels and solar PV, together with energy efficiency measures such as mechanical vapour recompression and heat recovery, significant reductions in ongoing fuel consumption costs and emissions can be realised.

A summary of the reductions in energy costs and emissions in 2035 relative to 2019 levels for the business-as-usual and accelerated scenarios are presented in Figure 95 and Figure 96, respectively. As can be seen, the largest opportunities to reduce emissions and energy costs is in the alumina refining sector. However, significant opportunities also lie in other sectors, in particular the buildings sector (i.e. hotels and healthcare), meat processing, dairy processing and pulp and paper production.

Results also indicate that for many sectors, the reduction in energy costs and emissions under the business as usual scenario is either very small or negative (that is, an increase). The latter is particularly evident for the healthcare and hotel sectors, where the growth in energy consumption is expected to exceed the uptake rate of renewable technologies.

## Electrification & Renewables to Displace Fossil Fuel Process Heating

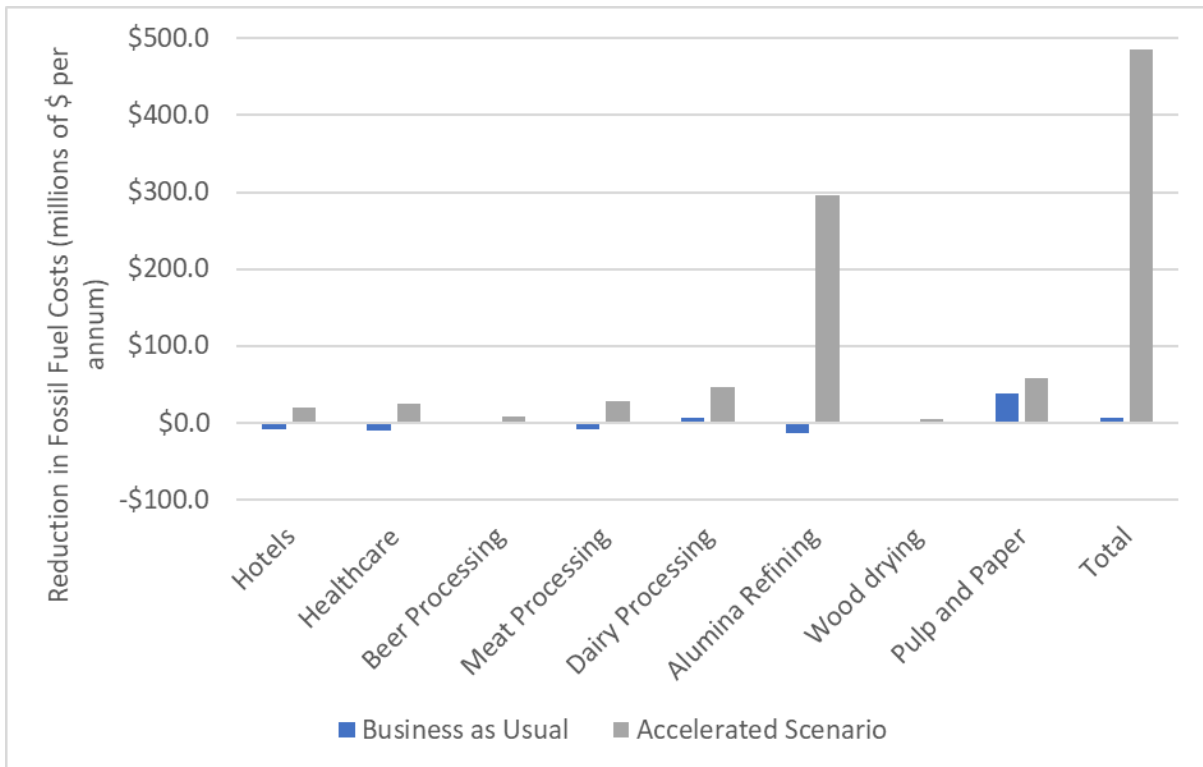

Figure 95: Summary of reduction in fossil fuel energy costs in 2035 relative to 2019 levels for the different sectors considered in the present analysis for both the business-as-usual and accelerated scenario. Note that a negative value shows an increase in cost.

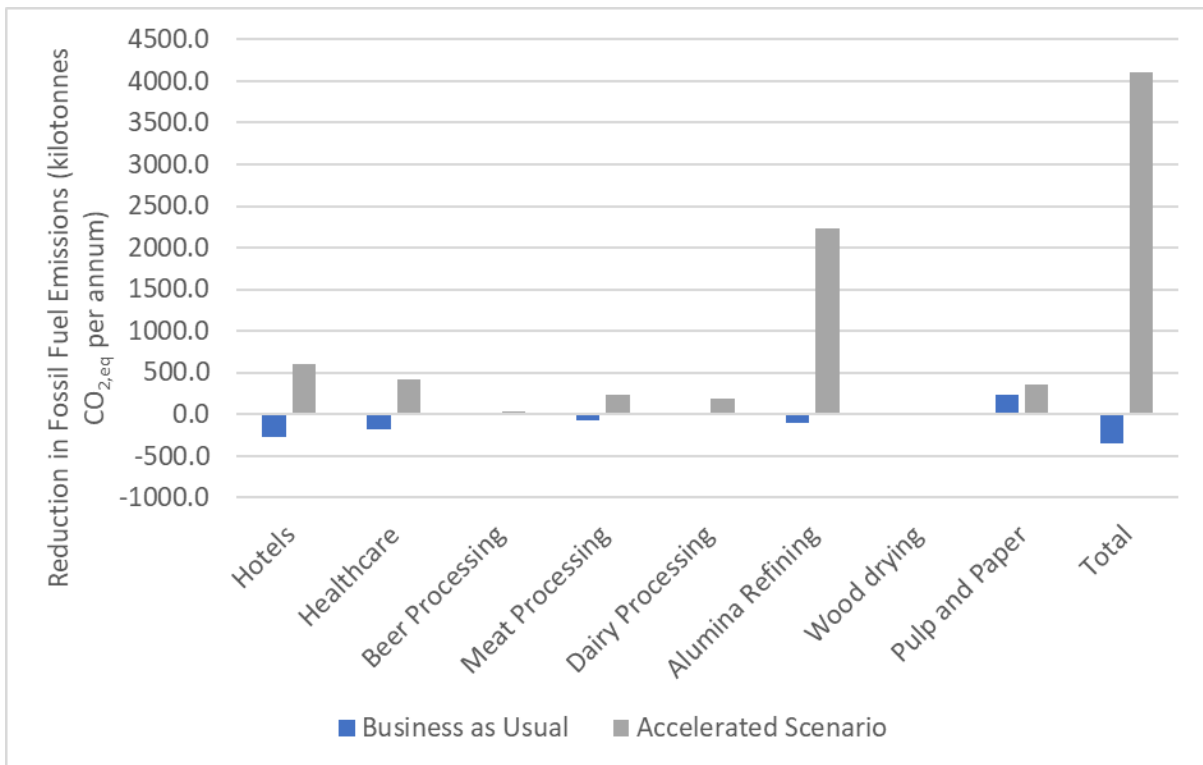

Figure 96: Summary of reduction in annual greenhouse gas emissions in 2035 relative to 2019 levels for the different sectors considered in the current analysis for both the business-as-usual and accelerated scenario. Note that negative values show an increase in emissions.

## Electrification & Renewables to Displace Fossil Fuel Process Heating

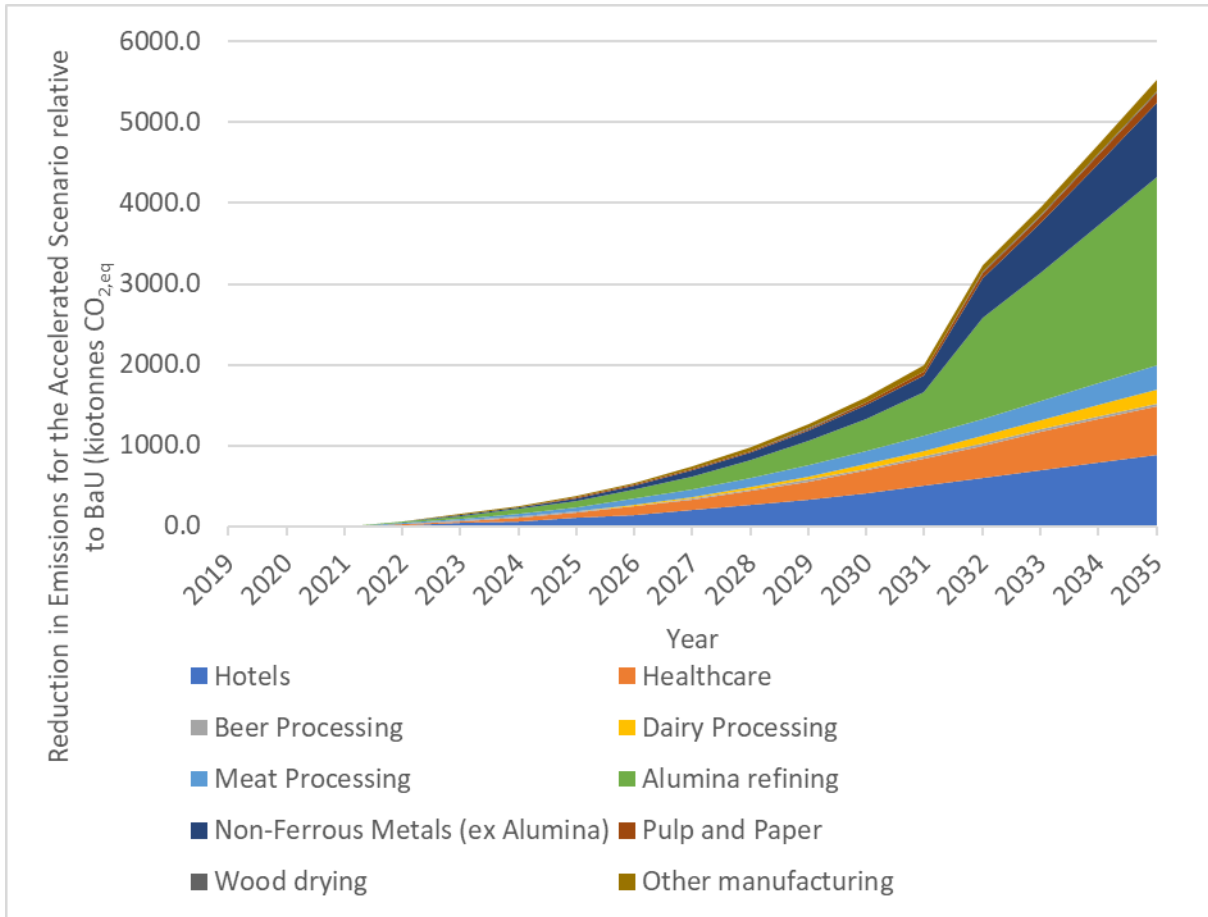

Figure 97: Reduction in CO<sub>2</sub> equivalent emissions from process heat for all the major sectors considered in this report under the accelerated scenario relative to business as usual.

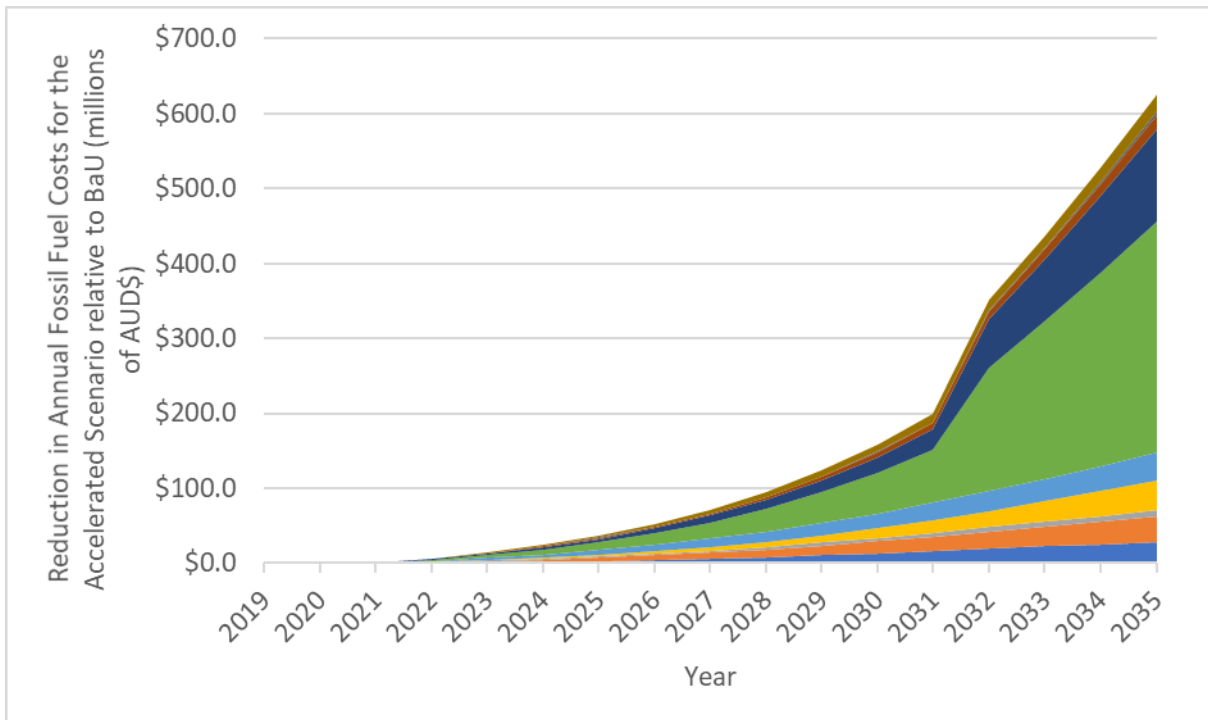

Figure 98: Reduction in annual fossil fuel cost from process heat for all the major sectors considered in this report under the accelerated scenario relative to business as usual.

Figure 97 and Figure 98 show the total reduction in emissions and fossil fuel energy costs for the sectors considered in the current analysis for the accelerated scenario, relative to business as usual. Unlike Figure 95 and Figure 96, here we have also included an estimate for the entire non-ferrous metal processing sector (excluding alumina), together with all other manufacturing. The estimations for the latter two are high-level approximations as described in Section 4.3.4.

As can be seen, under the accelerated scenario, total annual energy savings on the order of 600 million AUD per annum can be achieved relative to business as usual for all the individual sub-sectors considered in the current analysis. It is estimated that this will result in a reduction of more than 5 megatonnes CO<sub>2,eq</sub> per annum. It should also be noted that the current analysis encompasses only approximately 25% of all of Australia's industrial process heat requirements (with many other sectors and process temperature ranges falling outside the current scope). That is, if the uptake rates achieved under the current accelerated scenario is realised throughout all industries and temperature ranges, a four-fold increase in energy savings and emissions reductions can potentially be anticipated. However, the technology uptake rates under the current accelerated scenario are likely to be challenging to achieve, particularly for high temperature processes.

On average, across the sectors other than alumina refining, the uptake rate of renewable technologies and energy efficiencies measures needs to accelerate by at least a factor of four relative to current levels to achieve the savings under the accelerated scenario. There is no technological panacea here, but rather the different sectors and operators will need to consider all the options listed above (and in the Technology Review section) to select the ones most suitable for their specific conditions. The exception here is alumina refining, which "on paper" requires a 40-fold increase in renewable technology uptake to achieve the accelerated scenario. This is because the alumina refining process has traditionally been hard-to-abate, and hence the current rate of uptake is almost negligible. For sectors such as these, step-changes in technologies (such as mechanical vapour recompression) appropriate for these sectors will need to be realised. Therefore, an overarching research strategy which prioritises both incremental advances in a range of renewable options together with targeted investment to promote step-changes in key technologies is recommended.

The key research gaps identified in this market potential are summarised in the following page.

**Research Gap: System modelling tools**

- There is a lack of reliable modelling tools capable of modelling overall system/process performance, and/or modelling the impact of each technology
- In particular, more detailed modelling tools are required to assess the scale of improvement (in terms of cost reduction, emission reduction, and product quality improvement) that can be realized for each process and for different renewable technology options that are currently available
- Accurate component-wise modelling tools are also required to improve understanding of how each new renewable technology operates under different conditions and how these technologies can be effectively integrated into existing processes

**Research Gap: Lack of technology demonstration**

- While a wide array of renewable technology options exists in the market, there is a distinct lack of case studies or existing plants that utilise these technologies
- The poor current renewable technology uptake rate may be increased through the development of pilot projects and/or identification of case studies from around the world which successfully utilise renewable technologies to supply process heat under conditions relevant to industrial systems

**Research Gap: Waste heat and waste product opportunities**

- There are significant opportunities to decarbonise process heat through more effective use of either waste heat or waste products
- Almost all investigated processes produce waste heat that could potentially be used to improve efficiency. Examples of technologies that could potentially use waste heat beneficially include heat pumps and mechanical vapour recompression
- Waste products, such as bagasse and wastewater, can also potentially be used either directly as biofuels or indirectly to produce biogas (e.g. through anaerobic digestion)

**Research Gap: Retro-fit opportunities**

- There is a current lack of understanding on how renewable process heat technologies can be retro-fitted and integrated into existing processes
- In particular, there is lack of understanding on how much retro-fitting is required, and how much of the existing infrastructure can accommodate the renewable technologies

## 5 Barriers

### 5.1 Introduction

Alongside the significant decarbonisation opportunity presented by low temperature process heat, barriers associated with the process integration must be identified, and actions and proposals need to be made to achieve the net-zero carbon emission goal. The focus of this section is to identify key potential barriers that can prevent or impede the implementation of carbon-neutral emission of the process heat up to 150 °C.

The section provides an overview of the barriers related to the decarbonising process heat in industry and other important sectors, through electrification and renewables. Some of the barriers considered in this report might not be applicable for all the sectors assessed in this opportunity assessment study and newer barriers might emerge in future. Similarly, relevant barriers – and opportunities – to electrifying process heat via the grid may be further addressed in other RACE for 2030 CRC studies, albeit with different, broader foci (e.g. flexible demand). In this study, the cost per unit production is considered higher for electrical and renewables-based process than the conventional fossil fuel such as natural gas and coal-based processes. In future, the scenarios might change rapidly, and natural gas prices might be higher than the renewable source prices, or carbon levies may be introduced that might affect the outcome of this barrier analysis.

The methodology for the assessment of barriers in electrification and renewable integration to displace process heat is first described. Different barrier categories are then described in detail, and then actions and proposals to overcome those barriers are discussed in subsequent subsections. Barriers for heating electrification in the healthcare sector are then considered as a use case for barrier analysis. Alongside the barrier analysis, recommendations and a list of future research directions are provided at the end of the section.

### 5.2 Barrier Methodology

Potential barriers to implementing renewables and/or electrification-based process heat, and providing actions and proposals recommendation to overcome those barriers, were focussed on the sectors identified in Section 2.

#### 5.2.1 Barrier categorisation

Barriers for electrification and renewables to displace fossil fuel process heat may be categorised as technical, non-technical, regulatory, and economical barriers. Challenges pertaining to the electrification and/or integrating renewables technologies and impacts on power grid power fall into technical barriers. On the other hand, non-technical barriers cover the lack of knowledge, skills, and training required for readiness for electrification of heat process, simulation tools, cultural barriers, and lack of sufficient information or precedents. The challenges related to the risk, hidden cost, access to capital, relevant regulations, and policies to adopt new challenges are considered under regulatory and economic barriers [250, 251]. A simple overview of barrier classification is provided in Figure 99.



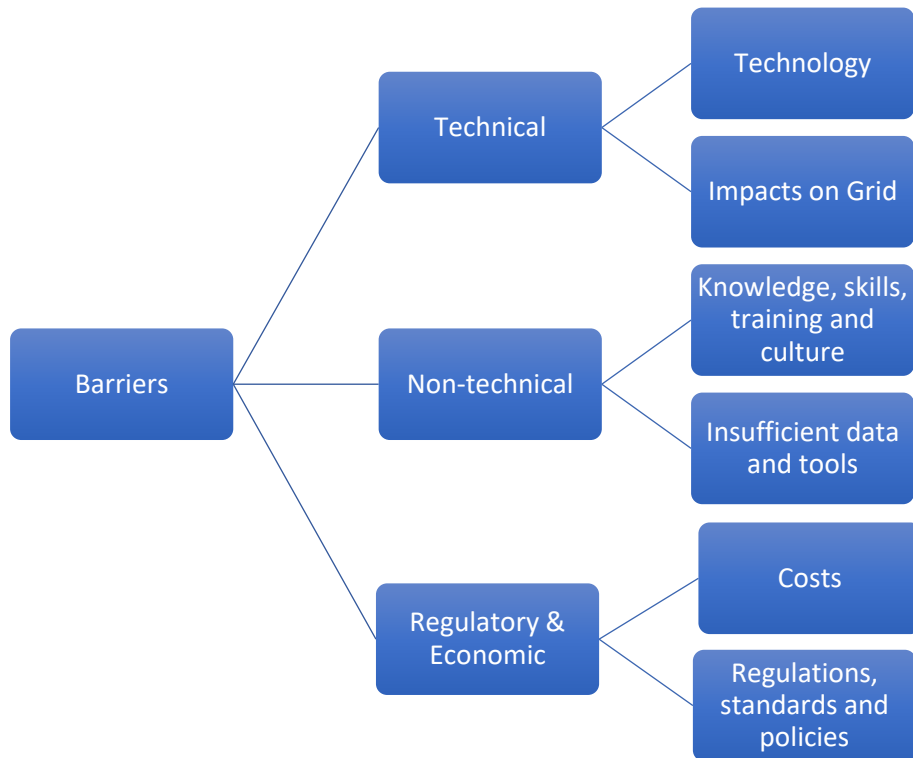

Figure 99. An overview of the classification of barriers to the electrification & renewables of process heat.

To investigate the impacts of the above-mentioned obstacles to implementing renewables and electrified process heat, all potential factors that can translate into each of these barriers should be identified and mapped in detail. Some of the valuable key barrier factors such as variable energy cost, uncertainty in policies, etc. were also suggested by members of a predominantly Australian industry reference group (IRG). All collected barriers under technical, non-technical, and regulatory and commercial categories are mapped in Figure 100, following a similar method of classification to [250, 251].

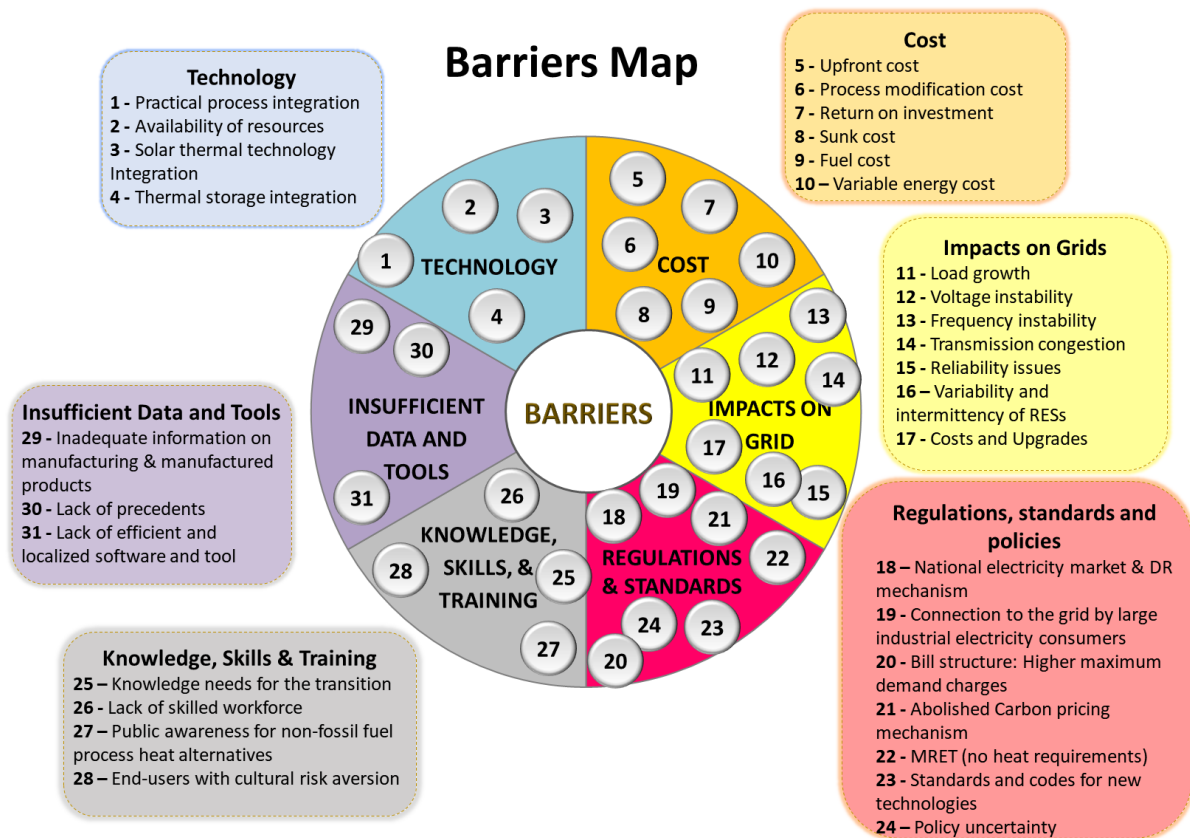

Figure 100. Barriers mapping for the process heat electrification & renewables integration.

### 5.2.2 Barriers’ review process

Once barriers have been identified and categorised, necessary proposals and actions are recommended to overcome those barriers.

- Foremost, barriers must pertain to the target sectors identified in Section 2, and the process heat temperatures of less than 150 °C.
- Mainly, barriers related to industrial process heat with temperature in scope are focused in this review. As numerous industries also use higher temperature process heat which needs medium- and long-term planning, other categories of barriers might emerge for this temperature level. However, most of the barriers reviewed in this report will be valid and could be useful for higher-temperature process heat as well.
- Several barriers are identified by reviewing academic and grey literature that have been distributed into few major categories as technology integration, costs, impacts on grids, regulations and standards, and knowledge, skills, training, and culture. Some key barriers such as variable renewable cost and policy uncertainty were also suggested by IRG members.
- Alongside barriers to process heat electrification and renewable integration, actions and proposals are recommended to overcome each of the barrier categories.
- Electrification of the health care sector is considered as a case study, and its barriers are discussed.

### 5.3 *Barriers to Electrification and Renewables in Industries*

#### 5.3.1 *Technology integration*

This section outlines the practical barriers associated with each technology. Technologies considered include high Technology Readiness Level (TRL) and commercially available technology as outlined in the Technology Review.

A common and significant practical challenge is the effective design of new technologies into plant configurations and control methodologies, considering appropriate local renewable resources. A substantial effort will be needed to integrate new technologies into the engineering and technical practices of plants operating below 150 °C.

##### 5.3.1.1 *Matching process integration issues to electrical technology*

Best practice energy efficiency includes those practices that are commonly used in the industry to manage energy usage for steam distribution systems. Therefore, these measures have essentially no practical barriers, and can readily be implemented.

Heat pump and mechanical vapour recompression (HP/MVR) technologies are restricted by maximum operating temperatures (of materials etc.). They also require an available (waste) heat source to achieve a sufficiently high Coefficient of Performance (COP) to be economically viable. Furthermore, where these technologies only partially achieve the heating needs, balancing the rest of the plant is a restriction. In addition, heat exchangers are required which can cost-effectively transfer the heat while not exceeding the pumping and temperature requirements of the plant. Space restrictions for sourcing of heat also needs consideration as it is likely to be within the plant area, and this is likely to be space constrained.

HP/MVR solutions inevitably require a (renewable) electricity source and associated electrical infrastructure to be part of a decarbonisation strategy. Although more significant for an electric boiler, which cannot produce COPs > 1, transformer capacity will limit the option for using electrified heat solutions. Transformer capacities are usually sized to site requirements, and therefore upgrades are likely. These upgrades could also be limited by upstream limits of network nodes. The network impact of electrifying these heat loads will be elaborated upon in Section 5.3.3.

Sufficient electrical network infrastructure is not necessarily readily available or currently used for many large industrial processes. Two examples of industries that co-generate process heat and electricity using fossil fuels are the alumina refining and pulp and paper making processes presented in the Market Status. In both cases, industries are located in relative proximity to both major electrical transmission lines and oil/gas pipelines (Figure 101), suggesting this is a financial decision as opposed to a barrier due to the availability of local electrical infrastructure. In these cases, the suitability of upgraded transformers and added network impacts may need to be weighed against local, renewable electricity generation. This, in turn, may face technology and regulation barriers as well as a lack of precedents in similar industries.

In contrast to large-scale manufacturing with electricity co-generation, several remote (12% of the total) and regional (41%) hospitals are situated away from both electrical and oil and gas network infrastructure. Many of these locations are in central Australia, with some exceptions in coastal north Western Australia and far north Queensland (see Section 2.3 for details on each sector). In these cases, displacing fossil fuels for process heat generation would be likely to require on-site electricity generation. This is not unique to the healthcare sector, with 1% of residential aged care being classified as remote.

## Electrification & Renewables to Displace Fossil Fuel Process Heating

Where heating is provided at sites which do not draw from the electrical network, it is possible that these upgrades can be avoided with sufficient on-site solar PV installation. Although practically restricted by space, sufficient on-site electricity generation could justify a HP/MVR or electric boiler solution.

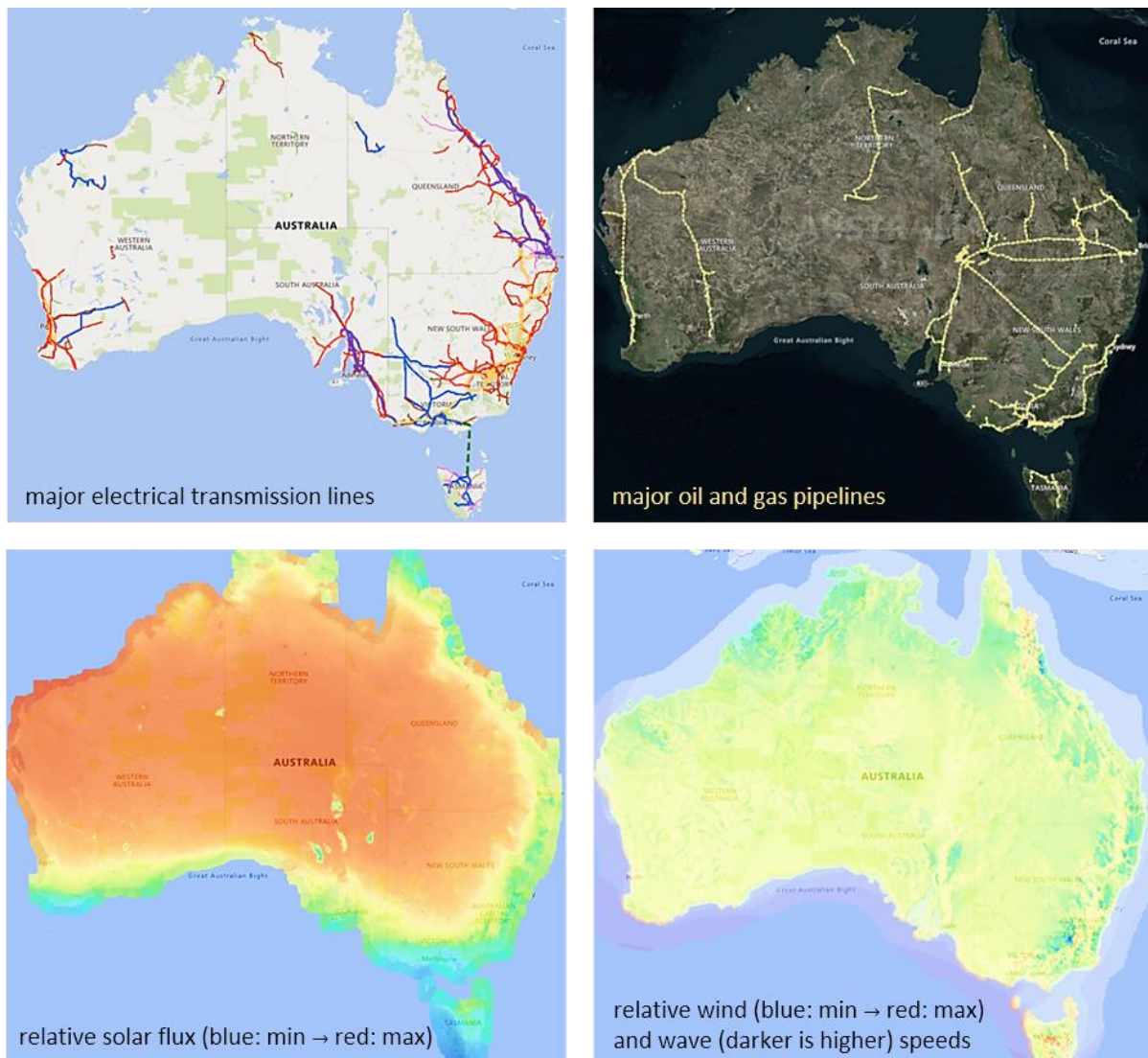

Figure 101. Maps showing (clockwise from top left): the distribution of electrical transmission lines; major oil and gas pipelines; relative annual mean wind- and wave-speeds; relative solar flux. Maps from [2].

Solar thermal heating is more space-efficient than solar PV [252], however when installed on the rooftop of a building weight restrictions apply that are unlikely an issue for solar PV. Solar thermal heating also needs to be located within a reasonable distance of the load to minimise parasitic heat losses. Solar thermal heating is furthermore restricted to areas with high irradiance levels during high demand. Concentrated solar is also dependant on the availability of direct radiation[252]. Finally, management of overheating and associated steam losses requires attention[252].

### 5.3.1.2 Thermal energy storage and biomass

The practical barriers associated with thermal energy storage (TES) are consistent with the requirements outlined earlier. Due to the relatively lower energy density of TES, space is an issue. Particularly given that the TES should be located within the plant confines, careful site identification is needed.

Although not inherently hazardous, TES does introduce atypical hazards which require managing. Being a stored source of energy, a TES, if it is damaged, releases that heat uncontrollably necessitating management according to a predefined response [253, 254]. Furthermore, for reasons of efficiency, some TES solutions use materials at high temperatures above those normally used in the industries which use low temperature heat [253, 254]. The use of a TES presents significant control and operational issues. Most plants operate statically while TES inherently means a dynamic operation. This dynamic operation changes the operation philosophy of the plant, which requires careful design and implementation.

Biomass options for delivering renewable heat include the production of biogas/biofuels and burning of biomass. The principal practical challenge will be sourcing sufficient feedstock at the required rate. Furthermore, managing the relevant pollution, wastewater and other environmental issues requires consideration. Finally, biomass is used as a feedstock for fertiliser in various forms in the agricultural sector. Therefore, balancing or co-producing this requirement needs to be considered [255-257].

### 5.3.1.3 *Thermal energy storage and flexible demand*

The practical barriers associated with thermal energy storage (TES) are consistent with the requirements outlined earlier. Due to the relatively lower energy density of TES, space is an issue. Particularly given that the TES should be located within the plant confines, careful site identification is needed [258].

#### Opportunities

TES can provide several advantages to an end-user, which needs to be fully explored, developed, and demonstrated. By sourcing lower-cost energy during charging, the TES upon discharging can deliver heating at lower energy costs. This lower-cost energy can come from a HP/MVR, a solar thermal system, or an electric boiler. Whilst not a specific barrier, the responsiveness of a TES system is limited by the thermal/thermomechanical system it is embedded in, including thermal properties of working fluids and physical inertia of any mechanical componentry (e.g. pumps, heat engines, turbines).

In being onsite, the TES can act as a technical hedge against high prices of electricity. TES enables the end-user to invest in a technical onsite solution which can be used to mitigate against high wholesale price events or high demand charge events. Where on-site solar PV provides an internalised fixed cost of heat to the end-user, TES is able to shift this internalised low price to those high-priced events. Overall, this enables TES to deliver certainty to electricity costs associated with the delivery of heat. In the case of gas prices, where volatility is low, TES can still be used as a price hedge against longer-term increases, particular with the fixed price of energy that on-site solar energy production delivers.

A TES can provide additional on-site heating capacity. Where additional heating is required from an existing heating plant and there is insufficient capacity, a TES can be used to absorb heat during times of low demand to meet this need. A TES can provide additional electrical capacity delaying transformer upgrades. For electrical-based solutions, where peak demand is approaching transformer limits, TES can load shift and delay upgrading of the transformer. There are, however, systems-level opportunities in optimising TES/battery storage systems for processes where electricity is generated on-site.

In the event of a power loss, a TES can provide a backup source of heat, avoiding production loss. As a result, for an electrically driven heating solution, it will be possible to maintain heating demand from a TES, providing sufficient time to actuate backup heat supplies. This can have a significant impact on aseptic production systems where any loss of power can result in the daily production being dumped as waste. However, this will require appropriate battery storage for meeting ancillary electrical loads.

The use of TES inevitably results in lower compressor run times in the case of an HP or MVR. This is a function of the compressors operating more often at full capacity, enabling charging. During discharging, compressors are off. In the medium term it may be possible to reduce maintenance costs as the time between scheduled maintenance increases. Furthermore, it will extend plant life, avoiding future capital expenditure (CAPEX) spend.

With export restrictions for commercial operators already in place in the Ergon and SAPN networks as an example (both static and dynamic), TES offers a clear opportunity for absorbing this lost solar PV electricity. Furthermore, with these restrictions likely to increase with time, this opportunity will increase. Although not as responsive as a battery (which may be capable of millisecond response times), TES can offer ancillary services to the market [259, 260]. Effectively a demand reduction measure operating in seconds, TES can provide support to the network. With the potential roll-out of the electrification of heat, this type of service should be integrated into this technology. Where TES is integrated with solar thermal to provide industrial heat, the issues to the network that an electrical solution involves are avoided.

### Requirements

TES can only be used where there is a difference in the load and the capacity for charging. In the case of an HP/MVR application, if the equipment is operating at rated capacity for 100% of the time, there is no opportunity for charging, and therefore no ability to have TES. Most plant configurations have additional capacity to allow for some redundancy and maintenance events, and therefore charging should be available in most cases.

In the case of an electric boiler, however less so for HP/MVR, sufficient electrical capacity is needed during charging times. The electrical capacity includes both local infrastructure (sub-boards) and mains infrastructure (site transformer). Upgrading this infrastructure is a significant cost.

The regulatory and standards that relate to TES are generally covered by existing processes. There are standards relating to molten salt tank storage for Concentrated Solar Power (CSP) applications, which could prove useful such as the American Society of Mechanical Engineers TES 1-2020. However, due to the variety of TES systems, probably of more value would be to have an industry guide to the use of TES highlighting relevant standards and codes.

TES systems are either characterised as direct, where the storage medium is the heat transfer fluid, or indirect, where the storage medium is separate from the HTF. For direct systems, most likely the TES is a steam accumulator an existing technology. However, for an indirect system, the storage medium will have associated hazards, WHS risks, and constraints which should be explored. Where relevant, TES should be included in an electric battery grid-related standard to support the network.

An often ignored but critical requirement is the use of effective control systems [261, 262]. The state of charge, control methodologies and parameters are well developed and integrated with batteries. For TES systems this may not be the case, despite the seamless integration with various on-site management systems being critical.

### 5.3.2 Costs

Both capital expenditures (CAPEX), and operating expenses (OPEX) influence the market penetration of the high-TRL technologies and the displacement of fossil fuel, as suggested in the Market Potential. In fact, gas boilers suffer relatively from high operation costs as a result of their efficiency ( $\approx 60\% - 80\%$ ), gas operating costs, considerable maintenance costs, and high energy losses in the overall system (e.g. heat loss in distribution, leaks, and condensate) [263]. On the other hand, many

of the suggested high-TRL technologies exhibits higher CAPEX, thus requiring major investments that may not fall within the investment plans of an industrial company and work as a barrier towards their implementation. Specifically, for:

### High-temperature industrial heat pumps

Current heat pumps can deliver temperatures of up to around 160 °C, with systems capable of a delivery temperature of 200 °C expected by 2030 [264]. As an example of capital costs, as reported [263], a 630 kW two-stage ammonia heat pump, that has been installed onto an existing refrigeration plant, in Lobethal Abattoir in South Australia in 2012, with a COP between 4.8 and 6.5, and heating daily 250,000L of water from 11°C to 75°C, cost 900,000 AUD (supply and install including high R&D as it was new in kind in Australia + GST). Other cost examples of industrial heat pumps for projects or case studies in Australia can be found in [263].

In fact, the cost of a heat pump depends on many factors such as its size and COP, according to the application. Generally, as a guide, the heat pump system's purchase price is around \$500 - \$2000 per kW (heating capacity) for capacities less than 500 kW, and around \$300-\$500 per kilowatt for systems of 1 MW and above [264]. The installation costs can be between 1 and 2 times the heat pump's price [264]. For comparison, the upfront costs related to equivalent gas-fired boilers could be the half [265, 266].

In relation to the energy efficiency and OPEX, the high temperature heat pump is advantageous with its COP characteristics. A COP of 3 for example, is equivalent to 300% efficiency as electrical-to-thermal. The COP increases with a smaller temperature lift, which defined as is the temperature difference between the output temperature of process fluid minus the input temperature at the "cold" source side. For instance, multi-cascaded heat pumps and MVRs with lower temperature lifts achieve higher COPs. Therefore, such COP is well increased when the heat pump captures waste heat (i.e. sensible and latent) –at the heat source- from exhaust streams, air, or waste water, as in MVRs, or when the heat pump can be used simultaneously for heating and cooling purposes (i.e. if the cold side at the evaporator is also utilised). This advantage leads to higher energy efficiency and savings, and therefore to lower OPEX realised with an economic benefit, compared to gas boilers of relatively low energy efficiency, e.g. 60% or 70%. This benefit is accentuated when accompanied with raising gas prices and falling electricity prices from renewables (e.g. solar). Additionally, hidden costs attributed to heat losses (e.g. in the distribution) that are incurred with a centralised boiler, can be saved with distributed heat pumps installed at the location of the applications. Such heat pump distributed system also increases reliability as compared to a centralised boiler, and avoids any cost related to it, as the shutdown of one heat pump does not affect the operation of others [263].

As a result of all of these factors, attractive overall economic results can be achieved as shown in Figure 102 that gives a general indication of the cost of delivered heat for each temperature lift of the heat pump, and considers different total costs for the power in AUD [236, 267]. For a temperature lift of 50 °C for example, and a delivered power cost of 15c/kWh, the cost of delivered heat from an industrial heat pump is around (or even less than) 9 \$/GJ (Figure 102). If a gas boiler with 70% efficiency is used with cost of gas equal to 8 \$/GJ, the cost of delivered heat from the gas boiler would be 11.4 \$/GJ. The general economic viability of a heat pump is present as in this example, with more attractiveness when the gas price is higher, even with higher temperature lifts or higher power costs. It is worth to note that future costs of industrial heat pumps (expectedly decreasing) would also suggest better economics.

## Electrification & Renewables to Displace Fossil Fuel Process Heating

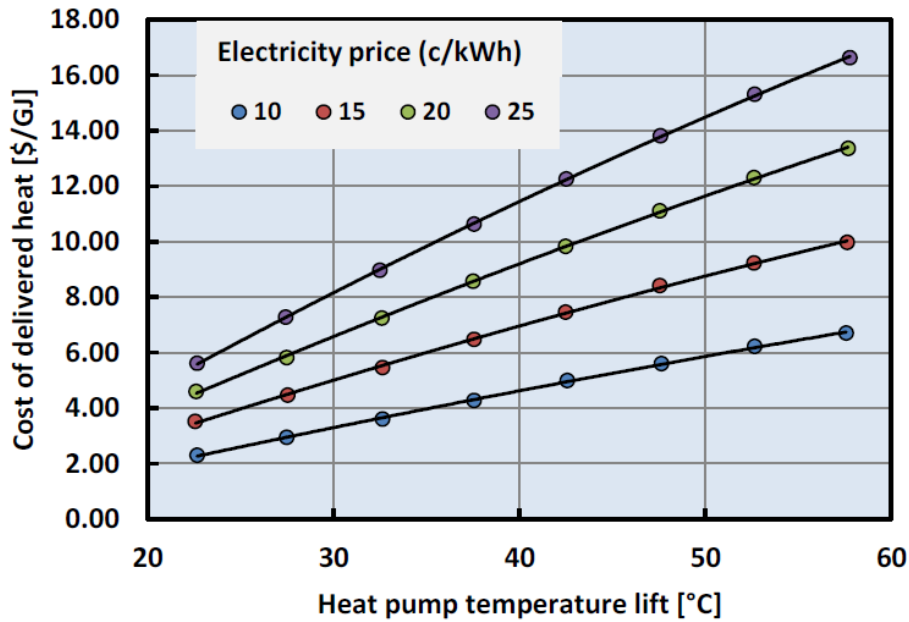
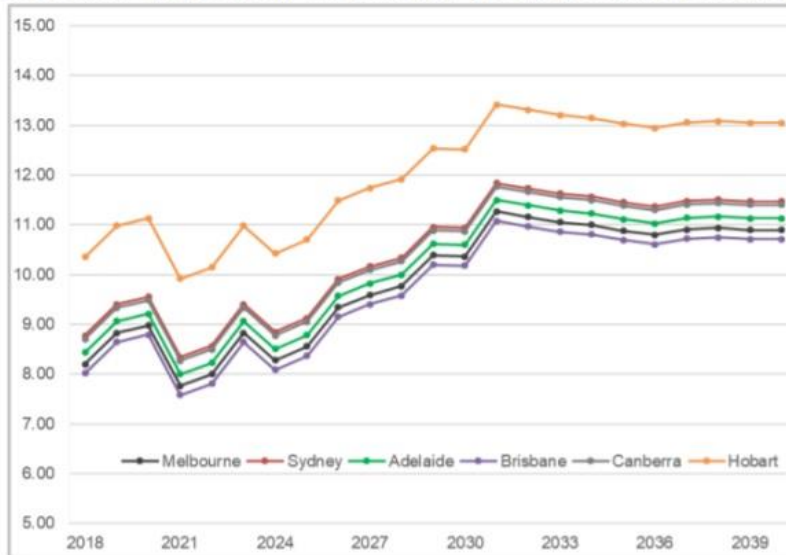

Figure 102. Cost of delivered heat in AUD with respect to temperature lift of industrial heat pumps as presented and as stated in [236, 267]: At pump evaporator temperature = 55°C Efficiency of heat pump cycle is 65% of thermodynamic maximum Information intends to present trends and does not apply to all cases

Additionally, projected increasing gas prices (Figure 103) [268], decreasing levelised cost of electricity (LCOE) from renewable energy [269] (Figure 104), and the projection of the extended LCOE including supporting technologies (e.g. batteries) (Figure 106), particularly with high share of renewables, would also suggest a lower levelised cost of heat for heat pumps, along with a higher delivery cost of heat for gas boilers in the future years.

R&C Delivered Price Retail Gas Price (EA) | Neutral Scenario | AUD/GJ real 1.2018



Source: Core Energy & Resources

Figure 103. Residential and commercial (R&C) gas price projections [268] for Eastern Australia in AUD/GJ based on AEMO neutral scenario, that is under mid-point projections of economic growth resulting to an estimation of energy consumption



## Electrification & Renewables to Displace Fossil Fuel Process Heating

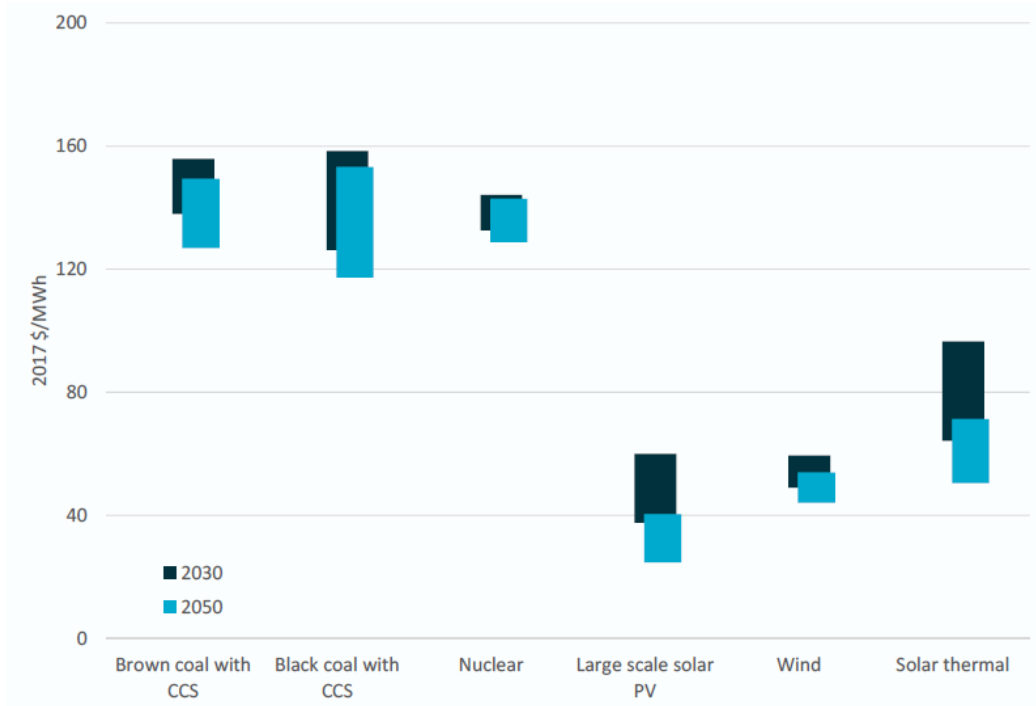

Figure 104. Estimation of projected levelised cost of electricity (LCOE) for different technologies with ranges between 2- and 4-degrees climate ambition scenarios, 7% weighted average real cost of capital, and ranges of assumptions presented in the table of Figure 105 [269]

	Capacity factor (%)		O&M 2050 (\$/MWh)		Fuel 2050 (\$/MWh)	
	Low	High	Low	High	Low	High
<b>Brown coal with CCS</b>	85	85	17	21	15	25
<b>Black coal with CCS</b>	85	85	14	17	25	49
<b>Nuclear</b>	85	85	12	15	11	22
<b>Large scale solar PV</b>	19	32	5	6	0	0
<b>Wind</b>	35	42	6	7	0	0
<b>Solar thermal</b>	40	55	12	17	0	0

Figure 105. Ranges for assumptions used to calculate the levelised cost of electricity for the above technologies [269]

## Electrification & Renewables to Displace Fossil Fuel Process Heating

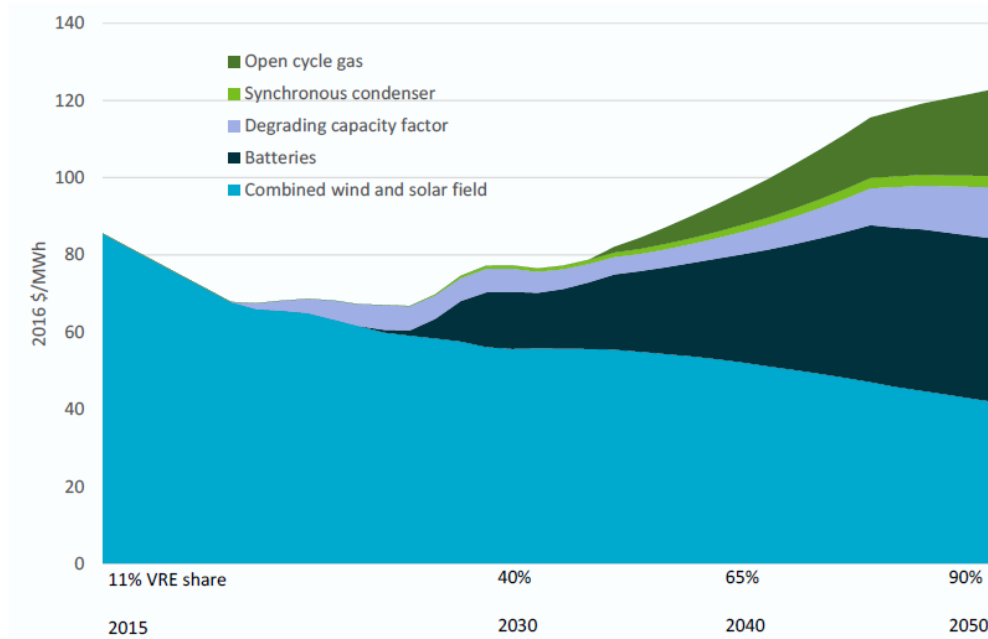

Figure 106. Projection of extended levelised cost of electricity with increasing share of variable renewable energy and supporting technologies such as storage [269]

Examples of case studies for process heat in the food industry using heat pumps delivering output fluids at temperatures between 66 °C and 150 °C were presented in an Australian study performed by A2EP in 2017 [263]. The examples show that over 15% internal rate of return could be achieved in various applications, realised based on only direct benefits of energy savings, with a payback period in many of them of 6 years [263]. However, a payback period of less than three years could be achieved with retired gas boilers, or when the heat pump is used for both heating and cooling at the same time [263]. This commercial viability has also been demonstrated in more detailed feasibility studies carried recently (in year 2020) by A2EP [270]. These studies considered industrial heat pumps powered renewably (i.e. by onsite PV) to replace existing conventional systems (i.e. gas boilers) in food processing, wine production, and brewing industries, in Australia, focusing on process heat temperatures of up to 95 °C. The resulting simple payback periods were in the range of 4+ years [270]. Similar case studies and examples were also examined internationally in IEA [271].

Despite the relatively economic attractiveness of the high temperature heat pump technology, access to finance or funds is seen as a barrier as per the survey' responses, considering its relatively higher CAPEX compared to gas boilers. Limited incentives till date were given in Australia, compared to more provided support (i.e. financial, promotional) seen in Japan and South Korea, and which has led to the rapid deployment of industrial heat pumps in both countries' industries [263].

### Solar-thermal systems

Figure 107 gives an indication of the specific costs versus temperature of solar-thermal collectors [264] (cost per square metre, divided by efficiency), as their performance (efficiency) depend highly on operating temperature. Costs of collector can be around 45% of total investment. Storage cost depends on the size and can be about 20% of the CAPEX; while the rest of the total cost goes for other system's components and installation [272].

## Electrification & Renewables to Displace Fossil Fuel Process Heating

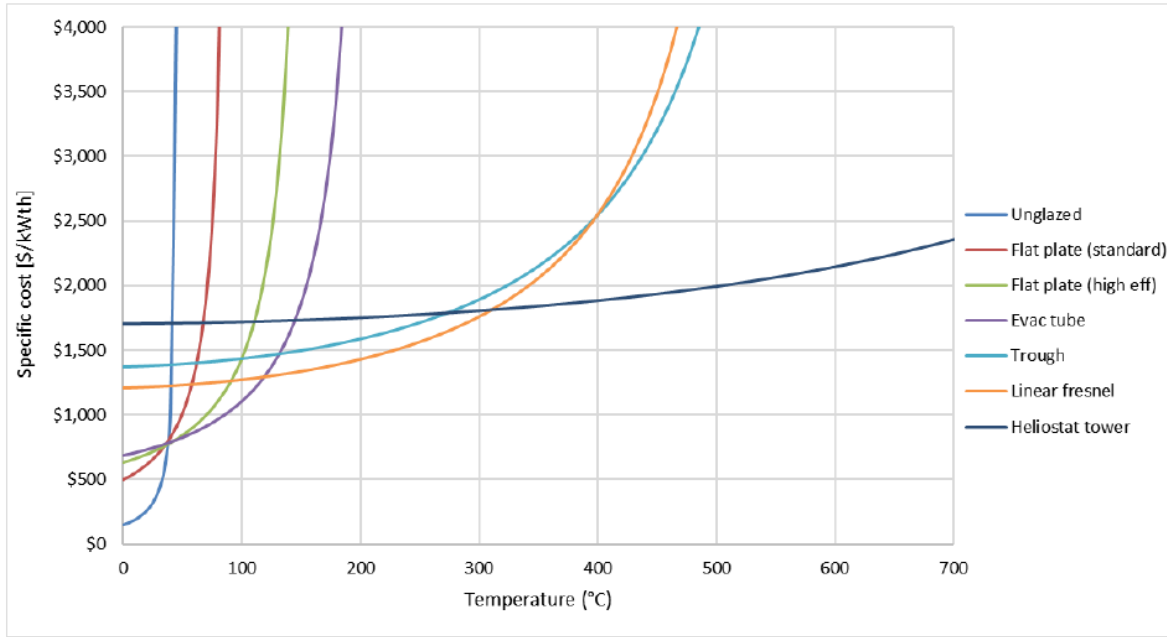

Figure 107. Indicative capital costs: installed cost per unit capacity of solar-thermal technologies versus temperature [264]

The OPEX cost for solar thermal systems is limited to some maintenance costs (i.e. 2% of CAPEX annually [264]) in addition to operation costs related to the electricity use by auxiliary equipment (i.e. depending on electricity price; annually around 1% to 1.8% of CAPEX) [272].

The levelised cost of heat (LCOH) of solar thermal systems vary with the solar resource available at the site. Particularly in Brisbane, the LCOH was found in [264] to be competitive for systems with temperatures below approximately 150 °C considering many ranges of gas prices. For solar-thermal systems with delivery temperature at around 200 °C (Fresnel concentrators or small trough), the LCOH was found competitive with gas prices around \$12/GJ, in the same location. With higher delivery temperatures, the LCOH became no more competitive compared with conventional fossil fuel based systems [264]. Despite that, still the CAPEX of solar-thermal systems and storages is a major barrier, and limited incentives are given.

### Biogas/Biomass boilers

When the feedstock to biogas/biomass boilers is taken from available waste streams in industries as suggested in the Market Potential, and is hence at a low or zero cost, this option remains competitive [264].

### Electric boilers

Electric boilers can benefit from renewable PV energy. However, they do not have the efficiency (COP) advantage of a heat pump, and they have their efficiency at around 100% (electric-to-thermal). The energy price sourcing per kWh for electricity is higher than that for gas, and hence, the electric boiler is generally more expensive to run compared to a gas-fired boiler, though the former has a comparable or lower CAPEX, is easy to install, and its efficiency is better [225].

The above measures for high-TRL technologies can give an indication of where these technologies sit economically with respect to the conventional gas boilers. However, such measures do not take into consideration detailed or hidden additional costs, particularly where spotted as major and required in the Market Potential, such as detailed costs of re-design and plant modification, mainly with retrofits.

Moreover, non-EPC (EPC: Engineering, procurement, and construction) costs like down time, training of personnel, business transformation would also add.

Even if a general economic viability is expected as indicated above, for each project targeting to use de-carbonisation technologies, a separate and complete feasibility study needs to be carried. Replacing a conventional equipment that has reached its end of life would surely make the project financially more attractive [263].

### ❖ *How to overcome the CAPEX barrier: Governmental incentives, grants, and rebates*

Incentives, grants, and rebates, particularly from government, as well as designed low-interest loans or funds for this transformation, can help overcome this up-front cost barrier and drive towards de-carbonisation. Funding for detailed feasibility studies needs to be provided [263]. Further suggestions will be given along Section 5.3.4 for certain policies that may incentivise the transition process towards de-carbonisation in industries, particularly when attractive rate of returns can be achieved. Financing mechanisms that help to overcome relatively high CAPEX are needed. Specific programs by some state governments have been put, though there is no incentive to switch from gas to electricity [263].

With more economies of scale reached for such high-TRL technologies along with more uptakes and more knowledge with standardisation applied, the capital cost of such technologies should decline. Additionally, with more deployment of renewable electricity generation, the cost of electricity as well as the electricity/gas price ratio is expected to go lower as suggested in Figure 103 and Figure 104, thus supporting the financial benefits towards electrification and decarbonisation of process heat. It is also important to be aware and consider the replacement options with these economical technologies, when the existing equipment is retired, so that the best financial benefits are obtained.

### *5.3.3 Impacts on the grid*

The electrification potential of industrial load (i.e., heat process) will mainly depend on the grid. In fact, the national electricity system in Australia is going through a transition from a dominated system of fossil fuel-based generation to a diverse portfolio of grid-scale variable renewable energy (VRE) and distributed energy resources (DERs) (i.e., behind the meter, microgrids, and virtual power plants). Actually, the 2020 Integrated System Plan (ISP) developed by the Australian Market Operator (AEMO) details a roadmap for the development of the national electricity system in the next two decades based on extensive stakeholder consultation and various scenarios for renewable energy integration and energy demand development [273]. For instance, while fossil fuel generators were still producing 77 per cent of electricity in the National Electricity Market (NEM) in 2019 [274], 63% of this generation resources are likely to age and exit over the next two decades. This is expected to be replaced by 2040, across all scenarios with 26 GW of Variable Renewable Energy (VRE), a back-up of 6-9 GW of dispatchable resources (e.g., storages, demand response), in addition to a doubling or tripling of DERs. In short, based on the ISP, renewable electricity generation in Australia is anticipated to be between 79% and 90% of total electricity generation by 2040 across all scenarios [275]. As parallel to this change, renewable power purchase agreements (PPA) have been rolled out, particularly for large electricity users, where the latter agrees through a retailer to purchase a specified percentage of a large renewable generation (in real time; e.g. from a solar farm) under a fixed unit price of electricity over a relatively long term [276].

## Electrification & Renewables to Displace Fossil Fuel Process Heating

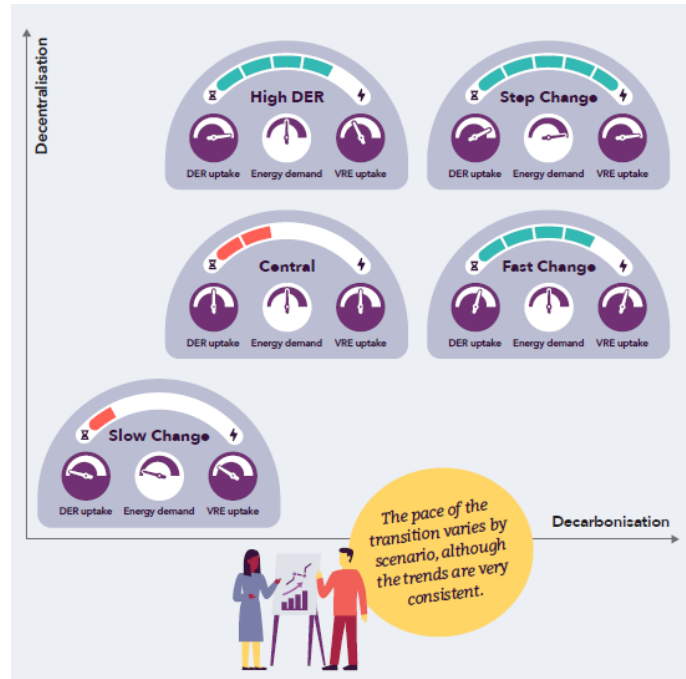

Figure 108. Illustration of various scenarios explored in AEMO 2020 ISP [273].

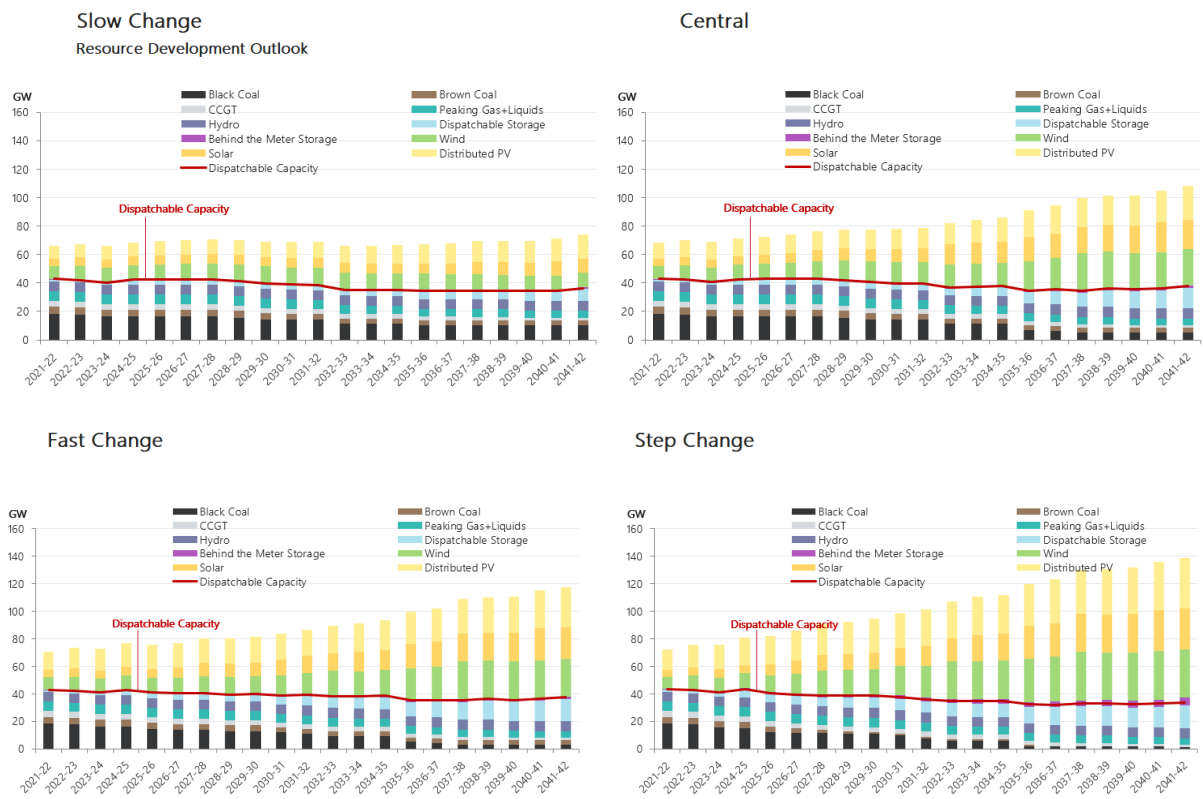

Figure 109. Power system development in the NEM across different scenarios – Source: [273].

On the other hand, Figure 110 shows the electrical demand forecasted by AEMO over the next two decades [277]. Electric vehicles are expected to increase the demand, while the forecast of rooftop PV and energy efficiency improvements will offset the global demand. It is worth noting that electrification potential for process heat has not been included in this energy demand forecast that

## Electrification & Renewables to Displace Fossil Fuel Process Heating

has been based on the ISP. However, it is necessary to be considered since heat electrification can lead to serious challenges regarding electrical utility connections and reliability as well as costs and upgrades in the power grid.

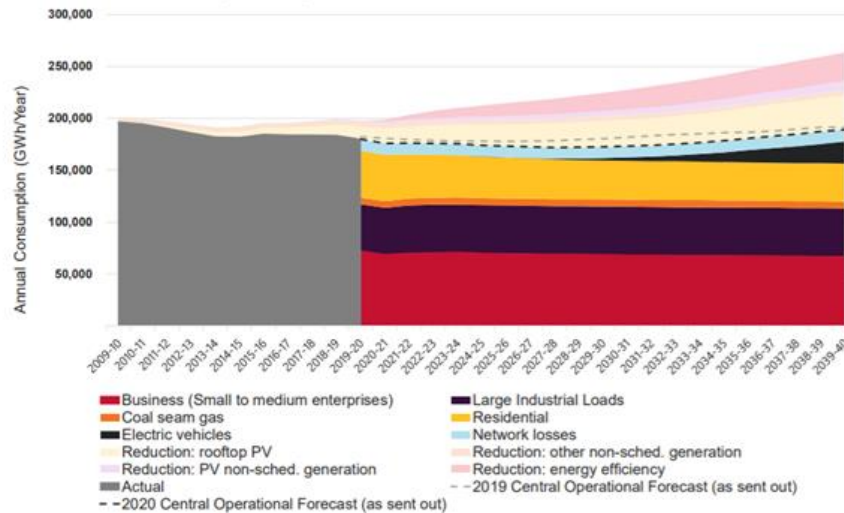

Figure 110. Electricity consumption in the National Electricity Market (NEM) in Australia as actual and forecasted [277].

### 5.3.3.1 Characteristics of the potentially electrified 'process heat' load Methodology

This subsection aims to evaluate how the electrification of process heat in the potential sectors with the temperature in scope could change the current Australian power grid's load profile. Figure 111 illustrates the overview of the analysis of characteristics of the potentially electrified 'process heat' loads. The analysis methodology can be highlighted in the following steps:

- Identifying high potential industrial and non-industrial sectors with the best opportunities for electrification of process heat. To do so, seven high-potential sectors identified by the "Market Status" report are selected for investigation.
- Identifying the process heat <150 °C and estimating the annual thermal energy (PJ/year) required for the process heating needs in the selected high-potential sectors.
- Considering the scenario of maximum electrification of the process heat. It is assumed that all processes in the range less than 150 °C have the capability to be fully electrified.
- Estimating the annual amount of electrical energy (MWh/year) needed to address the targeted heating needs in the selected sectors.
- Calculating the estimated 24-hour load profile of sectors resulting from the electrification of their process. Since insufficient information on the load profile of the sectors is available, the load demand of these sectors is calculated using the most relevant typical load pattern for each sector regarding their operating hours and time of use of heat.
- Evaluating the aggregated load demand resulting from the electrification of process heat in all targeted sectors.
- Extracting the current Australian 24-hour load profile data of the power grid from NEM. A busy working day in summer is considered for demand response and economic analysis.
- Calculating the whole load profile of the power grid after the electrification of process heat by combining the current network's load demand and the additional demand resulting from electrification.

## Electrification & Renewables to Displace Fossil Fuel Process Heating

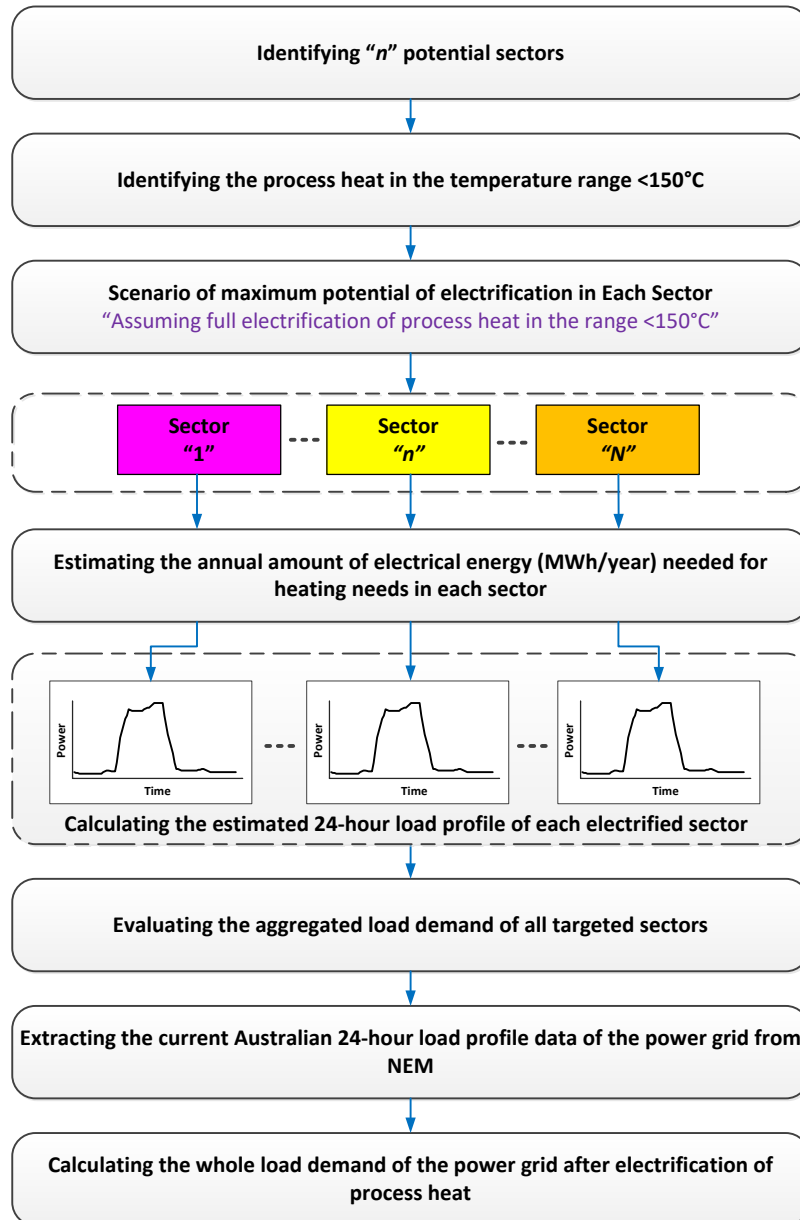

Figure 111. Overview of the analysis of characteristics of the potentially electrified 'process heat' loads.

### Current Australian power grid's load vs potential electrification of low temperature process heat

This section of the report targets the impacts of heat electrification of several high-potential sectors, including alumina and non-ferrous metals, pulp and paper, food, and beverage, while non-industrial sectors are hospitals, aged care facilities, and hotels.

The level of opportunity by targeted sectors is estimated by following the Market Status Section of this report and ARENA reports [1] and summarised in Table 34. All sectors have potential to use heat pump as a key renewable technology for decarbonising the process heat. However, 50% of the pulp & paper industry process heat needs can be supplied by using available bioenergy. In addition, heat pumps offer a high coefficient of performance (COP), i.e., 3 or more and substantially higher where leveraging waste heat. Whereas, conventional electrification by using boilers offers a relatively low COP, which is limited to 1.

## Electrification & Renewables to Displace Fossil Fuel Process Heating

*Table 34. Estimated renewables and electrification opportunities by sectors*

Sector	Total fossil fuel heat (<150 °C) use in PJ/year	Opportunity potential ST – 0 to 5 years MT – 0 to 10 years	Key renewable technologies					Comments
			Bioenergy	Geothermal	Heat Pump	Other electric	Solar thermal	
Alumina and non-ferrous metals	88	ST			✓		✓	Low temperature potential portion is accessible in medium term if barriers overcome.
		MT			✓		✓	
Wood and wood processing	3.4	ST	✓	✓	✓	✓	✓	Low temperatures first, all RE technologies have a role.
		MT	✓	✓	✓	✓	✓	
Pulp and paper industry	2.5	ST	✓					Strong use of bioenergy already. Progress may be limited by bioenergy supply, leverage other RE technologies for lower temperature processes.
		MT		✓	✓	✓	✓	
Food product processing and beverage sector	46.4	ST	✓	✓	✓	✓	✓	Low temperatures first, all RE technologies have a role.
		MT	✓	✓	✓	✓	✓	
Heating in Hospitals	6.5	ST	✓	✓	✓	✓	✓	Low temperatures first, all RE technologies have a role.
		MT	✓	✓	✓	✓	✓	
Heating in residential aged care facilities	0.51	ST	✓	✓	✓	✓	✓	Low temperatures first, all RE technologies have a role.
		MT	✓	✓	✓	✓	✓	
Heating in Hotels	1.1	ST	✓	✓	✓	✓	✓	Low temperatures first, all RE technologies have a role.
		MT	✓	✓	✓	✓	✓	

In order to evaluate the impacts of the additional load resulting from the electrification of heat on the power grid in the worst case, it is assumed that all thermal energy required for process heating can be electrified. Data on the current electricity load demand of a normal busy working day in different states in Australia is extracted from NEM [278] and the 24-hour load profile are shown in Figure 112.



## Electrification & Renewables to Displace Fossil Fuel Process Heating

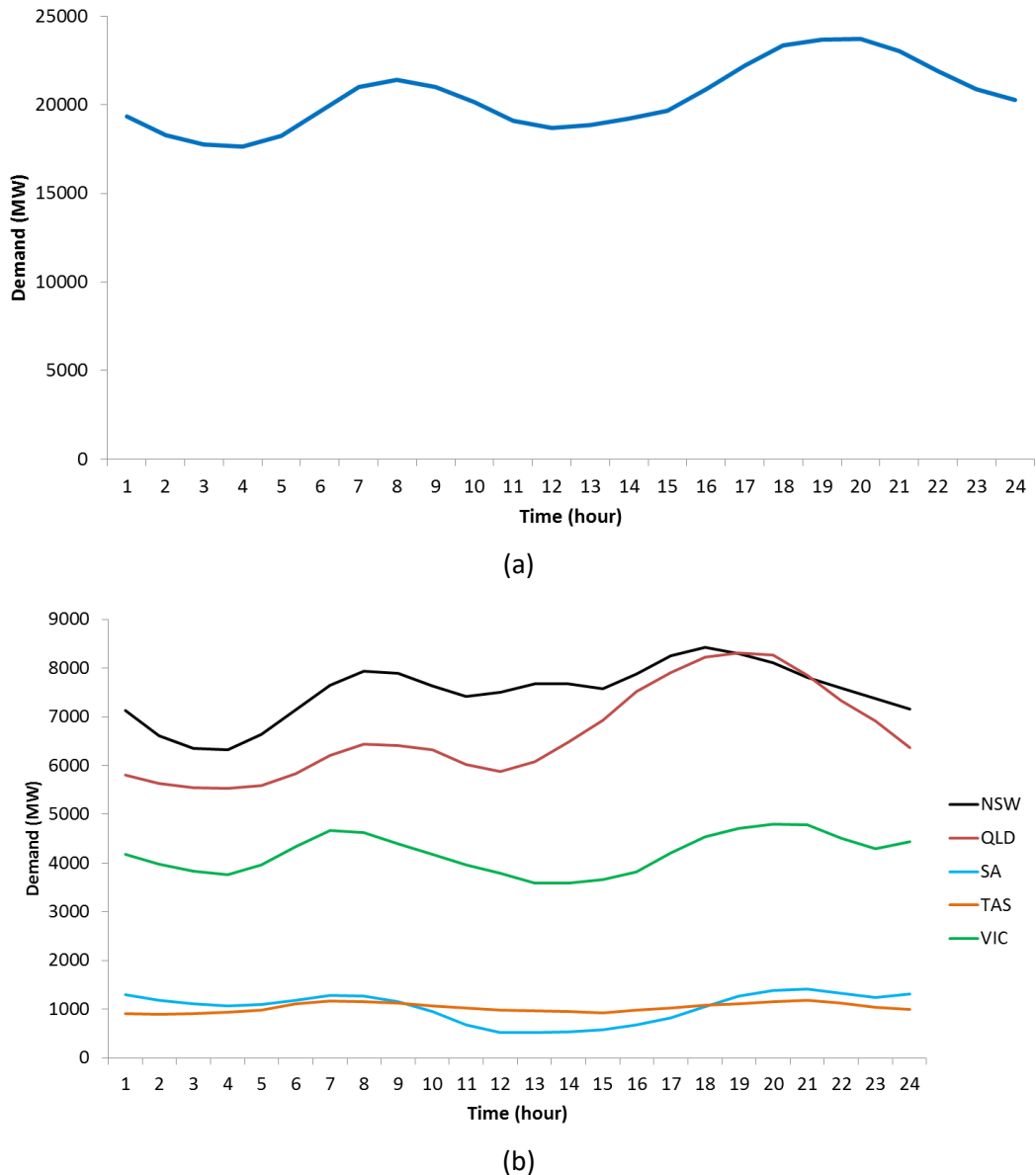

Figure 112. Current 24-hour load profile in Australia (on Tuesday, 19 January 2021[278]: a) Total b) States.

To show how the electrification of heating processes in the above-mentioned sectors may affect the characteristics of the current load both individually and totally, 7 cases are considered as follows:

### Case 1: Food and Beverage Industry

The annual thermal energy required for low-temperature (<math><150^{\circ}\text{C}</math>) process needs in the food and beverage industry is 46 PJ/year. Assuming the condition in which full electrification of heat can be achievable, the electrical energy for processes in ranges <math><150^{\circ}\text{C}</math> is approximated at 13,000 GWh/year, considering conventional electric boiler (Coefficient of performance, COP = 1). We consider COP=1 to show what would happen if the traditional boilers (COP = 1) are utilised. However, the total energy required could be reduced by using more efficient technologies such as heat pump with higher COP, i.e., 3 or more. There is no access to sufficient data related to the load profile of food and beverage manufacturers. Based on the survey conducted in the Market Status section of this report, the majority of subsectors of the food and beverage industry operate 24/7. Therefore, a typical load pattern closely fitting with food and beverage manufacturers' electricity consumption is selected considering these operating hours [279].

### Case 2: Alumina and Non-ferrous Metals Industry

The consumption of thermal energy for processes in ranges  $<180^{\circ}\text{C}$  in the alumina and non-ferrous metals industry is equal to 88 PJ/year. It should be noted that due to the lack of information on the thermal energy used for processes in the range  $150\text{--}180^{\circ}\text{C}$ , we suppose that all the energy used for processes in the range  $<180^{\circ}\text{C}$  fit into the range  $<150^{\circ}\text{C}$ . Therefore, with the assumption of full electrification, 24,000 GWh/year energy is required to address the potential heating needs of this industry. In addition, as mainly two-third of alumina refineries are in WA, only 33.3% of the electrical energy required for electrification is estimated to be modelled and investigated in the NEM.

### Case 3: Pulp and Paper Industry

The annual thermal energy needed for low-temperature ( $<150^{\circ}\text{C}$ ) processes in the pulp and paper industry is 2.5 PJ/year, which is equivalent to 700 GWh/year energy for a COP = 1. Referring to the Section 2.3.3, the pulp and paper factories operate 24/7. Therefore, the pulp and paper industry is assumed to follow a profile load with a constant value. Biomass provides around 50% of this sector's overall needs currently, so we should consider this renewable energy source in modelling the additional demand. It is evident that this industry does not consume significant electricity. The electricity consumption in each hour is estimated at 40 MW.

### Case 4: Wood and Wood Processing Industry

The consumption of thermal energy for processes in the range  $<150^{\circ}\text{C}$  in the wood and wood processing industry is equal to 3.4 PJ/year. Wood factories generally operate 24/7. Therefore, a constant load can approximately be considered to model them.

### Case 5: Hospitals

In hospitals, 6.47 PJ/year energy is required for the process with low-temperature heating ( $<150^{\circ}\text{C}$ ), i.e., water heating needs. Assuming the full electrification of the process heat in hospitals, 1,800 GWh/year electrical energy is consumed annually, which a considerable value. Using a typical load pattern for hospitals [280].

### Case 6: Hotels

For hotels, heating electrification opportunities for processes in the range of  $<150^{\circ}\text{C}$  contain water heating for different aims. Water heating energy needs in a year are estimated at 1.12 PJ/year, which is equivalent to 300 GWh/year electrical energy.

### Case 7: Residential Aged-care Facilities

The Australian residential aged-care residents' water heating energy need in a year is estimated at 0.51 PJ/year, which is equivalent to 140 GWh/year electrical energy. The water heating process at residential aged-care facilities is similar to residential communities, small hotels, or office buildings.

The electricity price varies with location, size of the industry, duration and specifics of contracts. For instance, small industrial units pay for electricity around three or two times the price larger industries pay. Contracts also have their own complexity and are the function of different factors such as fixed connection charges and peak demand charges.

In total, it is important to evaluate the additional electricity demand resulting from the electrification of process heat in the range of less than  $150^{\circ}\text{C}$  in all aforementioned industrial and non-industrial sectors. The maximum demand considering COP = 1 and COP = 3 is 26.5 GW and 24.7 GW, occurring at 8 pm. The minimum demand for COP = 1 and COP = 3 is 20.4 GW and 18.6 GW, occurring at 4 am.

The estimated peak demand increases compared to the current demand by 11.9% for COP=1 and 3.96% for COP = 3, whereas the estimated minimum demand of the power grid increases by 15.7% for COP = 1 and 5.24% for COP = 3.

### Transmission congestion

Unprecedented load growth as a result of the electrification of process heat could put pressure on the transmission network. In a competitive electricity market environment, an increase in electricity sales and various contracts can make extensive use of the transmission grid, causing them to be heavily loaded. However, the transmission network is constrained to transfer limits such as thermal and stability limits. Therefore, it is critical to make sure that the network is not operated beyond its permissible limits due to security considerations.

### Reliability

AEMO's objective is to maintain the power system reliability at a highly acceptable level to support affordability for Australian consumers while meeting zero-carbon commitments. System adequacy and security are two fundamental aspects of power system reliability. System adequacy is generally concerned with the existence of sufficient facilities within the system to meet load demands. These facilities are imperative to generate sufficient energy and transport the energy to the actual consumer load points through the associated transmission and distribution networks. On the other hand, system security is concerned with the ability of the system to respond to disturbances arising within the system. It includes conditions contributing to the loss of critical generation and transmission facilities at the extensive and local levels.

Figure 113 depicts air temperature change from 1910 to 2090 near the surface (nominally at 2 m height) in Australia. The figure includes the median (the central line) and the range of the change averaged over Australia from all models in three scenarios (RCP8.5, RCP4.5, and RCP2.6). It is evident that the median Australian warming increases in the future in all scenarios [281].

## Electrification & Renewables to Displace Fossil Fuel Process Heating

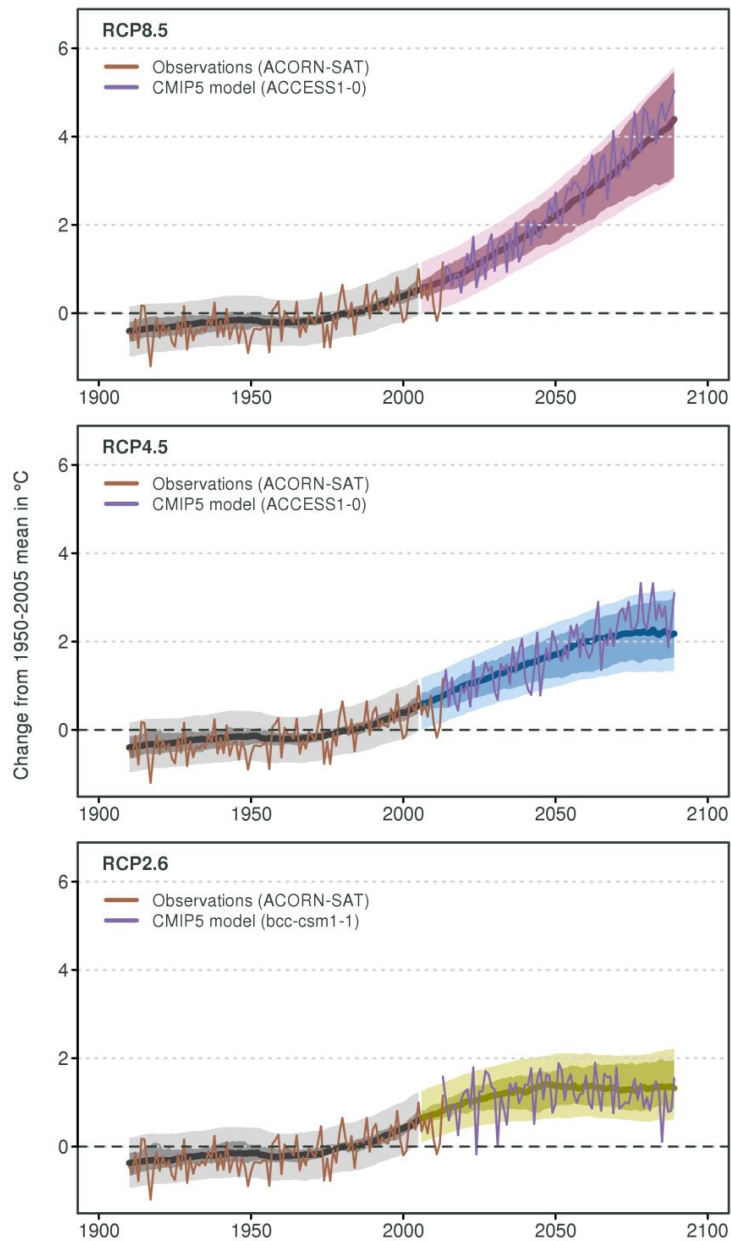

Figure 113. Time series for Australian average temperature change from 1910 to 2090 [279].

In addition to an increase in near-surface temperatures and long-lasting heat processes, electrification of industrial sub-sectors can put heavy pressure on the power grid reliability. The coincidence of industrial consumers' electricity uses with concurrent humid and hot days across Australia, particularly in critical regions and cities, may bring severe challenges for the power grid, making management and reliable operation of the NEM very difficult during coincident peak periods.

Prolonged heatwaves in general, and the crisis of increased bushfires in particular, are likely to make the power grid severely stressed, posing contingencies such as outages of generation or transmission facilities, affecting the power system's availability. These factors can contribute to a substantial increase in expected energy not supplied (EENS). As a result, any power loss, even for a short period, can bring negative economic implications for the power-dependent industry sector, which, in turn, may deteriorate the overall economy rapidly.

### Variability and intermittency of renewable energy sources

To meet Australia's overall decarbonisation target, the integration of renewable energy sources has accelerated in the electricity sector. Although the deployment of RESs is cost-effective and eco-friendly, it may create some challenges for the system operator. Variability and intermittency of renewable energy sources, such as wind power and photovoltaic solar power, occurring from seconds to minutes to hours, can make the balance of demand and supply harder to ensure. For example, when there are periods of low demand and high variable renewable generation, the system operator might resort to curtail variable renewable generation. Whereas variable renewable generation curtailment may help preserve a balance between supply and demand, its intensity and repetition conflict with the government's decarbonisation goals and policies. In order to iron out these challenges, an energy system with a higher level of flexibility is required. Flexibility is power systems' ability to respond to demand and supply fluctuations with proper power system reliability fulfilment. Therefore, operators need to create mechanisms for the adoption of flexibility sources such as demand-side management and energy storage systems in the power grid to increase the power system's flexibility.

#### 5.3.3.2 Cost and upgrades

With extensive electrification of industry subsectors, the reliance of industrial consumers on electric power systems increases dramatically. Industrial consumers expect power suppliers, utilities, and power system operators to generate, transmit, and deliver electricity efficiently. Therefore, it is evident that considerable incremental changes in electricity demand resulting from significant electrification levels in the industry sector highlight the need for additional infrastructures and upgrades at different power system levels, i.e., generation, transmission, and distribution.

At the distribution level, electricity utilities are expected to deliver a large amount of electricity to electrified industrial facilities. This will increase the need for additional delivery equipment, including the installation of new substations and feeders.

Unlike some industrial companies which prefer to install renewable energy units to supply their electric demand, others need to purchase their required electricity from large-scale renewable energy units which are located far away. In both cases, the installation of new transmission lines and additional infrastructures is needed to connect RESs to the grid or to the electricity end-users. Therefore, the required additional transmission capacity can be categorized into two primary levels: long-distance transmission lines and spur lines. The former mainly includes inter-regional, long-distance transmission lines making the flow and transfer of electricity between regions or areas possible. However, the latter, i.e., intra-regional spur lines, aims to connect new VREs such as wind turbines and photovoltaic units to the existing transmission network. These transmission lines are generally shorter than inter-regional lines.

At the generation level, deployment of the new additional sources that can provide sufficient generation capacity for the electricity grid, such as renewable energy sources, including wind farms or solar PV panels, is also required to satisfy the peak electricity demand.

Installation of every single additional new facility and any upgrades will not be incurred without any costs. It is believed that these additional costs imposed on the power utilities are generally recovered through utilities' users. However, it can lead to financial losses for industrial consumers.

### 5.3.3.3 Recommendation to overcome barriers in the electrical power grid

#### Opportunities with the electrification of process heat

As discussed earlier, decarbonisation and electrification, specifically industrial electrification, may cause several challenges, including construction or purchasing state-of-the-art industrial technologies required for satisfying the power demands of electrified consumers and additional upgrades in different levels of the power grid i.e., generation, transmission, and distribution networks.

Fortunately, the transition to electrification and the need for innovative technologies and resources that creating barriers can provide great remedies for the electricity grid if market and regulatory mechanisms are redesigned to address the new conditions.

Although the electrification of process heat inherently augments the heating processes' dependency on electricity, it could offer enhanced opportunities through load flexibility to manage peak demand and off-peak demand and provide ancillary services to the grid. Along with electrified heat processes in the industry sector, other heating sources which use renewable electricity such as boilers and heat pumps can help integrate more outstanding shares of VREs. Figure 114 shows the opportunities which can be acquired from the decarbonisation of heat electrification.

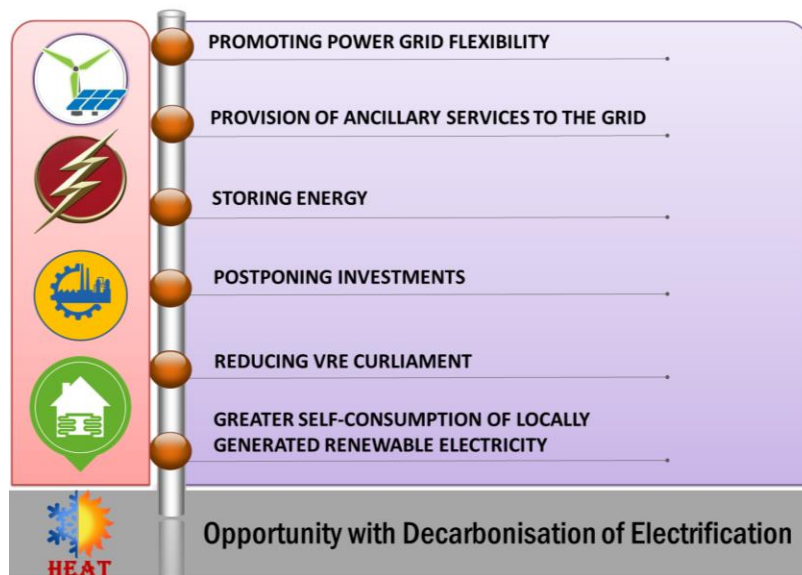

Figure 114. Opportunities with the electrification of process heat [282].

#### Promoting power grid flexibility

Increasing penetration of VREs can lead the supply to surpass the demand in some periods when the grid is not flexible enough, and curtailments are, therefore, needed to balance generation and demand. In order to avoid the curtailment of renewable energy generation, industrial electrified heating processes can be an interesting option to consume the excess electricity supplied from variable energy sources to satisfy their heating needs.

Compared to residential heat pumps, electrification of industrial processes heat can offer more active participation as resources of demand-side flexibility. These large electricity consumers with high flexibility potential can be activated through the time of use tariffs and price signals to respond and shift their consumption from peak periods (peak shaving) to off-peak intervals (valley filling).

### Provision of ancillary services to the grid

Industrial loads, characterised by their flexibility, can provide ancillary services to the grid, as well as aggregated residential heat pumps as follows:

- **Congestion Management**

Demand response resources have been considered as highly efficient and cost-effective tools for transmission congestion mitigation [283]. AEMO can ask industrial loads with electrified heating processes to participate in emergency demand response programs to help alleviate the existed congestion through curtailing their consumption in exchange for receiving incentives.

- **Improving Voltage and Frequency Stability**

Demand response can be used to enhance power system voltage stability [284] and frequency stability [285]. It can be performed in two ways: load curtailment and load shifting. For instance, with the system transformation, there are periods of low demand and high variable renewable generation, which may result in the curtailment of variable renewable generation, thus leading to higher system voltage and lower frequency. Minimum demand management is critical for maintaining system low frequency and managing high voltages. Electrified thermal loads with storage could be operated in a way to capitalise on negative wholesale market prices or just run when grid demand is low. Electrification-driven growth in electricity consumption resulting from the electrification of process heat in industrial subsectors and aggregated heat pumps can offer a great opportunity to maintain the power system stability and security.

- **Power Grid Reliability Enhancement**

As previously described, AEMO needs to take technically and economically efficient actions to meet the NEM reliability standard in the face of extreme conditions, which lead to potential supply shortfalls (an increase in the level of expected energy not supplied) at times of peak demand. There are different factors, including hot and humid days, prolonged heatwaves, and unexpected bushfires, that may impose challenging contingencies (generation or transmission facilities' outages) for NEM during peak times.

All these factors suggest the need for additional reserves in the system, which is necessary to be available during these circumstances. However, with electrification-driven load growth, there might be inadequate supply to fulfil the demand in some cases of failures in the generation, transmission, or distribution system's equipment.

AEMO has been reported to need to implement involuntary load shedding to keep the system secure and reliable during periods when the supply is insufficient to meet demand [286]. Although this strategy can diminish the risk of blackouts on larger scales, it is likely to bring publicly unsatisfactory consequences. Specifically, short-term disruption of the system can have substantial adverse economic effects due to the high reliance of the economy on the power grid.

However, with advancing technologies and digitalisation of the power grid, a set of demand response resources such as industrial subsectors, the so-called megawatt demand response firms (DRFs), have the capability of participating in demand response programs through advanced metering infrastructures (AMIs) to help improve the power grid reliability [283]. Therefore, electrification of heat over Australia can enable AEMO to rely on voluntary, price-responsive load reductions to achieve higher levels of reliability using embedded AMIs in the system. Increasing growth in distributed energy resources is also another option for AEMO to provide additional reserves in the system.

### Storing energy

In addition to buildings, industrial subsectors can be equipped with thermal storage systems to enable customers to respond to demand response programs using the stored heat during periods of peak electricity demand, thereby reducing the electricity demand on the power grid in critical conditions. Innovative smart storage heating solutions can be applied to both small, electrified heat consumers (e.g. residential heat pumps) and large-scale industrial consumers to take advantage of variations in electricity prices throughout the day.

With the increasing share of variable renewable energy sources such as solar and wind in the national electricity market, there may be periods of excess supply during the day that can contribute to lower electricity costs. Therefore, thermal energy storages can enable the industry sector to take advantage of the lower electricity costs in these periods. For instance, instead of consuming electricity during peak times for their process heat, they can use power during night off-peak hours (night) to produce heat and store it for later use during peak electricity demand intervals. Thermal storage systems can provide an opportunity to optimise heating costs for consumers, especially industrial users, and provide ancillary services as well as grid-balancing services to the NEM.

### Postponing Investments

Combined with decentralised installations of renewable energy sources and other distributed generations, smart demand-side management of large-scale power-dependent consumers can postpone the expansion of the generation and transmission systems.

Suppose industrial customers with electrified heat processes rely on local VREs for meeting their required power demand. In that case, the need for investments in additional long-distance, inter-regional transmission expansion, known as one of the critical requirements of electrification, could be mitigated. Nevertheless, the capacity of short spur lines for interconnecting new renewable energy sources correlates with the level of electrification.

### Potential of using additional solar power during daytime

The additional demand from the electrification of industrial process heat can be supplied by excess solar power generation during the daytime. The excess solar power can be utilised to meet the daytime additional industrial load demand due to decarbonisation. Advanced thermal storage has the potential to store surplus solar power, which can be utilised during peak hours. The energy market operator has confirmed in its latest quarterly Energy Dynamics report that the renewable energy curtailed in Q4 2019 was 6% of the total output [287]. Total electricity demand and total PV generation are shown in Figure 115. The utilisation of this excess solar power for the decarbonisation of process heat can save annual energy of 1270 GWh and significant economic value, which could lead to cost savings of approximately 254 million AUD per annum.



## Electrification & Renewables to Displace Fossil Fuel Process Heating

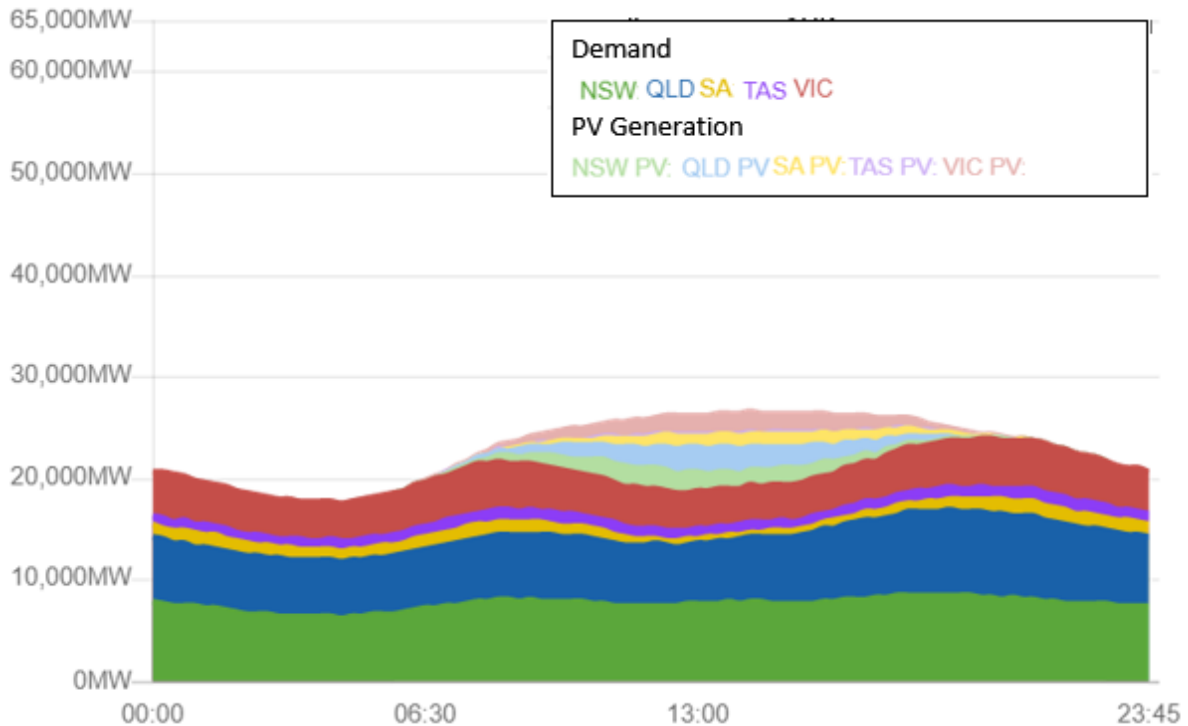

Figure 115. Total electricity demand in each state combined with the amount generated by PV. Source: [282]

### Case study

This section aims to derive the industrial and non-industrial demand response flexibility for the selected industry sectors as represented by Table 1. Due to insufficient information on the price of electricity for all sectors, only 4 sectors are selected for investigation, and some assumptions are made as follows:

- Two DR flexibility policies are considered: 1) Peak shaving and 2) Valley filling.
- The food and beverage industry can shift 20% of its whole load depending on electricity price.
- The flexibility potential of non-industrial sectors, i.e., hotels, hospitals, and aged-care facilities, is assumed 20 percent of their load.
- The development of information regarding off-peak, shoulder, and peak load electricity prices is based on the total estimated Australian grid's daily load profile after the electrification of high-potential sectors' process heat <math><150^{\circ}\text{C}</math> and the availability of the electricity price data for different sectors (Section 2).
- Using thermal storage and heat pumps can provide the opportunity of flexibility for sectors.

## Electrification & Renewables to Displace Fossil Fuel Process Heating

Table 35. DR flexibility opportunities for four sectors

Sector		Food & Beverage	Hospitals	Hotels	Aged-care
Electricity Price (\$/kWh)	Off-peak	0.04	0.1	0.1	0.1
	Shoulder	0.047	0.15	0.15	0.15
	Peak	0.09	0.2	0.2	0.2
DR Event	Flexibility (%)	20	20	20	20
	Peak Shaving Duration	5 pm-10 pm	5 pm-10 pm	5 pm-10 pm	5 pm-10 pm
	Valley Filling Duration	2 am-5 am 12 pm-1 pm	12 am-6 am 12 pm-1 pm	12 am-6 am 12 pm-1 pm	12 am-6 am 12 pm-1 pm
Daily Cost (\$)	Purchasing electricity (without DR)	2,170,000	770,000	139,000	63,200
	Purchasing electricity (with DR)	2,080,000	746,000	134,000	60,800
	Saving	88,300	24,300.01	5,300	2,410

Figure 116 shows the annual energy reduced by each sector during peak load hours of the power grid, i.e., 5 pm to 10 pm. The food and beverage industry has a more significant contribution than other sectors. Figure 117 represents the annual cost saving for each sector resulting from the implementation of DR flexibility programs.

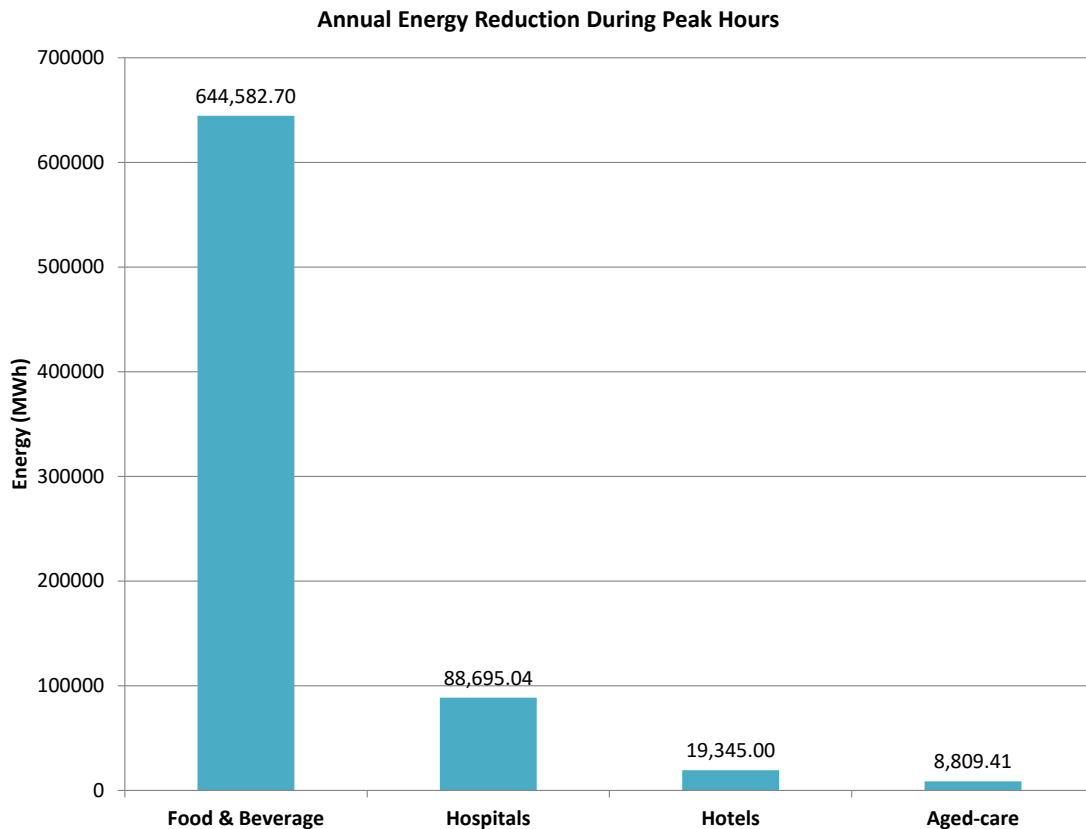

Figure 116. Annual energy reduction of each sector during peak load hours of the power grid.

## Electrification & Renewables to Displace Fossil Fuel Process Heating

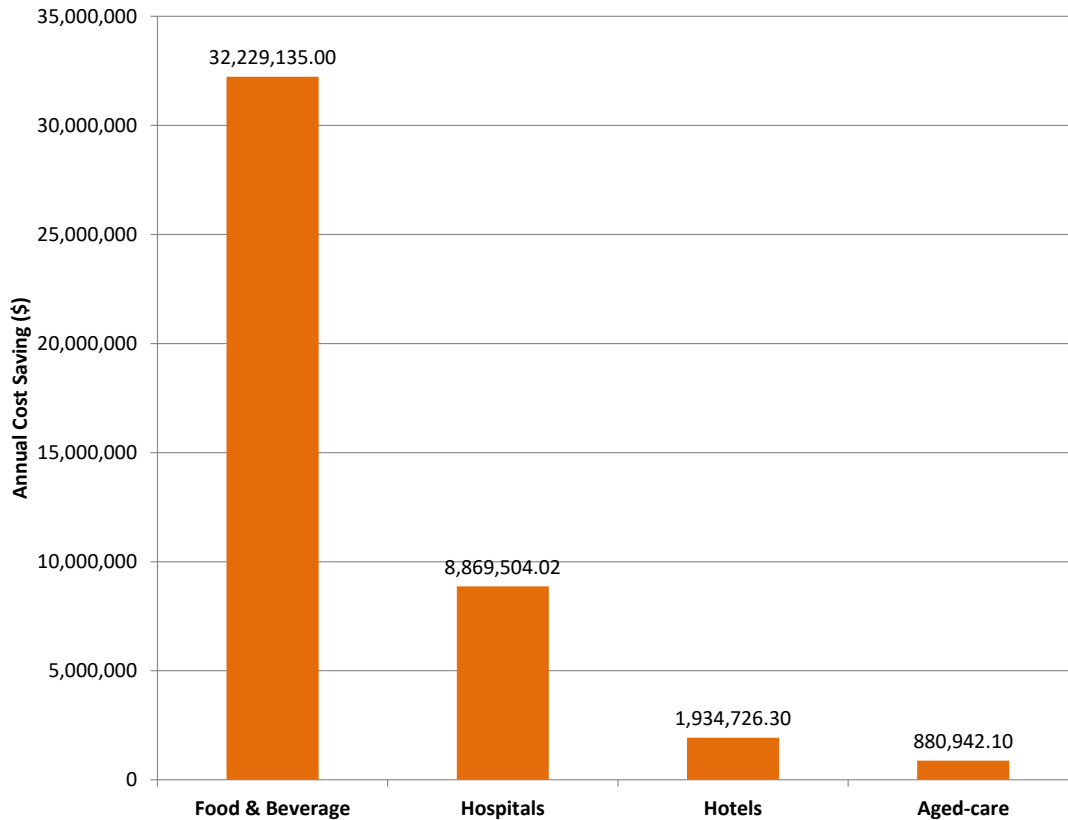

Figure 117. Annual cost saving for each sector after demand response.

The quantification of the impacts of process heat decarbonisation for the temperature range <150 degree Celsius on the grid is an approximation approach, where only boilers and heat pumps are considered as the potential electrification technology. However, using other technologies such as solar thermal could enable load shifting/clipping. Although grid integration of the industrial process heat will also increase total demand, however utilisation of thermal storage, peak shaving and valley filing can provide ancillary service to the grid and bring financial benefits to the grid operators and industrial customers.

### Level of hot and/or cold thermal storage requirement

According to the survey results, there is a lack of information to calculate the amount of hot and/or cold thermal storage requirement for all sectors of interest. Therefore, an approximate value of thermal storage requirement to minimise or avoid increasing peak demand is calculated for food and beverage, hospitals, hotels, and aged-care sectors using available data. Table 36 illustrates the level of thermal storage systems which can be implemented for potential sectors, during off-peak times to enable demand response through using the stored heat. In this context, to reduce the peak power demands, the aforementioned sectors employ thermal storage systems to store thermal energy during off-peak times (i.e., 2 am-5 am and 12 pm-1 pm) for later use over peak hours. The level of storage in respect of MWh and GJ for each sector is provided in Table 36. As can be seen, the daily thermal energy stored for food and beverage, hospitals, hotels, and aged-care sectors is 1770 MWh, 243 MWh, 53.0 MWh, and 24.1 MWh respectively.

## Electrification & Renewables to Displace Fossil Fuel Process Heating

*Table 36 The level of thermal energy storage for the case study*

Sector		Food & Beverage	Hospitals	Hotels	Aged-care	
Time (hour)	2 am	Increasing demand (MWh)	294	43.9	7.56	3.44
		Thermal Energy Stored (GJ)	1060	158	27.2	12.4
	3 am	Increasing demand (MWh)	294	42.5	8.64	3.93
		Thermal Energy Stored (GJ)	1060	1537	31.1	14.2
	4 am	Increasing demand (MWh)	294	41.2	9.18	4.18
		Thermal Energy Stored (GJ)	1060	148	33.1	15.1
	5 am	Increasing demand (MWh)	294.33	39.2	9.72	4.42
		Thermal Energy Stored (GJ)	1060	141	35.0	15.9
	12 pm	Increasing demand (MWh)	294	38.5	9.39	4.28
		Thermal Energy Stored (GJ)	1060	139	33.8	15.4
	1 pm	Increasing demand (MWh)	294	37.8	8.53	3.88
		Thermal Energy Stored (GJ)	1060	136	30.7	14.0
	Total (daily)	Increasing demand (MWh)	<b>1770</b>	<b>243</b>	<b>53.0</b>	<b>24.1</b>
		Thermal Energy Stored (GJ)	<b>6360</b>	<b>875</b>	<b>191</b>	<b>86.9</b>

### 5.3.4 Regulations, policies, and standards

#### 5.3.4.1 The National Electricity Market and the demand response mechanism

Load flexibility in Australia was till recently not yet supported by any implemented mechanism, other than some trials [288]. The current market and regulatory framework makes it difficult for electricity consumers to realise value from it [288].

AEMO manages the process of electricity trade in the national electricity market (NEM) between generators and retailers through the spot price mechanism which determines the wholesale price of electricity in each 30-minute interval [130]. The minimum electricity price is ensured by AEMO's ordering of the generators' offers from the least to the most expensive in each time interval, so that the electricity demand is continuously met at the settled spot price [289]. The NEM spot market has actually started in 1998 [289], and it was structured in a way so that its financial markets could mostly convey the physical status, requirements, and constraints of the physical electricity system with the least interference from AEMO [290].

With the national electricity system undergoing such an immense change as underlined previously [291], a lot of challenges are anticipated for AEMO to maintain the proper operation, security, and stability of the electricity system as well as the economic effectiveness of the related electricity market. This is mainly due to the fact that VREs and DERs are characterised by an uncertainty of supply as opposite to dispatchable-based power stations [291]. Higher system voltage and lower frequency

would then be experienced when generation exceeds demand (i.e. curtailed energy), which would drive AEMO to interfere in the financial market through the procurement of ancillary services (e.g. voltage and frequency control) [290]. Minimum operational demand is also critical for maintaining system security such as system strength and inertia, while maximum demand management for maintaining reliability. Additionally, the wholesale electricity spot price in the NEM is no more reflecting the economic value of generation as non-dispatchable renewable energy generators have zero marginal costs for energy production differently from the fuel-based dispatchable generators [287].

- ❖ *How to overcome this barrier: A “two-sided market”, that is a market reform planned by the Energy Security Board in Australia [288], with wholesale demand response mechanism as part of it, and where large consumers such industrial loads (i.e. electrified heat process), through their load flexibility, can participate and play a part in it.*

Market regulation mechanisms are currently under restructuring to adapt to this change [287, 292]. Options such as demand response (i.e. through load flexibility) and active distributed energy management are considered with effective pricing mechanisms [287, 293, 294]. In fact, demand response can respond to signals and help avoid required costly interventions by AEMO in the market when supply and demand are not balanced. Practical examples in Texas, USA, of how such an industrial response, can provide fast ancillary services (e.g. frequency management) have been highlighted in [295] as per Figure 118. Actually, Texas has a considerable growing capacity in wind energy [296].

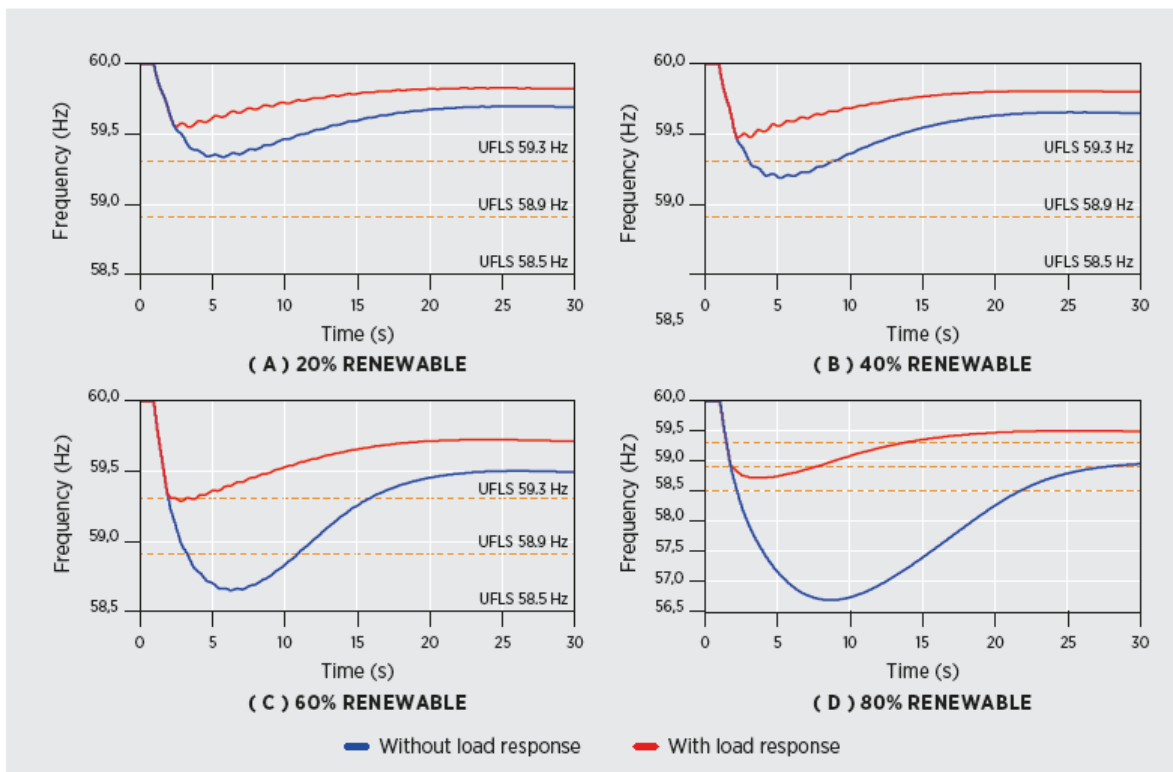

Figure 118. Example of an industrial demand response providing fast frequency response in the Electric Reliability Council of Texas (ERCOT) under different penetrations of renewable energy, as included in [295]. Source: [297]

Advanced intelligence in the networks and enabling technologies [298] that can get the appropriate insight of various resources, send price signals, and value flexibility, would then be required [295].

In this respect, The Energy Security Board (ESB), within a post-2025 market design [288], has set the trajectory for a “Two-Sided Market”, with a focus on an engagement of a flexible two-way supply and demand resources, as well as scheduling, ahead mechanisms (e.g. day-ahead market), and DER integration in the supply chain.

As part of this direction, the Australian Energy Market Commission (AEMC) has issued a rule change in June 2020 [299] allowing large electricity consumers (i.e. industrial, commercial, etc.) to sell demand response in the NEM, either directly or through an aggregator (i.e. demand response service provider (DRSP)). Such consumers would change their demand following price signals, and get a financial return for that [300, 301]. The interaction among different parties involved in this process is highlighted in Figure 119. The rule will be implemented in October 2021. It will also be preceded by another rule change in this direction, to be applied in July 2021, that aims to shorten the time interval of the wholesale electricity market from 30 minutes to 5 minutes [302]. Such shorter interval would better reflect the status of the electricity network particularly when highly fed by renewable intermittent generation.

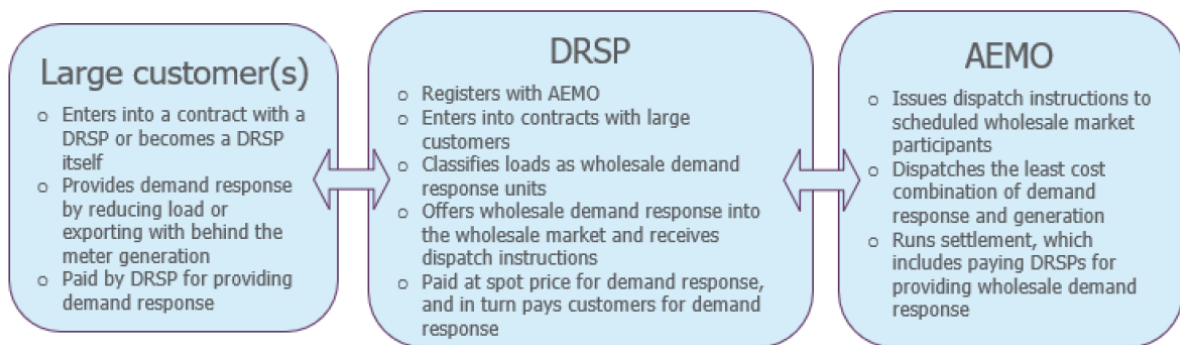

Figure 119. The process of the demand response mechanism as set by AEMC [299]

In the frame of valuing the demand response, also known as flexibility, in the process of Figure 119, a baseline energy is defined and additional consultations for a proper dynamic calculation of it will take place [301]. The DRSP will be paid by the retailer, if involved, the spot price of the energy difference between the baseline and the metered energy, which is the dispatched demand response, when this is positive. The vice versa flow of finance occurs when this is negative. The consumer is paid by DRSP for demand response according to a commercial agreement between the two parties, while the retailer is compensated by DRSP with a reimbursement rate for it.

Industrial customers, with electrified heat process, particularly those that can schedule their operation flexibly or use storage can take advantage of such mechanism [277, 303]. It is also worth to examine the additional potential economic benefit if this is coupled with a renewable PPA as per current availability [304]. The advantage of industrial electrification accompanied with demand response has also been recognised internationally, particularly in Europe and the United States [295, 305].

#### 5.3.4.2 Regulations for connection to the grid by large electricity consumers

A connection to the grid by a large electricity consumer (i.e. industrial), or an upgrade to a relatively much larger load, usually requires a non-standard process in Australia (i.e. negotiated services) that is currently deemed complicated, costly, and time-consuming as for the following reasons [306, 307]:

- A detailed study of the network (i.e. strength, reliability, etc.) will be performed by the distribution network service provider (DNSP) based on a full design, execution, and

commissioning plan which has to be prepared by the customer. In fact, the network capacity needs to be considered based on the peak demand of the customer, and consequently, a change or upgrade in the network infrastructure and assets (i.e. transformers, lines, etc.) will probably be required [307].

- The site will have to be de-energised by the DNSP if any upgrade work is to happen, particularly at the connection point, such as an upgrade in the existing service line, etc. [307].
- Based on the amount of network-upgrade work, the time to execute and commission such changes could range between 1 and 2 years once the application is approved. The latter (i.e. application) would take between 4 and 12 months. In fact, the process involves multiple steps and parties (i.e. customer, electrician, retailer, DNSP, metering provider) and the timeline can be subject to multiple delays at different administrative nodes [306].

The upfront cost (i.e. that is not recovered through network tariffs) borne by the customer, was recently estimated by Energeia [306] to be on average at around 60,000 AUD for a relatively large low-voltage connection, taken a large sample of recent cases with multiple DNSPs. The exact amount would vary depending on the individual case based on the network-upgrade work. Additionally, the electricity customer would also incur higher fixed annual tariffs charges, and higher monthly maximum demand charges.

- As per the current network policy, customers are not allowed to install a second or more metered points for sub-loads, though the rules do not forbid that. DNSPs relate this limitation to IT technical difficulties [306]. This would imply that a new connection with a separate National Metering Identifier (NMI) needs to be assigned for each of such sub-metered loads and consequently, additional access charges along with annual fixed network charges to the customer would result. For instance, for a new connection with 200 MWh per annum, an additional cost of annual fixed network tariffs at approximately 3,700 AUD would be borne by the customer according to current DNSP schedules taken by Energeia [306].

❖ *How to overcome this barrier: A streamlined process and enabled sub-loads network metering policies*

A streamlined process that targets reduction of processing time for new and upgraded connections by large customers (e.g. industrial) would be required to overcome this barrier. Additionally, providing metering services for sub-loads shall be possible at relatively a small incremental cost (i.e. not that of an equivalent second connection), particularly that the additional cost for this would just be related to data-processing [306]. Sub-metering enables industrial customers to better engage in demand response mechanisms with sub-loads flexibility's potential, and to reduce peak demand level.

Additionally, a review of tariff-restructuring including peak demand charges, particularly for industries, to adapt to the potential opportunities in electrification of process heat, would also be needed as part of overcoming this barrier.

### 5.3.4.3 *Regulations for DER connections to the grid and integration*

In case of development of onsite renewable energy generation for electricity supply to the suggested technologies (for electrified processes), similar procedures and costs as described in the previous section (load connection by large customers), apply here when the onsite generation size (i.e. DER such as PV w/wo storage) does not exceed 5 MW and is registered as an embedded generator (i.e. not registered with AEMO as an electricity generator) [308]. The impact on the network, and consequently on the procedures and costs for this connection, would depend on the maximum power and energy that the DER will exchange with the grid.

However, in addition to that, networks currently do not allow DER to be installed with a separate connection. The system can currently be connected as a sub-level connected device, with its own meter as shown in Figure 120, but not with its own NMI [306]. This would inhibit the DER to provide grid services as part of DER integration in Post-2025 Market Design of Energy Security Board [288].

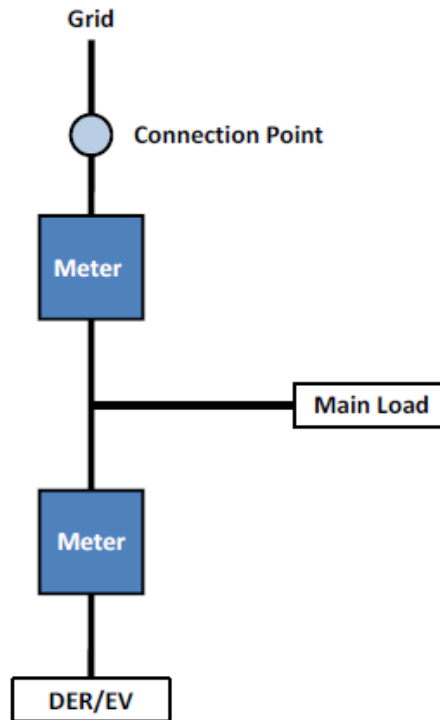

Figure 120. Connection of DER as per current network rules

- ❖ *How to overcome this barrier: Allowing better DER integration at reflective costs accompanied with streamlined processes*

Allowing a separate metered connection (NMI) for a DER system is seen as an enabler for DER integration in the electricity network [306], particularly for industrial stakeholders. As in the case of a load connection to the grid, a second connection shall not add a significant cost [306]. This shall be accompanied by streamlined processes for DER connections.

#### 5.3.4.4 Reliability standard for the grid and Values of Customer Reliability

Some industries or processes could be sensitive to blackouts, even for a short time. Gas has been seen since a long time as a reliable fuel where its supply can be continuous and guaranteed. The perceived unreliability of the grid or of any onsite renewable system may pose a major barrier towards electrification of process heat. In fact, as per the reliability standard for the grid, at least 99.998% of forecasted demand needs to be met yearly, while the “Values of Customer Reliability” (VCR) review, that is surveyed each year, reflects customers’ perception of reliability in multiple regions [309]. Due to controlled load shedding events that happened in Victoria in 2019 during extreme heatwaves, the reliability standard was not met [309] (Figure 121). In fact, controlled load shedding is instructed by AEMO when the demand exceeds the maximum supply capacity in the network, and thus complete



## Electrification & Renewables to Displace Fossil Fuel Process Heating

system-blackout is avoided by rolling on supply interruption through groups of customers for half an hour each for example.

Power interruptions also occur majorly (as 95.6% of all blackouts) because of local network and technical problems, such as equipment failure, knocked pole, or damaged power lines in bushfires [309].

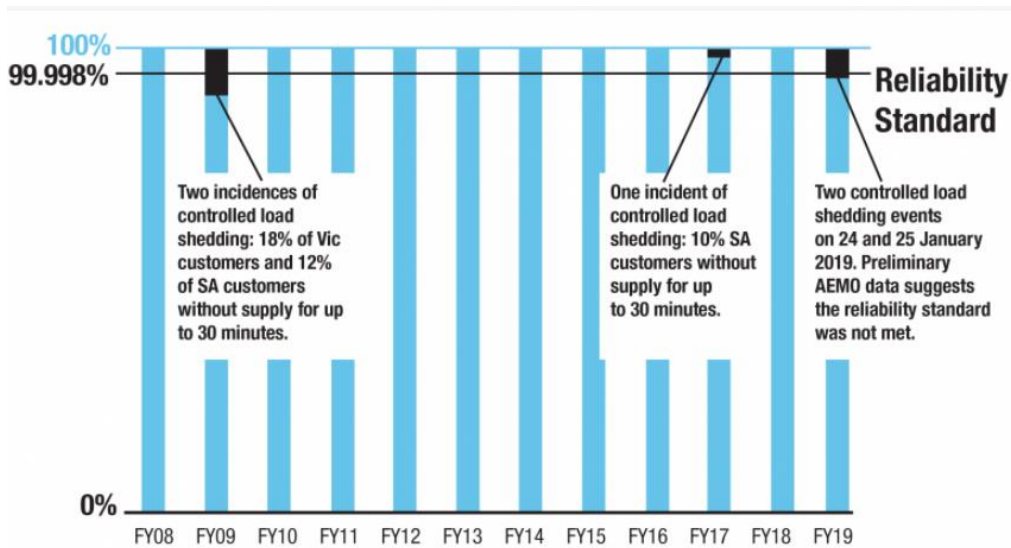

Figure 121. Controlled load shedding as occurred in previous years in Australia [309]

- ❖ *How to overcome this barrier: To improve customer reliability value by ensuring a high reliability of the network*

A high customer's perception for the grid reliability can facilitate the change towards industrial electrification of process heat.

To improve the value of customer reliability (VCR), particularly for industrial electricity customers, increased measures in the following directions are beneficial:

- In addition to the continuous maintenance of equipment and investment in distribution reliability made by networks, the reliance of AEMO on the emergency reserves using the market's reliability and emergency reserve trader mechanism (RERT) under the National Electrify Rules (NER) rather than on controlled or forced shedding is much preferred. In fact, the RERT is a strategic reserve (standby capacity) AEMO can gain by paying a premium to signed-up customers who are called to decrease their demand in case of emergencies [309].
- On the other hand, industries could maintain back-up systems particularly for critical loads.
- Additionally, increasing the use of on onsite and standalone renewable generation systems, particularly in areas that are highly exposed to bushfires is advisable.

### 5.3.4.5 *Mandatory Renewable Energy Target (MRET) – no thermal energy requirement – and lack of carbon pricing mechanisms*

As a background, the mandatory Renewable Energy Target (RET) commenced in Australia in 2001 as a response policy from the federal government to climate change. It has been later developed with the aim to have a Large-scale Renewable Energy Target (LRET) of 33,000 GWh in 2020 sourced from large-scale renewable generators (approximately 20% of total energy supply), and a Small-scale Renewable Energy Scheme (SRES) that is “uncapped” [310] (mainly including small renewable systems for

electricity generation and hot water). The above is achieved by providing subsidies to large-scale renewable electricity generators in the form of issued certificates that are tradable, known as Large Scale Generation Certificates (LGCs), while subsidies are provided to small prosumers of renewable energy in the form of Small-scale Technology Certificates (STCs). On the other hand, large energy users are required to buy a proportion of LGCs and STCs based on their energy use and surrender them to fulfil their RET obligations [311]. The renewable energy target has then been increased by different states for future years (after 2020) as states' policies. For instance, it has been set to be by 2030 at, 50% as Victorian RET, 60% for NSW, 50% for Queensland and Northern territory, 100% for ACT, with above 100% for South Australia and Tasmania to support renewable hydrogen production [312, 313].

In fact, the main aim of the RET is to encourage renewable energy investments for electricity generation and reduce greenhouse gas emissions [314, 315]. However, it does not put a renewable generation target for heat or an incentive to electrify it.

As another relevant policy for de-carbonisation, the carbon pricing scheme or "carbon tax" was introduced by the Australian government in July 2012 to meet the international obligations for climate change (Kyoto protocol), and that put a carbon tax on polluters for every tonne of carbon dioxide they would release into the atmosphere [316]. This was also an attempt to control the country's greenhouse gas emissions and foster developments in clean technologies through the creation of related assistance and investment programs such as the Clean Technology Program, the Steel Transformation Plan, and energy efficiency measures. The "carbon tax" is actually seen as an effective mechanism towards decarbonisation, and is considered or adopted internationally [317].

The Australian Federal Government abolished a "carbon tax" concept in July 2014, seeing it as causing a raise in energy prices [318]. In its place, an "Energy Reduction Fund" has since been created to provide incentives to a range of organisations to reduce emissions by giving them the possibility to earn Australian carbon credit units (ACCU) for emissions reductions. Those carbon credits can be sold to the government or secondary market for a financial return [319]. However, the carbon pricing mechanism is still seen as the most effective and widely adopted one [317].

❖ *How to overcome this barrier: Re-introduce a carbon pricing mechanism that can co-exist with thermal energy requirements in relation to the Renewable Energy Target*

Introducing a price on carbon which includes domestic as well as imported goods would be a way that could drive the change towards fossil fuel displacement in industrial process heat. The revenues from the "carbon tax" can be used to fund investments and technologies that displace fossil fuels, such as in industries and others [320].

This is also a way to get aligned with the international efforts in this respect. In fact, it is expected that the international directions would be to impose carbon border charges (carbon boarder tax adjustment) on imported products that do not have a carbon price [317]. In these directions, not implementing a mechanism for carbon pricing in Australia, the latter would be at risk of having tax imposed by other countries on its exported products, which would be a more costly scenario for the Australian economy.

On the other side, adding thermal targets in the RET for electrification or thermal renewable generation, would also work towards de-carbonisation of heat and displacement of fossil fuels (i.e. gas), particularly in process heat towards either electricity or thermal-renewables (i.e. solar-thermal, etc.).

### 5.3.4.6 Standards and codes

Lack of Australian standards particularly with regard to high temperature heat pumps, MVRs, etc. for industries as well as of related Australian energy efficiency standards for process heat could be seen as a barrier. This presents a lack of standardisation and supportive guidelines to switch to these technologies in industries.

Additionally, With respect to commercial buildings, energy efficiency codes [321], as well as energy rating systems for buildings (i.e. NABERS) with area larger than 2000 m<sup>2</sup>, have been mandated [322]. However, there has not been preference of one source of energy (i.e. electricity) over another such as gas, particularly in relation to water and space heating [321]. Nevertheless, a trajectory for buildings of net zero annual energy use (NZRE) and onsite renewable energy (that could offset gas) was set. Some feedbacks to it tended towards supporting electrification of heat in buildings. For, instance, a local government in metropolitan Sydney, in its submission for the Australian Building Codes Board (ABCB), stated [323]:

*“We question the allowance for gas in both the ABCB options as it is incompatible with the stated objective to save energy costs and emissions. In most states, the use of electric heat pumps provides a more efficient and better value outcome, even when measured only against 2019 emissions and cost parameters... The allowance for gas in Option 1 is fundamentally incompatible with the Net Zero Energy requirement. On-site renewable energy can only offset electricity usage on a kWh to kWh basis. The generation of on-site electricity cannot be used to offset gas under any recognised greenhouse gas accounting or reporting standard, including the Australian National Carbon Offset Standard. Option 1 therefore requires all electric regulated services”.*

- ❖ *How to overcome this barrier: Standards development for such new technologies and mandating related standards for energy efficiency in industries*

The following is proposed as a way for related new technologies to enter the market, provide technical support to adopters, and reduce the barriers:

- Development of Australian standards for such new technologies (i.e. high temperature heat pumps, etc.) [324], and best practices.
- Revising and mandating energy efficiency standards in industries.
- Development and application of regulatory measures for onsite renewable thermal energy generation and thermal storage [325].
- Considering the adoption of electrification of heat in buildings by ABCB as part of NZEB trajectory [323].

## 5.4 Knowledge, Skills, Tools, Training, Accreditation and Culture

As indicated in the technology review, many non-fossil fuel heating options are at a high TRL/high CRL and see high adoption rates in some areas, for example biomass in the sugar, pulp and wood industries. Small-scale solar thermal collectors and heat pumps are not new in Australia having been used in residential and commercial operations for many years with well-developed supply chains for those sectors. However, several high TRL technologies such as industrial heat pumps and industrial solar thermal, have not seen wide adoption in Australia despite wide adoption in other markets such as Europe and Japan. This is partly due to a low appetite for risk, generally fewer/lower policy financial incentives than for other technologies, Australia’s climate, and high electricity prices as a ratio of natural gas and coal, giving rise to high financial barriers. Lower TRL technologies have low levels of

awareness, knowledge, skills and immature, fragmented supply chains, as expected given their low levels of implementation in Australia. This section significantly draws from the IRG discussions and the industrial experience of A2EP as an Australian, multi-partner organisation in the space of energy productivity, with a specific interest in process heating [118, 236, 263, 270, 326, 327]. The section focusses on industrial heat pumps given their high TRL yet high knowledge, skills, training, and cultural barriers. However, each of these factors will be relevant to other, similar and lower TRL technologies.

### *5.4.1 Knowledge needed for the transition to non-fossil fuel heating technologies*

When implementing a non-fossil fuel-based heating project, the complexity and up-front costs are increased 5-fold or more when compared to traditional heating systems, e.g., steam boiler as seen in the A2EP renewable energy process heating program through 2019 and 2020. The well-established supply chains for fossil fuels and the low cost of systems for turning fossil fuels in to useful heat provide a low-risk, well-proven, easy path for heating. Traditional heating solutions are typically designed as a stand-alone, centralised utility that is sized for peak loads and is always available. Successful implementation of a non-fossil fuel alternative needs to take a holistic approach to optimise capital and operating costs and therefore reduce real and perceived financial barriers. Non-energy benefits should also be considered and accounted for. A culture of expecting short payback periods, applying high discount rates to future savings, and ignoring ‘multiple benefits’ means higher up-front costs, regardless of long-term benefits, is a major barrier. The design also needs to consider the potential for decentralised heating, the potential intermittent nature of the heat supply, ways to reduce peak loads, and the potential benefit to load flex in response to the electricity grid or behind the meter conditions. The end-user also needs to manage the risk of dealing with a different supply chain and contractors outside of most businesses’ networks of “trusted contractors”. The approach to non-fossil fuel heating requires a different set of skills to a traditional heating project, as expanded below.

#### *Understanding of the applicability of different technologies and related performance characteristics*

This critical detail is currently only well known among the major heat pump manufacturers, industrial refrigeration contractors and a few specialist energy consultants. End-users, general manufacturing consultants and contractors have very little understanding of the different technologies and their performance characteristics and capabilities. In contrast, they are very familiar with gas technologies. So knowledge, perception of professional risk and allocation of time to reskill are challenges.

#### *Optimising energy efficiency, heat recovery and heat sources to optimise non-fossil fuel heating technologies*

As mentioned above, a non-fossil fuel heating technology will typically have a CAPEX many multiples more than traditional fossil fuel solutions but with potentially much lower OPEX, even if ignoring future potential carbon taxes. Return on Investment (ROI) and Internal Rate of Return (IRR) for non-fossil fuel technologies may be higher than for traditional solutions, and payback periods shorter. To help bridge the gap in the CAPEX, it is essential that the peak demand and therefore heating equipment sizing is minimised by first optimising heating demands with an energy efficiency and heat recovery audit. Energy efficiency improvement should reduce heat losses, system leaks, etc. while heat recovery should minimise the heat of products and by-products leaving processes. Only after this is done, should optimisation of heat sources for technologies such as heat pumps be considered. Energy storage usually plays an important role to smooth demand and limit the heat pump capacity required. This adds an extra dimension of complexity but can also bring benefits such as flexibility.

Optimising heat sources requires a good understanding of processes and heat flows and was noted as a failing in several studies done under A2EP’s renewable energy process heating program of feasibility

assessments. It was revealed in the first phase of the program that energy consultants often did not understand the best way to reduce energy consumption and tap into waste heat energy sources to drive heat pumps. Before the second phase commenced, participating energy consultants were trained in the pinch analysis methodology and each site investigation included this methodology. It was observed by the program steering committee that the quality of investigations increased tremendously after this training. It was also observed that mapping energy flows either with a basic Sankey diagram or via a process flow diagram, with a mass and energy balance yielded a far better understanding of energy flows and therefore, the ability to size and cost alternative heating technologies.

Optimising the use of heat sources often requires thinking outside the box or operations site as it were. For example, tapping in to heat from sewer mains to provide a constant heat source can greatly improve the financial viability of heat pumps given the sewer mains near constant all year-round temperatures. Another under-utilised opportunity is using waste heat from air compressor systems.

Utilisation of the cold created from a heat pump, either for space cooling or product cooling is also essential to achieving an optimised design but this is rarely done.

Only very few Australian energy consultants, technology providers and end-users have knowledge of such advanced energy/heat/water recovery practices. Industrial refrigeration contractors are adept at integrating heat recovery when the heat source for the heat pump is an industrial refrigeration system but often have a limited understanding of heat integration beyond the refrigeration plant. The vast majority of consultants, contractors and end-users are in need of further and on-going training in this area. Universities and vocational education organisations do not seem to provide sufficient skill development in this area.

### [Sizing for peak loads and understanding of thermal battery design, costing, and operation](#)

Whilst hot water tanks and steam accumulators are not new, the correct sizing and operation of these are not well established when considering the optimisation of heat pump selection and optimisation of COP. Understanding of the performance characteristics of high-temperature thermal batteries such as concrete or hot rocks are not well known due to the low implementation rate in Australia. Conscious management of energy storage in part-processed product (e.g. cement clinker before grinding) is also unusual in Australia.

### [Business case methodology](#)

Transformative changes from non-fossil fuel-based heating requires a new approach to business case development that must include productivity benefits, non-energy benefits, maximising on-site renewables, potential to optimise energy through wholesale market exposure and the applicability of grants and certificates. If a new heating project can unlock higher production capacity or higher yield, then these benefits will typically easily outweigh the higher capital costs. An example of a non-energy benefit would be a heat pump solution integrated with the refrigeration plant which will reduce the net amount of heat rejected by the refrigeration plant. If this heat is normally rejected to a traditional cooling tower, then integrating a heat pump will reduce the amount of water used in the cooling tower, which will in turn reduce the amount of wastewater and chemicals consumed as well as potentially giving lower electrical consumption of the cooling tower fans and/or freeing up cooling tower capacity to allow production increases. Furthermore, if the heat pump is integrated at the design stage there could be a reduction in the CAPEX of the cooling tower and ancillaries. Other non-energy benefits such as reduced health and safety risk from not using steam systems, higher employee

comfort by utilising the heat pump coolth for factory space cooling or improved production flexibility with thermal storage all contribute to the business case.

The holistic engineering approach needs to be coupled with a holistic financial approach to consider issues such as: white certificates, Australian Carbon Credit Units, government grants, on-site renewable usage, electricity tariffs as well as participation in demand response markets and possible revenues.

Finally, with the emergence of potential carbon border levies, the future carbon emission impact of the chosen heating solution needs to be incorporated into the business case. Major companies are also increasingly looking at reducing Scope 3 carbon emissions – from upstream and downstream of their business through performance requirements and reporting. So many manufacturing plants will face increased pressure to cut emissions from their customers.

### Design, installation, and maintenance of customised heat pump systems

The design and installation of an industrial heat pump are very similar to an industrial refrigeration plant, which is a well-developed and competitive industry with good coverage across Australia. As such, this is not seen as a major barrier to further adoption in Australia. However, refrigeration specialists will require some transitional training and support to cover the nuances of heat pumps and also to understand the integration of heat pumps “across the pinch” so that the heat pump is not installed just as a “boiler substitute”.

### Component supply and support

Major global suppliers of industrial heat pumps have been supplying industrial refrigeration solutions in Australia for many years and are well established. Knowledge, skills, and training are not deemed to be deficient in this area however some suppliers have been operating a sales desk rather than a design service which does adversely affect the overall solution and business case. Several lower TRL options for non-fossil fuel solutions are not well represented in Australia with the notable exception of emergent PV-Thermal technologies which are being locally developed.

#### *5.4.2 Current skills inventory for main non-fossil fuel heating technologies*

This skills inventory summary, Table 37, largely follows the current installed base of each technology. The exception being heat pumps due to the close relationship with industrial refrigeration plants which are widely adopted across many industries already.

## Electrification & Renewables to Displace Fossil Fuel Process Heating

*Table 37 Skill inventory for high TRL technologies*

Skills for high TRL technologies	Advisory	Engineering & construction	End user operations & maintenance	Supply chain
Biogas				
Biomass				
Solar thermal – small-medium scale				
Solar thermal – large scale				
Heat pumps				
PV - thermal				
Hydrogen				

Low    Intermediate    High

### 5.4.3 Current skills inventory for each success factor across each market participant

Table 38 summarises the skills inventory across the major participants in a non-fossil fuel heating solution, that being; advisory or consultant engineering, engineering and construction or general contracting firms, industrial refrigeration contractors, end user’s on-site operations and maintenance personnel and participants in the supply chain, i.e., equipment suppliers as observed in A2EP’s renewal energy process heating program.

*Table 38 Skill inventory in non-fossil fuel heating solutions*

Skill	Advisory	Engineering & construction	Industrial refrigeration contractors	End user operations & maintenance	Supply chain
Technology awareness					
Technology performance characteristics					
Identifying and optimising heat recovery and heat source options					
Optimising heat pump selection and thermal batteries					
Business case development					
Design, installation and maintenance					

Low    Intermediate    High

#### Advisory

Several energy advisory consultants have had multiple experiences with alternative technologies after participating in A2EP’s renewable energy process heating studies program. This includes companies such as Energetics, pitt&sherry, Deta, NorthmoreGordon and 2XE. Knowledge sharing activities undertaken by A2EP in conjunction with this program have further expanded awareness to at least 15 other specialist energy consultants. However, this program was primarily investigated on the food and beverage sector (excluding the dairy industry). Several other sectors have not had broad exposure to alternatives such as; mineral processing, oil and gas extraction, gas transmission, iron and steel,

petroleum refining, ammonia and chemicals, pulp and paper, building materials, metal fabrication, water utilities, dairy processors, commercial services and commercial buildings.

Engineering & construction

Several engineering and construction companies have experience with biomass and biogas projects, however very few have knowledge and experience with industrial heat pumps, solar thermal or PV-thermal. Larger engineering companies’ in-house process engineering capability will allow them to perform necessary heat recovery optimisation and integration required but will need to gain experience in performing studies to optimise heating systems.

Industrial refrigeration contractors

Major industrial refrigeration contractors have the knowledge and skill set, which transfer to industrial heat pump projects and most are already working on quotations for such projects. However, the typical skill set for these companies may have limited process knowledge to allow the full optimisation of heat recovery / process integration opportunities.

On-site operations and maintenance

The low adoption levels of non-fossil fuel heating alternatives at operating sites gives low knowledge and skills across several factors. Knowledge of traditional steam boiler systems does transfer to bioenergy boiler systems and solar thermal whilst industrial refrigeration system knowledge does transfer to heat pumps systems.

5.4.4 Gap analysis in skills across each market participant

Table 39 presents a summary of the major and minor knowledge gaps needing immediate attention.

Table 39 Major and minor knowledge gaps impeding the uptake of non-fossil fuel process heating alternatives.

Skill	Advisory	Engineering & construction	Industrial refrigeration contractors	End user operations & maintenance	Supply chain
Technology awareness	Major improvement needed	Minor improvement needed	No gap	Minor improvement needed	No gap
Technology performance characteristics	Major improvement needed	Minor improvement needed	No gap	Minor improvement needed	No gap
Identifying and optimising heat recovery and heat source options	Major improvement needed	Minor improvement needed	Minor improvement needed	Minor improvement needed	Minor improvement needed
Optimising heat pump selection and thermal batteries	Major improvement needed	Minor improvement needed	Minor improvement needed	Minor improvement needed	Minor improvement needed
Business case development	Major improvement needed	Minor improvement needed	Minor improvement needed	Minor improvement needed	Minor improvement needed
Design and integration	Major improvement needed	Minor improvement needed	Minor improvement needed	Minor improvement needed	Minor improvement needed
Installation and maintenance	Major improvement needed	Minor improvement needed	Minor improvement needed	Minor improvement needed	No gap

Major gaps are seen in the advisory sector and on-site operations and maintenance in three main areas: technology awareness, optimisation of heat recovery and business case development as well as an overall ‘systems and services’ thinking to enable the use of decentralised heating systems.



### *5.4.5 Public awareness for non-fossil fuel process heating alternatives*

Awareness of non-fossil fuel heating alternatives is largely limited to industries that have been traditionally burning biomass, e.g., sugar and pulp mills. For industrial heat pumps, awareness has been increasing in the last few years among the food and beverage manufacturing industry largely due to the A2EP feasibility program and subsequent knowledge-sharing webinars. However, without regular knowledge sharing and outreach activities, momentum to look at heat pumps is likely to decline given the inherent increased complexity in looking at such solutions. For other high-energy using industries, which use process temperatures >150C, such as non-ferrous minerals, pulp and paper, petroleum refining, oil and gas extraction, cement, bricks and glass, the awareness of industrial heat pumps is virtually non-existent.

Local representative offices of heat pump manufacturers, Mayekawa, JCI and GEA have increased sales promotion of heat pump solutions, however the market will benefit from advice from a range of sources, including academics, other independent researchers and the federal government.

Educational service providers must be encouraged and supported to develop enhanced programs, which may include employing staff with different knowledge and skills.

### *5.4.6 Tools*

As outlined above, various new skills are required to achieve the best financial and technical outcome when switching to a non-fossil fuel heating system. These skills need to be complemented with tools, which can aid in translating these skills in to consistent and reliable recommendations for equipment and process changes. As an example, the sizing of a heat pump for a brewery process may require; heat recovery optimisation then simulation of waste heat sources and flows as well as modelling for seasonal and intra-day peak heating loads, maximising on-site renewables usage, participation in demand response markets and thermal battery sizing. At present, readily available tools such as Aspen or TRNSYS are not able to help with such simulations. Two different advisors looking at the same process may come up with completely different solutions creating uncertainty and potentially mistrust in the non-fossil fuel solution. The development of industry-specific, freely available tools for selecting non-fossil fuel heating technologies choices will help democratise the selection knowledge and harmonise the offering to end-users.

### *5.4.7 Cultural barriers across industry sectors*

As noted in other studies, the low appetite for risk in Australia acts as a barrier to the adoption of non-fossil fuel heating solutions. Industry in Australia also has a tendency to extend the life of existing equipment instead of replacing or making incremental changes through replacing individual elements in a process. There is also a strong influence of incumbent suppliers/contractors with established product and service arrangements. Two inherent factors of end users operating in Australia create risk aversion: the lack of local research, development and manufacture of heating technologies and the vast distances between end users and technical support. These factors have resulted in decades of difficult experience with implementing new technologies which are typically supported from supplier's overseas technical centres resulting in a lack of trust and confidence by project, operations and maintenance managers. Equipment supply organisations with strong local presence and capability are often successful in countering this barrier, however obtaining local critical mass in personnel and capability requires a costly and long-term investment which requires confidence in long term market potential.

Previous bad experience with non-fossil fuel heating technology diminishes trust and has long lasting effects as a barrier to adoption. Of note is the dairy farm sector which saw the uptake of heat pumps

from 2010 to 2015 encouraged by Government grants. Most participating dairy farms installed domestic grade heat pumps which were not suitable for the low water quality in common use at dairy farms. The aquatic centre industry has also had negative experience with heat pumps due to 'icing' problems giving poor performance of air source heat pumps during winter months. Whilst solutions were available to ensure successful implementation of heat pumps for both dairy farms and aquatic centres industries, the lack of knowledge and skills for advisors, contractors, equipment suppliers and end users led to this poor historical experience and will act as a future barrier to adoption.

### *5.4.8 Accreditation*

Trust will be a major barrier in the transition to non-fossil fuel heating technologies as end users will be expected to invest larger amounts of capital to reduce energy consumption and emissions. Fostering trust can be facilitated with accreditation of suppliers and products and demonstration projects, as well as improved monitoring and performance contracts.

As mentioned previously, cultural barriers have developed in industries due to poor experience with non-fossil fuel heating technologies. The heating technology chosen was not incorrect, however the individual components or installation methodology did not suit the application or industry. Furthermore, advertised performance characteristics are typically not verified or audited. As the non-fossil fuel heating industry expands, it is likely that the market attractiveness will increase and bring in new suppliers to the market. History has shown that this may attract suppliers of lower quality and less ability to provide high quality support when compared to the established suppliers.

Currently there are no industry bodies which can provide accreditation for suppliers and installers. An accreditation system for the non-fossil fuel heating technologies may offer a pathway to higher standard of quality and performance entering the market.

### *5.4.9 Recommended pathways to address deficiencies in education and training, accreditation, regulation, and cultural barriers*

*Recommendation #1: Building skills for finding opportunities, knowing performance characteristics and building trust*

Knowledge sharing in the form of case studies, webinars, white papers etc. is needed on a regular basis across multiple sectors to keep non-fossil fuel alternatives in the front of mind for advisors, designers and end users. Such knowledge sharing should also deliver deeper understanding of the performance characteristics of these technologies as well. (A2EP currently runs a webinar series promoting knowledge sharing however development of content is limited by available resources). The reluctance of consultants to freely share knowledge that they see as giving them a 'point of difference' is a specific challenge: inclusion of specific knowledge sharing requirements in early project contracts can be very important in the development of an industry. Demonstration of technologies across various sectors will give the direct experience needed to grow knowledge on the best opportunities and knowing performance characteristics.

*Recommendation #2: Building skills for optimising the integration of the non-fossil fuel heating technologies*

All end-users should be encouraged to map their energy flows using Sankey diagrams or mass and energy balances and heat recovery options must be explored before looking at changing the heating system. Energy consultants and technology companies should be encouraged to undertake pinch analysis and relevant process training to ensure maximum utilisation of waste heat. Development of

simulation tools, specific to the need of non-fossil fuel heating technologies is also needed and can be done in collaboration with existing simulation software suppliers. These simulation tools should address process integration (e.g., pinch analysis), peak heating demand simulations as well as thermal battery sizing and operating simulation.

### *Recommendation #3: Government support for overcoming cultural risk barriers and trust building*

The foundations for uptake of unseen technologies are good local supply companies with the depth of knowledge that can demonstrate they have experience with local installations in each relevant industry sector. This requires markets large enough to support several suppliers as well as enforcement of standards to keep out suppliers of lower quality that tend to damage the reputation of the technology. Both of these issues can be alleviated with dedicated industry associations for non-fossil fuel technologies combined with government support of demonstration projects for several years until critical mass is achieved with local supply organisations.

### *Recommendation #4: Government support for continuous improvement in performance, quality, and service levels of non-fossil fuel heating technologies*

To facilitate the continuous improvement in the performance, quality and service levels delivered by the non-fossil fuel heating technologies an industry body should be established with a mandate to support the development of these technologies. The industry body could oversee; performance testing of smaller-scale equipment, measurement and verification for larger scale equipment, coordination of the development of tools to foster implementation and overcome barriers, deliver training and certifications programs, and promote knowledge sharing.

## *5.5 Insufficient data*

Accurate and sufficient data without a shadow of a doubt plays a critical role in helping to inform decision-makers, government, potential sectors, new technology manufacturers, and power grid operators to make appropriate decisions on decarbonisation of electrification of process heat. This barrier can generally be categorised into two aspects: (i) inadequate information on manufacturing & manufactured products and Lack of precedents, and (ii) tools and software.

### *Inadequate information on manufacturing & manufactured technologies and lack of precedents*

Identifying the trends of technologies and the impact of new technology is important to decide the technology used and other installation and optimisation mechanism. However, there is insufficient data regarding energy consumption, fuel and electricity cost, operating hours of sectors, energy management and previously installed renewables and/or electrified heating systems that may lead to cost-effective opportunities being missed. This lack of information and precedent data may lead customers to avoid new technologies and continue with the less-risk conventional process.

#### *❖ Recommendation to overcome barriers insufficient data*

Sharing information among different stakeholders, advisory and manufacturers on a regular basis and providing customer evidence-based information can help to overcome this barrier. More pilot projects and their data can help to build interest in customers to install and use new technologies and processes based on renewables and/or electrification to displace fossil fuel.

## *5.6 Case study: Barriers for heating electrification in the healthcare sector*

This section uses healthcare as a case study. Please note, some parts of this case study identified barriers or enablers may be applicable to other commercial building types. The following paragraphs

provide a background description of healthcare CO<sub>2</sub> emission, heating needs for hospitals and aged care facilities in Australia.

### Why look at heating needs in the healthcare sector?

Healthcare accounts for 4.4% of global net emissions and Australian healthcare CO<sub>2</sub> emission is tenth in the world [328]. However, on the healthcare CO<sub>2</sub> emission per capita basis, Australia is within the top range in the world [328], along with Canada, Switzerland and the US. In addition to this, the hospital sector – among other commercial buildings – is set to suffer significant increases in energy costs and CO<sub>2,eq</sub> emissions under a BaU scenario, although would greatly benefit from accelerated decarbonisation of their low temperature heating needs (see Figure 95 and Figure 96, respectively).

### Heating needs at hospitals

The majority of heating needs at Australian hospitals are from hot water, steam, or in-duct electrical heating coils as part of the air-conditioning systems. Natural gas is a common energy source for water heating and steam heating in Australian hospitals. Hot water can be generated with water boilers to heat up potable water, softened water, or to be used for space heating purposes. Steam can be generated with steam boilers for sterilisation purposes or air conditioning system humidity control.

### Heating needs at residential aged care facilities

Fossil-fuelled heating in residential aged care facilities (RAC) can be similar to dwellings with hot water needs. Natural gas is often used at RAC to meet the needs for hot water and cooking.

Heat pump technologies, solar thermal, and photovoltaics are discussed in the following sections. Also, direct electrical heating (electrical boilers) is discussed as there is an increased level of renewable energy in Australian national grid. No preference is given to a particular technology in the healthcare sector. The selection of technology to lower carbon emission for healthcare heating may vary from site to site.

The following section discusses heating electrification barriers in general for the healthcare sector, except for solar thermal technologies which will be discussed after the following section. Please note that some barriers can act as enablers as well depending on the situation, such as financial factors. Healthcare heating electrification enabling factors will be discussed at last.

### *5.6.1 Healthcare heating electrification barriers*

#### *5.6.1.1 General barrier for heating electrification in the healthcare sector*

##### Heating electrification: mystery or might for CO<sub>2</sub> emission reduction

Some people claim that gas heating technologies may result in lower CO<sub>2</sub> emissions than heating with electrical technologies. To clarify this, a simple calculation example has been provided in Table 40. To have the same 1 kW or 3.6 MJ heat output, nine cases of different technologies and assumptions are compared for water heating in a commercial setting (healthcare/commercial buildings).

The emission per kWh heat output comparison assumes having the same piping from a central energy plant to use points however the differences are in the heating part: gas boilers without hot water tank or electrical heating technologies with hot water tanks.

In Table 40, three heating technologies are evaluated: natural gas boilers, direct electric boilers, and air sourced heat pumps. They are feasible and common water heating technologies.

## Electrification & Renewables to Displace Fossil Fuel Process Heating

- With direct electric heating technology and grid electricity supply, Case 2 results in about 4 times higher emissions compared to Case 1. However, considering lifecycle greenhouse gas emission, solar photovoltaic systems can have quite low intensity (mean or median value around 0.05 kg CO<sub>2</sub>/kWh [329-331]). Also, solar PV's emission intensity has been dropping over the past 30-40 years [332].
- Assuming with solar PV systems onsite and/or a high level of green power purchase [333], Case 3 has 0.18 kg CO<sub>2</sub>/kWh electricity supply and has a similar level CO<sub>2</sub> emission compared to Case 1.
- If a site is considered with very high renewable in grid supply and onsite solar generation, Case 4 has 0.05 kg CO<sub>2</sub>/kWh and Case 4's CO<sub>2</sub> emission is about a fourth of Case 1's emission.
- With a COP = 3 heat pump and grid electricity supply, Case 5 has a slightly higher emissions than Case 1.
- When high renewable is in the electricity supply, Case 6 considers a heat pump with COP = 3 and 0.54 kg CO<sub>2</sub>/kWh electricity supply, which result in a similar level CO<sub>2</sub> emission compared to Case 1.
- Case 7 considers a COP3 heat pump and 0.05 kg CO<sub>2</sub>/kWh electricity. Case 7 has 9% of Case 1's emission.
- When COP is increased to 4 in Case 8, the CO<sub>2</sub> emission would be on par with Case 1.
- Case 9 considers COP8 heat pumps and current grid emission level, which has half of the emission of Case 1.

In short,

- direct electrical heating may be low hanging fruit in terms of heating electrification; however, to have a similar or lower emission level compared to gas heating, direct electrical heating need have onsite renewable generation and/or a high level of green power purchase.
- On the other side, given the existing emission intensity on the Australian grid, heat pump technologies with COP higher than 4, the emission level would be lower than natural gas heating technologies.

*Table 40. Calculation for technologies comparison*

Heat output	Case No.	Heating technologies	Assumptions	CO <sub>2</sub> emission
1kWh or 3.6MJ heat	1	Natural gas water boiler (92% efficiency condensing gas boiler [334])	1kWh = 3.6MJ NG has 39 MJ/m <sup>3</sup> 1GJ NG = 51.53 kg CO <sub>2</sub> , based on NCC Table 3a in [335] 1 m <sup>3</sup> NG= 39MJ = 2 kg CO <sub>2</sub>	$1 \times 3.6 / 39 / 92\% \times 2$ =0.20kg
	2	Direct electric heating (99% efficiency)	1kWh =0.711kg CO <sub>2</sub> emission, based on 2020 grid electricity carbon intensity [336] 3% energy loss in energy storage/buffer, e.g., hot water tank	$1 \times 0.711 / 99\% \times (1+3\%)$ =0.74kg
	3	Direct electric heating (99% efficiency)	1kWh =0.19kg CO <sub>2</sub> (high renewable in electricity supply) 3% energy loss in energy storage/buffer, e.g., hot water tank	$1 \times 0.19 / 99\% \times (1+3\%)$ =0.20kg

## Electrification & Renewables to Displace Fossil Fuel Process Heating

4	Direct electric heating (99% efficiency)	1kWh =0.05kg CO <sub>2</sub> (very high renewable in electricity supply) 3% energy loss in energy storage/buffer, e.g., hot water tank	$1 \times 0.05 / 99\% \times (1+3\%)$ =0.052kg
5	Heat pump water heater (COP=3)	1kWh =0.711kg CO <sub>2</sub> 3% energy loss in energy storage/buffer, e.g., hot water tank	$1 \times 0.711 / 3 \times (1+3\%)$ =0.24kg
6	Heat pump water heater (COP=3)	1kWh =0.58 kg CO <sub>2</sub> (more renewable in electricity supply) 3% energy loss in energy storage/buffer, e.g., hot water tank	$1 \times 0.58 / 3 \times (1+3\%)$ =0.20kg
7	Heat pump water heater (COP=3)	1kWh =0.05 kg CO <sub>2</sub> (very high renewable in electricity supply) 3% energy loss in energy storage/buffer, e.g., hot water tank	$1 \times 0.05 / 3 \times (1+3\%)$ =0.017kg
8	Heat pump water heater (COP=4)	1kWh =0.711kg CO <sub>2</sub> 3% energy loss in energy storage/buffer, e.g., hot water tank	$1 \times 0.711 / 4 \times (1+3\%)$ =0.18kg
9	Heat pump water heater (COP=8)	1kWh =0.711kg CO <sub>2</sub> 3% energy loss in energy storage/buffer, e.g., hot water tank	$1 \times 0.711 / 8 \times (1+3\%)$ =0.092kg

The emission amounts and COP levels of the cases in Table 40 are presented in Figure 122.

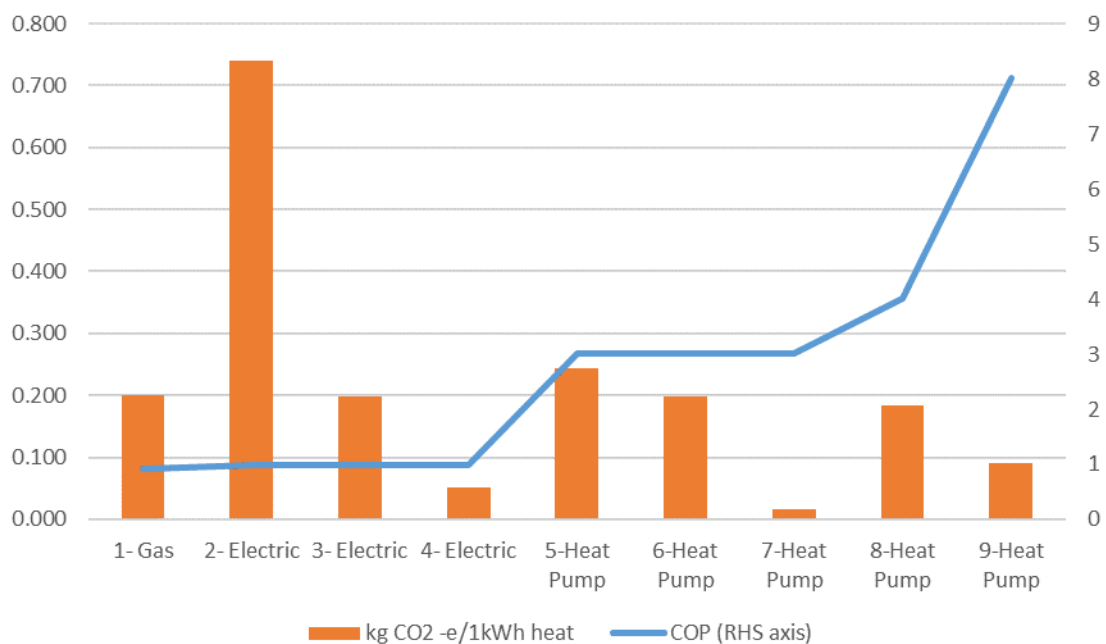

Figure 122. CO<sub>2</sub> emission by configuration cases

### Physical factors

Compared with fossil-fuelled boilers, electric boilers or heat pump technologies may not have the same level of power density like gas or diesel boilers. Therefore, to have the same level of hot water output or steam output, boilers with electrical technologies tend to be larger in size and require hot water tanks or steam accumulators as a buffer in case of high usage peaks.

Climate can be another barrier in heating electrification in the healthcare sector. For example, heat pumps may work more efficiently to produce hot water in warm climate zones compared to in temperate or cold climate zones.

Renewable energy sources are often variable. For example, solar radiance in one hour may be different from the next hour and solar radiation in one day may be different to the next day. Also, there are monthly variations, seasonal variations and yearly variations.

Solutions to manage the renewable resource variability can include designing a system with larger energy storage or combined with back up or fossil-fuelled booster boilers to cover peak heating demands. These solutions have space requirements and costs implications.

### Technical factors

Heating technology with a need for electricity (e.g., heat pump or direct electric boilers) can be difficult to be adopted for regions with frequent power outages or low power quality, since the reliability of the heating supply is important for healthcare providers.

Electricity use for heating may become the dominant component of the electricity bill when heating is electrified. This may pose an issue for retrofitting projects, where existing switchboard and wiring may limit the capacity of the electrified system.

Technical operation and maintenance knowledge needs to be acquired for site contractor's engineering design and construction staff as well as facility management staff if a heating energy source is retrofitted from a fossil fuel type to electricity powered or renewable-powered boilers, such as heat pumps or solar thermal.

### Financial factors

Energy price relative to heat output can be a barrier (or enabler). Depending on regions and the commercial arrangements, an electric boilers' operating costs can be higher or lower than a gas boilers' operating costs.

For retrofitting projects, the initial investment and return on investment are often important factors to consider. A small-scale retrofit of existing fossil fuel boilers may be more financially attractive compared to decommissioning fossil fuel boilers and installing completely new low carbon emission heaters.

For retrofitting projects on comparatively new healthcare buildings, it can be difficult to justify an electrification budget if the fossil fuel boilers' economic life is not exhausted or asset depreciation is not completed yet.

### Contingency strategies

This aspect can be a barrier to full heating electrification; however, it can also serve as a potential enabler for heating electrification. Heat supply and its energy source are often required to have redundancy at healthcare facilities. This aspect is related to reliability, resilience and contingency planning and the ability to take the plant offline for maintenance while maintaining heating to the operational facility.

When designing an energy plant for a hospital, contingency scenarios need to be considered. For example, what if all boilers run on gas and the gas pipeline is out of service due to a maintenance activity or an unexpected incident - conversely, what if all boilers are electric boilers and there is a network blackout.

Mixed types of boilers may be able to meet heating needs considering one energy source out of service, such as having a mix of electric boilers and gas boilers onsite.

### Lack of pilot projects and funding limitations

A hurdle of getting low carbon technologies more into healthcare (or broadly speaking for other industries) is the lack of pilot projects. Because the pilot project would provide

- real hands-on experience for our Australian local manufacturers
- case studies and marketing material for implementing more low carbon heating technologies
- confidence for other healthcare providers to consider low carbon heating technologies

Industry-led research projects can be a way to break the barrier and encourage this type of pilot project. However, depending on funding rules, hardware or capital investment may not be possible for some research funds.

Another aspect of the challenge in the pilot project is the measurement and verification for the technical and environmental performance of low carbon heating technology. For example, COPs of heat pump technologies vary depending on operational conditions and ambient situations. There are also research gaps in how to verify COP for in-situ heat pump technologies.

### 5.6.1.2 *Barriers for integrating solar thermal in healthcare*

In healthcare applications, solar thermal energy can provide heat to meet hot water needs or preheat water before feeding into boilers.

### Technical factors

Similar to other electrical heating or low carbon heating technologies, space can be a limiting factor for adopting solar thermal technologies. For solar energy collection, solar thermal technologies often require surface space, such as land space or roof space. However, most Australian hospitals or aged care communities are in urban or other built-up areas rather than in rural or very remote areas that have large areas available.

Climate can also be a factor for adopting solar thermal technologies. In regions of comparatively low solar radiation (compared to areas of year-round high solar radiation), to meet healthcare heating needs, larger thermal storage and possibly larger solar collection equipment installations would be needed. There are space needs and return on investment considerations when those larger installations are required.

### Finance and resources factors, e.g., initial costs, maintenance needs

Australia has about 1352 hospitals [100, 337] and 2695 residential aged care communities [105]. The number of both public and private hospitals does not change significantly over the years (5-year change ranges from -1.9% to 2.3% [100]).

Electrifying heating in new healthcare buildings seems to make sense. However, the above statistics indicate that there is much more potential in retrofitting existing healthcare buildings.

For existing operating healthcare buildings, budgets need to be allowed for feasibility, cost and benefit analysis in heating electrification, as well as transition planning. In addition, resources need to be allocated for training or subcontracting, or recruiting new staff to meet ongoing operation and maintenance needs for solar thermal heating or other low carbon heating technologies since existing facility engineers may not be familiar with solar thermal heating.



### Competing factors

Rooftop solar photovoltaic inverter systems (PV) can be a competing factor towards solar thermal heating technologies. PV technology is quiet, stable, having no mechanical components, requiring a minimum amount of maintenance and has been accepted widely in Australia. Rooftop PV collectively is the largest electricity generation source in Australia [338].

### Policy and international treaty for risks

Government policies and the definition of net-zero energy can have an impact on the risks of adopting solar thermal technologies. As an example, allowing Green Purchase may encourage offsite renewable energy to be purchased and credited for healthcare providers. This Green Purchase agreement can be a low-risk option, agreement and transaction based without site work for heating electrification.

However, based on some European definitions, building net-zero energy needs to be achieved within a property's boundary. When the property boundary requirement is implemented, low carbon and high-efficiency technologies may be considered for all aspects of building design or retrofitting to achieve site net zero energy, including local renewable generation and heating electrification.

### *5.6.2 Healthcare heating electrification enablers*

#### Governance and economic factors

For example, public hospitals could switch to a whole of government electricity pricing mechanism that would provide an incentive to move away from gas and onto electricity, and potentially renewables during the low-price points in the market and when the energy costs of electricity are lower than the cost of gas.

Private hospitals could do the same by consolidating their facilities energy usage with an energy retailer, but because private hospitals are nationally spread there should be a greater opportunity to play the energy market across the whole market and not just in a single state.

Queensland public hospitals have a whole-of-government 10-year flat electricity energy price (no peak or off-peak) that has resulted in gas generators or some tri-generation units becoming uneconomical at the current available gas prices in the market (since 2019). This will have a renewable energy component consistent with the government's renewable energy target which should lower emissions as well as be a more economical energy position.

Having this arrangement in place should inform the new build designs of energy plants for future hospitals so that the mix of energy sources for steam and hot water are balanced across either a gas price or competitive electricity price that is made up of both gas and renewables. Prices during the day are getting towards zero or negative which makes electricity very competitive, and if the installed plant is properly matched it could be possible to fuel switch to lower emissions and costs. It will require some decent planning for the development of the energy plant.

Besides adopting high renewables in heating electricity supply, to further decarbonise the emission from healthcare heating, low carbon technologies can be considered, such as heat pumps or solar thermal technologies.

#### Motivational/reputational/environmental sustainability

A motivational enabler can be a factor from a healthcare providers' employees and management.

A global initiative is to create “Health Care Without Harm” [339]. One project of Health Care Without Harm is Global Green and Healthy Hospitals (GGHH) [340]. GGHH aims to address ten interconnected goals (such as energy, water, waste, buildings, leadership etc.) to achieve greater sustainability and environmental health. By March 2021, there are over 43,000 hospitals and health centres from 72 countries, of which 31 Australian hospitals have joined the GGHH project.

In Australia, NABERS (National Australia Built Environment Rating System) provides a standard approach to assess the energy and water ratings of public hospitals [333]. However, as of March 2021, there is no public hospital data accessible from the NABERS portal.

Future work may include:

1. Heating demand studies for healthcare facilities.
2. Lifecycle cost and benefit analysis for low carbon heating technologies for healthcare.

These two recommendations may be adopted for future project proposals, as part of feasibility studies or development proposals.

### 5.7 Discussion and Recommendations

#### 5.7.1 Barriers and challenges

The wide range of applications, and specific temperature for different industrial processes pose challenges to implement renewables and electrification in process heat to replace fossil fuel. The potential barriers and proposals include technology, costs, impacts on grids, regulations, standards and policies, knowledge, skills, training and culture, and insufficient data and precedents.

A list of key barriers related to the above-mentioned categories are as follows:

- A common and significant practical challenge is the effective design of new technologies into plant configurations and control methodologies, considering appropriate local renewable resources. Furthermore, the selection of appropriate technology for specific temperature and industrial process depends on many factors such as TRL, location, and costs.
- Despite the relatively economic attractiveness of high-TRL technologies such as heat pump technology, access to finance or funds is seen as a barrier, considering its relatively higher CAPEX compared to gas boilers.
- Low appetite for risk, generally lower policy incentives for other technologies, Australia’s climate and high electricity prices as a ratio of natural gas and coal fuel, giving rise to high financial barriers.
- The potential electrification demand for process heat can pose challenges regarding electricity utility connections and reliability issues such as voltage stability, transmission congestion, frequency stability, reliability, flexibility and associated costs and upgrades in the power grid.
- A connection to the grid by a large electricity consumer (i.e., industrial), or an upgrade to a relatively much larger load, usually requires a non-standard process in Australia (i.e., “Negotiated services”) that is currently deemed complicated, costly, and time-consuming.
- Lack of Australian standards, particularly regarding high-temperature industrial pumps, MVRs, etc., as well as of updated Australian energy efficiency standards for process heat, could be seen as a barrier.
- Lower TRL technologies have low levels of awareness, knowledge, confidence, and skills as expected by their low levels of implementation in Australia.
- The well-established supply chains for fossil fuels and the low cost of systems for turning fossil fuels into useful heat provide a low-risk, well-proven, easy path for process heating.

- There is insufficient data regarding energy consumption, fuel and electricity cost, operating hours of sectors, energy management and previously installed renewables and/or electrified heating systems that may lead to the cost-effective opportunity being missed.

### 5.7.2 Opportunities and recommendations to overcome barriers

While there are significant opportunities and benefits of decarbonising process heat using renewables and/or electrification technologies including reduced energy demand and emissions, barriers still hinder implementing these net-zero carbon emission technologies. According to the above discussion on different barrier categories, several actions and policies can aid in reducing these barriers and increasing deployment. A list of recommendations is as follows:

#### Technology

Additional information regarding present technology capabilities, technology research development, and demonstration (RD&D) across wide range of applications can help industries to determine the best renewable and electrification technology for industries from short-to-long term solutions [341].

A gap in support often appears when a project nears commercialization, but still requires technology validation and demonstration [342]. Continuous support for demonstration projects for technologies that are moving towards market readiness is required to overcome this barrier.

#### Cost

Unlike traditional stand-alone and centralised process heating solutions, successful implementation of a non-fossil fuel alternative needs to take a more holistic approach to optimise capital and operating costs and therefore reduce the gap in the financial barriers.

Government can provide incentives, grants and rebates to overcome upfront cost barriers and thus promote the adoption of net-zero carbon emission processes. Accordingly, funding for detailed feasibility studies needs to be provided [263]. Furthermore, there is a need to identify specific financing mechanisms which may help to overcome relatively high CAPEX of renewable process heat infrastructure. In addition, incentives from utilities companies to the industrial and commercial customers for installing or using electrified heat could promote fossil fuel displacement from process heat and benefit utilities at the same time.

Policies that support financing renewables and the electrification-based process can help to overcome barriers. The initial installation cost barrier can be overcome through acceptable financing facilities and the risk to lenders could be reduced through the capital expenditure guarantee provided by the government.

#### Impacts on grids

Demand response can be used to enhance power system voltage stability and frequency stability [284, 285]. Combined with decentralised installations of renewable energy sources and other distributed generation, smart demand-side management of large-scale power-dependent consumers can postpone the expansion of the generation, transmission, and distribution systems.

Innovative smart storage heating solutions can be applied to both small electrified heat consumers (e.g. residential heat pumps) and large-scale industrial consumers to take advantage of variations in electricity prices throughout the day [343].

#### Regulations, standards, and policies

A streamlined process is required to overcome the barriers related to the high processing time for new and upgraded connections by large customers (e.g., industrial). Additionally, providing metering services for sub-loads shall be possible at relatively a small incremental cost (i.e. not that of an equivalent second connection), particularly that the additional cost for this would just be related to data-processing [306].

A review of tariff-restructuring, including peak demand charges, particularly for industries, so as to adapt to the potential opportunities in the electrification of process heat is also required to increase participation. Options such as demand response (i.e. through load flexibility) and active distributed energy management are need to be considered with effective pricing mechanisms [287, 293, 294].

Development of Australian standards for new technologies (i.e. high temperature heat pumps, etc.) [324], and best practices, revising and mandating energy efficiency standards in industries, development and application of regulatory measures for onsite renewable thermal energy generation and thermal storage [325], and considering the adoption of electrification of heat in buildings by ABCB as part of NZEB trajectory [323] will provide technical support to adopters and reduce barrier.

### Knowledge, skills, training, and culture

Knowledge sharing in the form of case studies, webinars, white papers etc. is needed on a regular basis across multiple sectors to help promote renewable heating solutions. A2EP currently runs a webinar series promoting knowledge sharing however development of content is limited by available resources.

Lack of local experience of new/unseen technologies installation and lower quality supply chain issues can be alleviated with dedicated industry associations for non-fossil fuel technologies combined with government support of demonstration projects for several years until critical mass is achieved with local supply organisations.

Energy consultants and technology companies should be encouraged to undertake necessary trainings to ensure maximum utilisation of waste heat.

### Insufficient tools and data

Development of simulation tools, specific to the need of non-fossil fuel heating technologies is also needed and can be done in collaboration with existing simulation software suppliers. These simulation tools should address process integration (e.g., pinch analysis), peak heating demand simulations as well as thermal battery sizing and operating simulation.

More research and pilot project outcomes and their data can help to build interest and confidence in customers to install and use new technologies and processes based on renewables and/or electrification to displace fossil fuel.

The solutions and opportunities with the renewables and electrification of process heat to overcome barriers are mapped in Figure 123.

## Electrification & Renewables to Displace Fossil Fuel Process Heating

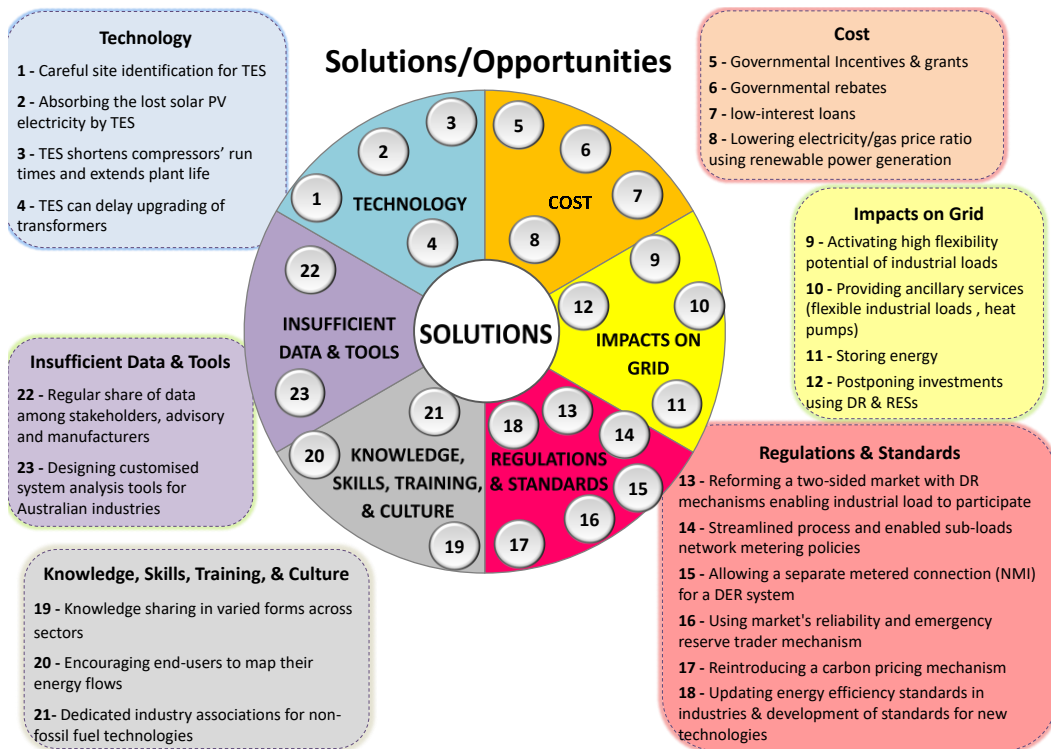

Figure 123. Solutions mapping for the electrification & renewables integration of process heat.

## 6 Industrial process heat decarbonisation: Path to impact

The combined impact of all the research opportunities presented in this report and roadmap will be to reduce the equivalent CO<sub>2</sub> emissions from industrial process heat below 150 °C by 50%. As of 2019, 334PJ of this heat was supplied by fossil fuels and cost industry approximately 6.2Bn AUD. Specific impacts and overall KPIs for each research opportunity are included where appropriate. Quantitative metrics for monitoring progress towards these impacts are discussed and summarised in Section 6.1.

Index	Research opportunity	Outputs	Outcomes	Impact and KPIs	
Short-term actions: Complete by 2023	S1	Potential for a combination of smart gas metering and targeted process heat energy flow analysis to provide more granular data on industry fossil fuel use for process heating and to make potential energy savings visible to end users.	<b>Data</b> - Detailed natural gas/LPG usage data across key industries/processes <b>New knowledge/information</b> - Preliminary report on gas usage analysis including comparison with estimations provided in this opportunity assessment. <b>New knowledge/information</b> - Theoretical Energy flow analysis reports for key industries/processes	<b>Reliability: Data</b> - Improved availability, reliability, and accuracy of fossil fuel consumption data within industry. <b>Affordability</b> - Increased affordability of energy by highlight opportunities for energy/cost savings. <b>Prosperity</b> - Generation of jobs: Installation and monitoring/analysis of data.	Improved accuracy and visibility of fuel consumption data that will help lead to the displacement of ~210PJ gas consumption for industrial heat <150 °C, currently costing industry \$2.3Bn per year.
	S2	Providing process modelling tools for accurate design and assessment of methods for economically reducing fossil fuel consumption in process heating.	<b>New knowledge/information</b> - Preliminary report on current process simulation software packages and what gaps exist with regards to renewable heat sources. <b>New software/tools</b> - Key renewable heat source algorithms identified in preliminary report. <b>New knowledge/information</b> - Report on validation of heat source algorithms.	<b>Affordability</b> - Reduced economic risk associated with renewable technology integration. <b>Prosperity</b> - Upskilling workforce and generation of jobs: Ongoing development of renewable heat source algorithms for process simulation software. <b>Drive innovation</b> - Development of tools to help drive innovation.	Increased uptake of renewable process heat technologies up to: • For industries with a low (2%) 2021 uptake, approximately 3.5% by 2025. • For industries with a high (10%) 2021 uptake, approximately 19% by 2025.
	S3	Effect of clear and consistent policy regarding emissions targets on the adoption of decarbonising technologies.	<b>Policy</b> - Updated and nationally consistent policy with strong emissions reduction targets covering all sources of emissions (energy generation, process heat etc).	<b>Reliability: Economic</b> - Stability and reliability of current and future economics associated with carbon emissions.	
	S4	Overcoming past negative experiences with, or misconceptions about different renewable process heat technologies	<b>New knowledge/information</b> - primary output format dependent on the answer to research questions. <b>Standards/guidelines</b> - Standards (updated and/or new) covering renewable process heat technologies	<b>Reliability: Technology</b> - Improved confidence in the reliability of renewable process heat technologies and improved reliability in the quality of renewable heat source installations (due to standards/guidelines).	
	S5a	Quantifying the impact of investment in process heat decarbonisation for different industry sectors.	<b>New knowledge/information</b> - Emissions abatement curve for process heat- <b>New knowledge/information</b> - Summary of high leverage industries/processes with recommendations for immediate actions to take. <b>New knowledge/information</b> - Summary of industries requiring support and recommendations for how to achieve this	<b>Affordability &amp; Reliability: Economic</b> - Increased affordability of decarbonisation via identification of the sectors/processes with the greatest decarbonisation for the least cost.	Effective distribution of investments to achieve 50% reduction in emissions by 2035.
	S5b	Potential measures that can drive effective and tangible decarbonisation within Australian Industry by increasing industry engagement	<b>New knowledge/information</b> - Report and analysis on methods to drive industry engagement in decarbonisation efforts. <b>Policy</b> - Rating scheme for process heat emissions.	<b>Prosperity</b> - Improved engagement in decarbonisation efforts by both individuals and industry leading to increased investment and jobs in this space.	
	S5c	Development of a database of desktop case studies (e.g., drawing on output of master's research programs) applicable to different technologies.	<b>New software/tools</b> - Public/industry accessible database of existing knowledge on renewable technology performance.	<b>Reliability: Economic</b> - Improved reliability of economic projections due to improved access to performance data for current and emerging renewable technologies.	Increased uptake of renewable process heat technologies up to: • For industries with a low (2%) 2021 uptake, approximately 3.5% by 2025. • For industries with a high (10%) 2021 uptake, approximately 19% by 2025.
	S5d	Improving understanding around the additional commercial and environmental benefits of renewable heat technologies.	<b>New knowledge/information</b> - Business case analysis for renewable technologies, including secondary benefits of adoption.	<b>Affordability &amp; Reliability: Economic</b> - Improved reliability of economic projections due to improved understanding of tangential benefits of renewable process heat technologies.	
	S6	Innovative funding models to support low-zero carbon process heat retrofitting	<b>New knowledge/information</b> - Report on innovative funding models to support renewable process heat technologies.	<b>Affordability</b> - Breakdown of economic barriers to the adoption of renewable process heat technologies.	
	S7	Targeted modelling and analysis of the different renewable process heat technologies identified in this opportunity assessment applied to the respective industrial processes.	<b>New knowledge/information</b> - Report on theoretical performance data for current/existing renewable process heat solutions applied to key industrial processes. <b>New technology/systems</b> - Report on theoretical performance of possible novel technologies/systems addressing specific process heat requirements of key industries.	<b>Reliability: Economic</b> - Increased reliability of economic decisions as a result of mapping cost competitive technologies/systems for renewable process heat to key industrial processes.	Effective use of investment dollars to achieve 50% reduction in emissions by 2035.
S8	Addressing the limitations for high/mid TRL heat pump and mechanical vapour recompression technologies	<b>New technology/systems</b> - Specialised heat-pump and mechanical vapour recompression based heat recovery systems targeting different types of industrial processes e.g., humid air heat recovery module.	<b>Clean energy</b> - Bridge technological gaps in current clean heat supply technologies. <b>Affordability &amp; Reliability: Technology</b> - Development of reliable, affordable heat recovery systems. Reduced costs through waste heat recovery. <b>Prosperity</b> - Generation of businesses/jobs in heat recovery solutions.	Up to 30% reduced total energy demand for the same heating load for processes adopting heat pump-based solutions.	

## Electrification & Renewables to Displace Fossil Fuel Process Heating

Index	Research opportunity	Outputs	Outcomes	Impact and KPIs	
Medium-term actions: Complete by 2025	M1	Capacity for skills and knowledge sharing/symbiosis between industries to support the transition to zero carbon process heat, including the promotion of an integrative design approach.	<b>New knowledge/information</b> - Report/plan on existing and skills/knowledge and the skills knowledge that will be required to develop and support a zero-carbon industry. <b>New organisation/body</b> - Establishment of a guiding body to support skills transition/development.	<b>Reliability: Process</b> - Improved reliability around operation and maintenance of renewable process heat technologies through fostering local skills development/sharing. <b>Prosperity</b> - Upskill workforce and generation of jobs to support transition to, and maintenance of, a net-zero emissions industry.	Increased resilience of industry to adapt to the changing energy landscape
	M2	Targeted pilot demonstrations, building on the work in this opportunity assessment and subsequent in-depth modelling and analysis, to kickstart market adoption of renewable process heat technologies.	<b>New knowledge/information</b> - Case studies and performance data for current/existing renewable process heat solutions applied to key industrial processes. <b>New technology/systems</b> - Novel technologies and systems addressing specific process heat requirements of key industries.	<b>Reliability: Technology</b> - Demonstration of the reliability of renewable process heat technologies and their ability to meet industry demand. <b>Affordability</b> - Demonstration of the costs associated with renewable heat supply technologies compared to fossil fuels."	Increased uptake of renewable process heat technologies up to: <ul style="list-style-type: none"> <li>For industries with a low (2%) 2021 uptake, approximately 13% by 2030.</li> <li>For industries with a high (10%) 2021 adoption, approximately 37% by 2030.</li> </ul>
	M3	Development of local supply chains for renewable process heat technologies e.g., industrial high temperature heat pumps	<b>New knowledge/information</b> - Report on the requirements/barriers for development of supply chains to support transition to net-zero carbon process heat. <b>New business/industry</b> - Support system for new businesses/industries addressing current supply chain shortcomings.	<b>Reliability: Supply</b> - Increase in the reliability of the supply of technology and support for renewable process heat solutions. <b>Prosperity</b> - Generation of jobs in the supply and ongoing support of renewable process heat technologies.	Approximately 5% of existing heat pump/refrigeration suppliers including high temperature heat pumps in their range.
	M4	Development of technologies to exploit waste streams from different industries for the generation of renewable fuel. e.g., production of biogas from anaerobic wastewater treatment in the Australian paper industry	<b>New knowledge/information</b> - Collection and analysis of performance data for current/emerging energy from waste systems (including water treatment, biomass etc.).	<b>Reliability: Energy supply</b> - Improved availability and supply of biofuels/biomass for process heat. <b>Affordability</b> - Generation of revenue from waste streams i.e., Circular economy.	Increased utilisation of bioenergy for process heating. <ul style="list-style-type: none"> <li>Indicative impact: The Maryvale EFW plant is expected to reduce natural gas consumption by 4PJ per year in the pulp and paper industry.</li> </ul>
	M5	Demand response mechanisms and industry-based energy storage as a means of addressing issues associated with widespread electrification of industrial process heat	<b>New knowledge/information</b> - Detailed report/analysis on the impact of electrification of process heat. <b>New technology/systems</b> - Smart technology to manage distributed demand response mechanisms. <b>Policy/guidelines</b> - Guidelines to design/update grid connection policy"	<b>Reliability: Energy supply</b> - Improved reliability of a decarbonised electricity grid.	Increased utilisation of daytime solar, approximately 1270 GWh/year. Improved demand flexibility that will result in additional savings. Increased maximum and minimum load demand by approximately 12% and 15% respectively.
	M6	Accelerating low TRL process heat technologies and breakthrough opportunities in existing technologies	<b>New technology/systems</b> – Advancement of new technologies, with a focus on developments towards commercial products for industrial heating.	<b>Clean energy</b> - Bridge technological gaps in current clean heat supply technologies. <b>Affordability &amp; Reliability: Technology</b> - Development of reliable, affordable heating systems. <b>Prosperity</b> - Generation of businesses/jobs in heat recovery solutions.	Increased uptake of renewable process heat technologies up to: <ul style="list-style-type: none"> <li>For industries with a low (2%) 2021 uptake, approximately 3.5% by 2025.</li> <li>For industries with a high (10%) 2021 uptake, approximately 19% by 2025.</li> </ul>

Long-term actions: Complete by 2030	L1	Continuous monitoring of fossil fuel usage data and project performance	<b>New knowledge/information</b> - Ongoing analysis and reporting of fossil fuel usage data. <b>New software/tools</b> - Public/industry accessible database of fossil fuel consumption.	<b>Reliability: Data</b> - Ongoing access to reliable fossil fuel usage data.	Tracking of progress towards accelerated reduction in emissions.
	L2	Funding structures/mechanisms to support industry lead development of decarbonising technology for Australia's largest consumers of process heat.	<b>New technology/systems</b> - Specialised large scale MVR systems for heat recovery in heavy industrial processes e.g., alumina refining. <b>New knowledge/information</b> - Report on funding solutions to support heavy industry decarbonisation"	<b>Affordability</b> - Reduced cost of development for large scale renewable heat supply technologies for heavy industry.	MVR energy cost approximately 50% that of natural gas boilers.

### 6.1 Quantitative key performance indicators

The most appropriate quantitative KPIs required to track the progress of displacing 50% of CO<sub>2,eq</sub> emissions by 2035 are: the total market penetration of renewable technologies (as a percentage of low temperature heat generated in Australian industry); which directly drive reductions in CO<sub>2,eq</sub> emissions themselves; and subsequently the annual savings to the Australian private sector in operational fuel costs. The required changes in these metrics compared to a 2019 baseline are summarised in Table 41 and progress will require a combination of self-reporting via RACE project teams or industry bodies (or a similar equivalent) through improved gas and electricity usage monitoring (opportunities S1 and L1 are specifically intended to aid in this process) and summary statistics from future versions of the Australian Energy Statistics and the National Pollutant Inventory.

The indicators in Table 41 are presented on an annual basis, assuming gradual market penetration of fossil-fuel-free technologies. However, uptake of renewable technologies is more likely to occur in a discrete, step-wise manner as different industries retrofit facilities. Emissions reductions and fuel cost reductions will lag behind these changes. Values at 2025 and 2030 are therefore highlighted as these may better account for this progressive market penetration. It is also important to note that the RACE for 2030 program will finish prior to the 2035 target.

Table 41. Quantitative key performance indicators required to meet 2035 accelerated scenario targets. Metrics in 2025 and 2030 correspond to milestones for impact.

Compared to 2019 Baseline	Year (2022 – 2035)													
	2022	2023	2024	<b>2025</b>	2026	2027	2028	2029	<b>2030</b>	2031	2032	2033	2034	<b>2035</b>
Market penetration of renewable technologies (%)	14	16	17	<b>19</b>	22	26	30	33	<b>37</b>	40	42	45	48	<b>50</b>
Reduction in CO <sub>2,eq</sub> (kt emissions p.a.)	64	146	250	<b>378</b>	537	733	972	1258	<b>1596</b>	1990	3228	3948	4726	<b>5532</b>
Reduction in fuel costs (\$k AUD p.a.)	6.3	14	24	<b>36</b>	52	71	94	123	<b>157</b>	199	352	436	528	<b>625</b>



## 7 References

- [1] AES. Australian Energy Statistics, Department of Industry, Science, Energy and Resources, [www.energy.gov.au](http://www.energy.gov.au). 2020.
- [2] Lovegrove K, Alexander D, Bader R, Edwards S, Lord M, Mojiri A, et al. Renewable energy options for industrial process heat, <https://arena.gov.au/>. 2019.
- [3] Thiel GP, Stark AK. To decarbonize industry, we must decarbonize heat. *Joule*. 2021;5:531-50.
- [4] Agency IE. Net Zero by 2050: A Roadmap for the Global Energy Sector. May 2021.
- [5] Hasanbeigi A, Kirshbaum, LA, Collison, B and Gardiner, D. Electrifying U.S. Industry: A Technology- and Process-Based Approach to Decarbonization. Renewable Thermal Collaborative 2021.
- [6] NPI. National Pollutant Inventory data, Retrieved from <http://www.npi.gov.au>. 2020.
- [7] IE. Pulp & Paper Industry Overview & Outlook Seventeen22, IndustryEdge, [www.industryedge.com.au](http://www.industryedge.com.au). 2017.
- [8] Afkhami B, Akbarian B, Beheshti A N, Kakaee AH, Shabani B. Energy consumption assessment in a cement production plant. *Sustainable Energy Technologies and Assessments*. 2015;10:84-9.
- [9] Senior A, Britt AF, Summerfield D, Hughes A, Hitchman A, Cross A, et al. Australia's Identified Mineral Resources 2019. Geoscience Australia, Canberra. . 2020.
- [10] Australian aluminium council website. <https://aluminium.org.au/aluminium/> 2021.
- [11] Haldar S. Chapter 13—Mineral processing. *Mineral exploration*. 2018:259-90.
- [12] Brough D, Jouhara H. The aluminium industry: A review on state-of-the-art technologies, environmental impacts and possibilities for waste heat recovery. *International Journal of Thermofluids*. 2020;1:100007.
- [13] Donoghue AM, Frisch N, Olney D. Bauxite mining and alumina refining: process description and occupational health risks. *Journal of occupational and environmental medicine*. 2014;56:S12.
- [14] Fish WM. Alumina calcination in the fluid-flash calciner. *Essential Readings in Light Metals*: Springer; 2016. p. 648-52.
- [15] Scarsella AA, Noack S, Gasafi E, Klett C, Koschnick A. Energy in alumina refining: Setting new limits. *Light Metals 2015*: Springer; 2015. p. 131-6.
- [16] Perander LM, Gasafi E, Scarsella A. Cost and energy efficiency improvement in alumina calcination. 2018.
- [17] Königsberger E. Thermodynamic simulation of the Bayer process. *International journal of materials research*. 2008;99:197-202.
- [18] Farrokh M. Thermodynamic process modeling and simulation of a diaspore bauxite digestion process: Mälardalen University Press Licentiate Thesis; 2013.
- [19] Balomenos E, Pantias D, Paspaliaris I. Energy and exergy analysis of the primary aluminum production processes: a review on current and future sustainability. *Mineral Processing & Extractive Metallurgy Review*. 2011;32:69-89.
- [20] G.J. Nathan, M. Suenaga, T. Kodama, D. Tourbier, H. Zughbi, B.B. Dally, et al. HiTeMP Outlook 2018. Transforming High Temperature Minerals Processing: A multi-stakeholder perspective on pathways to high value, net-zeroCO2 products for the new economy. University of Adelaide. 2019.
- [21] IEA (2020), International Energy Agency website, Aluminium Production, <https://www.iea.org/reports/aluminium>, Accessed on April 2021.
- [22] Chatfield R. Renewables and Electrification in Alumina Refining. 2020 Energy and Mines Conference. 2020.
- [23] Read S, Howell C. National 'state of the forests' reporting in Australia. Taylor & Francis; 2019.
- [24] Economics, Australian Bureau Of Agricultural Resource, Australian forest and wood products statistics. 2020.
- [25] Australian Bureau of Agricultural and Resource Economics, <https://www.agriculture.gov.au/abares>. 2016.
- [26] Redman AL. Modelling of vacuum drying of Australian hardwood species, PhD Thesis Queensland University of Technology; 2017.

- [27] Redman A. Evaluation of super-heated steam vacuum drying viability and development of a predictive drying model for four Australian hardwood species, Forest & Wood Products Australia, <https://www.fwpa.com.au>. 2011.
- [28] TQ. Moisture in Timber, Technical datasheet , Timber Queensland limited, <http://www.hyne.com.au>. 2014.
- [29] Anderson J-O, Toffolo A. Improving energy efficiency of sawmill industrial sites by integration with pellet and CHP plants. Applied energy. 2013;111:791-800.
- [30] Nolan G, Innes T, Redman A, McGavin R. Australian hardwood drying best practice manual. Part 2, Forest and Wood Products Australia. 2003.
- [31] Wallis NK. Australian timber handbook. Timber Development Associations of Australia Angus and Robertson; 1963.
- [32] Bergman R, Cai Z, Carll CG, Clausen CA, Dietenberger MA, Falk RH, et al. Wood handbook: wood as an engineering material. Forest Products Laboratory. 2010;10.
- [33] McKay Timber website: Process, <https://mckaytimber.com.au/process/>. Accessed Feb 17, 2021.
- [34] Anderson J-O, Westerlund L. Improved energy efficiency in sawmill drying system. Applied Energy. 2014;113:891-901.
- [35] Renström R. The potential of improvements in the energy systems of sawmills when coupled dryers are used for drying of wood fuels and wood products. Biomass and Bioenergy. 2006;30:452-60.
- [36] Elustondo D, Oliveira L. Opportunities to reduce energy consumption in softwood lumber drying. Drying Technology. 2006;24:653-62.
- [37] Gopalakrishnan B, Mardikar Y, Gupta D, Jalali SM, Chaudhari S. Establishing baseline electrical energy consumption in wood processing sawmills for lean energy initiatives: A model based on energy analysis and diagnostics. Energy engineering. 2012;109:40-80.
- [38] González AM, Jaén RL, Lora EES. Thermodynamic assessment of the integrated gasification-power plant operating in the sawmill industry: An energy and exergy analysis. Renewable Energy. 2020;147:1151-63.
- [39] Khouya A. Performance assessment of a heat pump and a concentrated photovoltaic thermal system during the wood drying process. Applied Thermal Engineering. 2020;180:115923.
- [40] Moya J, Pavel C. Energy efficiency and GHG emissions: Prospective scenarios for the pulp and paper industry, Publications Office of the European Union, Luxembourg. EUR; 2018.
- [41] Suhr M, Klein G, Kourti I, Gonzalo MR, Santonja GG, Roudier S, et al. Best available techniques (BAT) reference document for the production of pulp, paper and board. Eur Comm. 2015;906.
- [42] Francis DW, Towers M, Browne T. Energy cost reduction in the pulp and paper industry-an energy benchmarking perspective, Pulp and Paper Research Institute of Canada. 2002.
- [43] Bajpai P. Pulp and paper industry: energy conservation. 1st ed: Elsevier; 2016.
- [44] Bajpai P. Biermann's Handbook of Pulp and Paper: Volume 1: Raw Material and Pulp Making: Elsevier; 2018.
- [45] Laurijssen J. Energy use in the paper industry An assessment of improvement potentials at different levels. PhD thesis, Utrecht University. 2013.
- [46] Energy from Waste Feasibility Study Summary, Australian paper media release, <http://www.australianpaper.com.au/>. 2019.
- [47] Australian Paper and SUEZ partner on \$600M Energy from Waste project, <https://www.suez.com.au/en-au/news/press-releases/suez-and-australian-paper-partner-on-600m-energy-from-waste-project>. 2019.
- [48] Laurijssen J, Frans J, Worrell E, Faaij A. Optimizing the energy efficiency of conventional multi-cylinder dryers in the paper industry. Energy. 2010;35:3738-50.
- [49] De Beer J, Worrell E, Blok K. Long-term energy-efficiency improvements in the paper and board industry. Energy. 1998;23:21-42.
- [50] Jankes G, Tanasić N, Stamenić M, Adžić V. Waste heat potentials in the drying section of the paper machine in UMKA cardboard mill. Thermal Science. 2011;15:735-47.
- [51] Holik H. Handbook of paper and board: John Wiley & Sons; 2006.

- [52] Ruffo R, Malton S. Energy savings in stock preparation for recycled paper. *Appita: Technology, Innovation, Manufacturing, Environment*. 2008;61:277.
- [53] IEA. Annex of the report: World Energy Investment Outlook 2014. 2014.
- [54] Kong L, Hasanbeigi A, Price L. Emerging Energy-efficiency and Greenhouse Gas Mitigation Technologies for the Pulp and Paper Industry. Lawrence Berkeley National Lab.(LBNL), Berkeley, CA (United States); 2012.
- [55] State of the Industry, Australian Food and Grocery Council, [www.afgc.org.au](http://www.afgc.org.au). 2019.
- [56] Council ASM. Sugar Facts: Electricity Cogeneration. 2021.
- [57] Dairy Australia, Situation & Outlook Report December 2020, [www.dairyaustralia.com.au](http://www.dairyaustralia.com.au). 2020.
- [58] Atkins MJ, Walmsley MR, Neale JR. Integrating heat recovery from milk powder spray dryer exhausts in the dairy industry. *Applied Thermal Engineering*. 2011;31:2101-6.
- [59] Milk Powder Technology Evaporation and Spray Drying, GEA Process Engineering, 2010, <https://www.gea.com/en/index.jsp>. 2010.
- [60] Bylund G. Dairy processing handbook: Tetra Pak Processing Systems AB; 2003.
- [61] Walmsley TG, Atkins MJ, Walmsley MR, Philipp M, Peesel R-H. Process and utility systems integration and optimisation for ultra-low energy milk powder production. *Energy*. 2018;146:67-81.
- [62] Zhang Y, Munir MT, Udugama I, Yu W, Young BR. Modelling of a milk powder falling film evaporator for predicting process trends and comparison of energy consumption. *Journal of Food Engineering*. 2018;225:26-33.
- [63] Oldfield D, Taylor M, Singh H. Effect of preheating and other process parameters on whey protein reactions during skim milk powder manufacture. *International Dairy Journal*. 2005;15:501-11.
- [64] Relative Costs of Doing Business in Australia: Dairy Product Manufacturing, Productivity Commission Research Report, [www.pc.gov.au](http://www.pc.gov.au). 2014.
- [65] Eco-efficiency for the Dairy Processing Industry, 2019 edition, [www.dairyaustralia.com.au](http://www.dairyaustralia.com.au). 2019.
- [66] Ramirez C, Patel M, Blok K. From fluid milk to milk powder: Energy use and energy efficiency in the European dairy industry. *Energy*. 2006;31:1984-2004.
- [67] AMPC. Annual Report 2019–2020, Australian Meat Processor Corporation (AMPC), <https://www.ampc.com.au/uploads/AMPC-Annual-Report-2019-2020.pdf>. 2020.
- [68] McCabe BK, Harris P, Antille DL, Schmidt T, Lee S, Hill A, et al. Toward profitable and sustainable bioresource management in the Australian red meat processing industry: A critical review and illustrative case study. *Critical Reviews in Environmental Science and Technology*. 2020;50:2415-39.
- [69] Pagan R, Renouf M, Prasad P. Eco-efficiency manual for meat processing, Meat and Livestock Australia Ltd. 2002.
- [70] Graeme Pollock, Mason C. Options to Maximise Process Heat Recovery at Red Meat Processing Facilities, AMPC (Australian Meat Processor Corporation), <https://www.ampc.com.au/>. 2015.
- [71] Ridoutt B, Sanguansri P, Alexander D. Environmental performance review: Red meat processing sector 2015. Prepared for the Australian Meat Processor Corporation Australian Meat Processor Corporation. 2015.
- [72] Olivia Kember, Roger Horwood, Xu R. Emission reduction pathways and opportunities for the Australian red meat processing sector, Australian Meat Processor Corporation(AMPC), <https://www.ampc.com.au/>. 2019.
- [73] Colley TA. Heat Integration and Renewable Energy in Meat Processing Plants, Thesis for Masters of Engineering Science: Monash University; 2016.
- [74] Meat and Livestock Australia Limited, Environmental Best Practice Guidelines for the Red Meat Processing Industry, Locked Bag 991, North Sydney NSW 2059. 2007.
- [75] AMPC. 2020 Environmental Performance Review (EPR) for the Red Meat Processing (RMP) Industry. Australian Meat Processor Corporation (AMPC), Meat & Livestock Australia (MLA). 2021.
- [76] Tang P, Jones M. Energy Consumption Guide for Small to Medium Red Meat Processing Facilities. Australian Meat Processor Corporation: Sydney, Australia. 2013.
- [77] BZE. Zero carbon industry plan: electrifying industry, Beyond Zero Emissions, [www.bze.org.au](http://www.bze.org.au). 2018.

- [78] ACIL Allen Consulting (2019), Economic contribution of the Australian brewing industry 2017-18: from producer to consumer. Report prepared for brewers association of Australia and New Zealand INC., Canberra. 2019.
- [79] Elliott J. Australian Craft Beer Brewery List, <http://craftbeerreviewer.com/the-brewery-list/>, accessed 24 Feb 2021.
- [80] Brodie PJ. A framework for sustainable energy reduction in modern breweries, Masters by Research thesis: Queensland University of Technology; 2015.
- [81] Willaert R. The beer brewing process: Wort production and beer. Handbook of food products manufacturing. 2007;2:443.
- [82] Fadare D, Nkpubre D, Oni A, Falana A, Waheed M, Bamiro O. Energy and exergy analyses of malt drink production in Nigeria. Energy. 2010;35:5336-46.
- [83] Eßlinger HM, Narziß L. Beer. Ullmann's Encyclopedia of Industrial Chemistry. 2000.
- [84] Scheller L, Michel R, Funk U. Efficient use of energy in the brewhouse. MBAA TQ. 2008;45:263-7.
- [85] McCabe JT. The practical brewer: a manual for the brewing industry: Master Brewers Association of the Americas; 1999.
- [86] Aroh K. Beer Production. SSRN Electronic Journal, <https://dxdoiorg/102139/ssrn3458983>. 2018.
- [87] Muigai GC. Study Of Thermal Energy Use At A Brewing Plant With Emphasis On Wort Boiling Process: University of Nairobi; 2013.
- [88] Luljeta P, Ilirjan M, Lorina L, Jonilda L. Efficient use of energy an important approach in minimizing environment and operational costs in albanian breweries, <https://doi.org/10.31410/eraz.2018.715>. Fourth international scientific conference ERAZ 2018.
- [89] Muster-Slawitsch B, Weiss W, Schnitzer H, Brunner C. The green brewery concept—energy efficiency and the use of renewable energy sources in breweries. Applied Thermal Engineering. 2011;31:2123-34.
- [90] Schmitt B, Lauterbach C, Dittmar M, Vajen K. Guideline for the utilization of solar heat in breweries. Proceedings Eurosun Rijeka, Kroatien. 2012.
- [91] Association B. Energy usage, GHG reduction, efficiency and load management manual. Brewers Association A Passionate Voice for Craft Brewers. 2013.
- [92] Rivera A, González JS, Carrillo R, Martínez JM. Operational change as a profitable cleaner production tool for a brewery. Journal of Cleaner Production. 2009;17:137-42.
- [93] Lauterbach C, Schmitt B, Vajen K, Jordan U. Solar Process Heat in Breweries-Potential and Barriers of a New Application Area. Renew Energy. 2009:645-7.
- [94] Dri M, Antonopoulos I, Canfora P, Gaudillat P. Best Environmental management Practice for the Food and Beverage Manufacturing Sector. Publications Office of the European Union. 2018.
- [95] J K, S S, Boyd R, Ashby B, Steele K. Health Care's Climate Footprint How the Health Sector Contributes. 2019. p. 48.
- [96] Barbieri S, Jorm L. Travel times to hospitals in Australia. Scientific Data. 2019;6:2--7.
- [97] Australian Institute of Health and Welfare. Separations - Glossary 2020:1--11. <https://meteor.aihw.gov.au/content/index.phtml/itemId/327268>. 2020. p. 1--11.
- [98] Australian Institute of Health and Welfare. Number of patient days - Glossary:2016. <https://meteor.aihw.gov.au/content/index.phtml/itemId/269090>. 2016. p. 2016.
- [99] Australian Bureau of Statistics. Australia Private Hospitals 2018. <https://www.abs.gov.au/statistics/health/health-services/private-hospitals-australia/2016-17> (accessed February 6, 2021). 2018.
- [100] Australian Institute of Health and Welfare. Data table: Hospital resources 2017-2018 2020. <https://www.aihw.gov.au/reports/hospitals/hospital-resources-2017-18-ahs/contents/summary> (accessed February 6, 2021). 2020.
- [101] Australian Institute of Health and Welfare. Appendix C: Alphabetical listing of public and private hospitals n.d. [www.aihw.gov.au](http://www.aihw.gov.au) › 14825-appendix-c.xls.aspx%0A (accessed February 6, 2021).
- [102] Hasanuzzaman M, Islam MA, Rahim NA, Yanping Y. Energy demand, <https://doi.org/10.1016/B978-0-12-814645-3.00003-1>: Elsevier Inc.; 2019.

- [103] Department of Climate Change and Energy Efficiency. Factsheet Boiler Efficiency. vol. 21. <https://doi.org/10.1111/j.1559-3584.1909.tb04499.x>. 1909. p. 330--5.
- [104] Schultz B. A major hospital monthly energy water report (Jan 2019 to Dec 2019). Brisbane, Queensland, Australia. 2019.
- [105] Australian Institute of Health and Welfare. Aged care snapshots 2019. <https://www.aihw.gov.au/reports/australias-welfare/aged-care> (accessed February 7, 2021). 2019.
- [106] Mavromaras K, Knight G, Isherwood L, Crettenden A, Flavel J, Karmel T, et al. National Aged Care Workforce Census and Survey – The Aged Care Workforce, 2016. 2017. p. 229.
- [107] Australian Government Department of Health. 2019-2020 Report on the Operation of the Aged Care Act 1997. 2020.: Australian Department of Health; 2020.
- [108] Australian Institute of Health and Welfare. Older Australian at a glance. AIHM 2021;9:6. <https://www.aihw.gov.au/reports/older-people/older-australia-at-a-glance/contents/diverse-groups-of-older-australians/regional-remote-communities> (accessed February 9, 2021). 2021. p. 6.
- [109] N S W Office of Environment and Heritage, editor. Energy Saver Aged-care toolkit 2014:36. 2014. p. 36.
- [110] Vikstrom A, Boyle R, Harkness S, Hargraves J, McKinnon A. Summary of Energy Audits ( Level 2 ) – Aged Care Facilities. Sustainable Living Tasmania; 2015. p. 1--15.
- [111] AS/NZS 3500.4 Australian/New Zealand Standard Plumbing and drainage. Part 4: Heated water services. 2018.
- [112] The Australian Building Codes Board. National Construction Code Volume One 2013:616. 2013.
- [113] Standards Australia. AS/NZS 4234:2008 Heated Water Systems - Calculation of energy consumption 2008.
- [114] Australian Bureau of Statistics. 86350DO001\_201516 Tourist Accommodation, Australia, 2015-16 . <https://www.abs.gov.au/statistics/industry/tourism-and-transport/tourist-accommodation-australia/2015-16#data-download> (accessed February 9, 2021). 2016.
- [115] Australian Industry and Skills Committee - Hospitality. <https://nationalindustryinsights.aisc.net.au/industries/tourism-travel-and-hospitality/hospitality> (accessed February 9, 2021). 2020.
- [116] Johnston P. Industrial Sector is Waking Up to Energy Efficiency. Fifth State Web Page2020.
- [117] Logic C. TFI Australia's First Heat Pump. Cold Logic Wep Page2019.
- [118] Jutsen J, Pears, A., Mojiri, A., Hutton, L. Transforming Energy Productivity in Manufacturing. Australian Alliance for Energy Productivity; July 2018.
- [119] Productivity AAFÉ. Renewable Energy for Process Heat: Opportunity Study. Australian Renewable Energy Agency; May 2020.
- [120] Power I. Renewable Energy Options for Australian Industrial Gas Users. Australian Renewable Energy Agency; September 2015.
- [121] Agency ARE. Mechanical Vapour Recompression for Low Carbon Alumina Refining. Arena.gov.au2021.
- [122] Collaborative RT. Sustainable Options for Reducing Emissions from Thermal Energy: Showcasing Successful Outcomes from Six Case Studies. Center for CLimate and Energy Solutions: Renewable Thermal Collaborative; October 2018.
- [123] GEA. Sweet Solution from GEA reduces emissions at Mars. GEA Website2021.
- [124] Authority EEaC. MVR (Mechanical Vapour Recompression Systems for Evaporation, Distillation and Drying). 2019.
- [125] Edgar Zimmer HH, Michael Latz. Energetically Optimized Concentration of Fruit Juices. Bucher Unipektin AG; 2016.
- [126] GEA. London District Heating Project Using GEA Heat Pumps, Set to Become Global Benchmark. 2017.
- [127] Arpagaus C, Bless F, Uhlmann M, Schiffmann J, Bertsch SS. High temperature heat pumps: Market overview, state of the art, research status, refrigerants, and application potentials. Energy. 2018;152:985-1010.

- [128] Ministry of Business IE. Process Heat in New Zealand. 2019.
- [129] ITP Thermal Pty Limited. Renewable energy options for industrial process heat. 2019. p. 214.
- [130] AEMO. <https://aemo.com.au/>. 2021.
- [131] [www.aip.com.au](http://www.aip.com.au).
- [132] <https://energyexchange.energyaction.com.au>.
- [133] Elliston B, MacGill I, Diesendorf M. Least cost 100% renewable electricity scenarios in the Australian National Electricity Market. *Energy Policy*. 2013;59:270-82.
- [134] Bartholdsen H-K, Eidens A, Löffler K, Seehaus F, Wejda F, Burandt T, et al. Pathways for Germany's Low-Carbon Energy Transformation Towards 2050. *Energies*. 2019;12:2988.
- [135] Klaus T, Vollmer C, Werner K, Lehmann H, Müsche K. Energy target 2050: 100% renewable electricity supply. Federal Environment Agency Germany 2010.
- [136] Wulf C, Zapp P, Schreiber A. Review of Power-to-X Demonstration Projects in Europe. *Frontiers in Energy Research*. 2020;8.
- [137] [www.neste.com](http://www.neste.com).
- [138] <https://www.greena.com/en/market-analysis/>.
- [139] [www.renewablesa.sa.gov.au/topic/hydrogen/hydrogen-projects-south-australia](http://www.renewablesa.sa.gov.au/topic/hydrogen/hydrogen-projects-south-australia).
- [140] International Renewable Energy Agency. Green hydrogen cost reduction - Scaling up renewables to meet the 1.5 °C climate goal. 2020.
- [141] Gas Vision 2050 - delivering a clean energy future. . 2020.
- [142] Carlu E, Truong T, Kundevski M. Biogas opportunities for Australia. 2019.
- [143] Wu D, Hu B, Wang RZ. Vapor compression heat pumps with pure Low-GWP refrigerants. *Renewable and Sustainable Energy Reviews*. 2021;138:110571.
- [144] Mayekawa Australia. Ammonia Heat Pumps. Mayekawa Website 2021.
- [145] Bruno F, Belusko M, Halawa E. CO<sub>2</sub> Refrigeration and Heat Pump Systems—A Comprehensive Review. *Energies*. 2019;12:2959.
- [146] Zhang J-F, Qin Y, Wang C-C. Review on CO<sub>2</sub> heat pump water heater for residential use in Japan. *Renewable and Sustainable Energy Reviews*. 2015;50:1383-91.
- [147] <https://www.piller.de/products-applications/processes/mechanical-vapor-recompression-mvr/>.
- [148] Walmsley TG, Walmsley MRW, Neale JR, Atkins MJ. Pinch analysis of an industrial milk evaporator with vapour recompression technologies. *Chemical Engineering Transactions*. 2015;45:7-12.
- [149] Kiss AA, Flores Landaeta SJ, Infante Ferreira CA. Mastering Heat Pumps Selection for Energy Efficient Distillation. *Chemical Engineering Transactions*. 2012;29:397-402.
- [150] Annex 35 IEA. Application of Industrial Heat Pumps, Final report, Part 1. 2014.
- [151] Jacob R, Riahi S, Liu M, Belusko M, Bruno F. Technoeconomic Impacts of Storage System Design on the Viability of Concentrated Solar Power Plants. *Journal of Energy Storage*. 2021;34:101987.
- [152] Alfa Laval. <https://www.alfalaval.com/packinox>.
- [153] Fredsted LB. Processing systems for fruit juice and related products. In: Ashurst PR, editor. *Production and Packaging of Non-Carbonated Fruit Juices and Fruit Beverages*. Boston, MA: Springer US; 1999. p. 274-89.
- [154] Alfa Laval - Printed circuit heat exchanger. Alfa Laval Website 2021.
- [155] Shell and Tube Heat Exchangers. Mezzo Technologies Website 2021.
- [156] Industrial Products. 2021.
- [157] Noble R, Dombrowski K, Bernau M, Morett D, Maxson A, Hume S. Development of a Field Demonstration for Cost-Effective Low-Grade Heat Recovery and Use Technology Designed to Improve Efficiency and Reduce Water Usage Rates for a Coal-Fired Power Plant. ; Southern Company Services, Incorporated, Birmingham, AL (United States); 2016. p. Medium: ED; Size: 109 p.
- [158] Krönauer A, Lävemann E, Brückner S, Hauer A. Mobile Sorption Heat Storage in Industrial Waste Heat Recovery. *Energy Procedia*. 2015;73:272-80.

- [159] Bert den Ouden NL, Jort van Aken, Maarten Afman, Harry Croezen, Marit van Lieshout, Egbert Klop, René Waggeveld, Jan Grift. Electrification in the Dutch Process Industry. Netherlands Enterprise Agency; 2017.
- [160] Clark JP. Electromagnetic Energy in Food Processing. Food Technology Magazine. Online: Institute of Food Technologists; 2013.
- [161] Koutchma T. Application of infrared and light-based technologies to meat and meat products. Emerging Technologies in Meat Processing 2017. p. 131-47.
- [162] El-Mashad H, Pan Z. Application of Induction Heating in Food Processing and Cooking. Food Engineering Reviews. 2017;9.
- [163] Puschner Chamber Ovens. Puschner Website 2021.
- [164] Puschner Conti Heater and Conti Dryer. Puschner Website; 2021.
- [165] Systems G. Technical Information. 2021.
- [166] Schoeneberger CA, McMillan CA, Kurup P, Akar S, Margolis R, Masanet E. Solar for industrial process heat: A review of technologies, analysis approaches, and potential applications in the United States. Energy. 2020;206:118083.
- [167] Australia B. About BioEnergy. 2021.
- [168] Wei-Cheng Wang LT, Jennifer Markham, Yanan Zhang, Eric Tan, Liaw Batan, Ethan Warner, and Mary Bidy. Review of Biojet Fuel Conversion Technologies. National Renewable Energy Laboratory 2016.
- [169] ASTRI. Australian Solar Thermal Research Institute (ASTRI) Public Dissemination Report 2019. 2019.
- [170] Jacob R, Short M, Belusko M, Bruno F. Maximising renewable gas export opportunities at wastewater treatment plants through the integration of alternate energy generation and storage options. Science of The Total Environment. 2020;742:140580.
- [171] Valenzuela L. 12 - Thermal energy storage concepts for direct steam generation (DSG) solar plants. In: Blanco MJ, Santigosa LR, editors. Advances in Concentrating Solar Thermal Research and Technology: Woodhead Publishing; 2017. p. 269-89.
- [172] Okazaki T. Electric thermal energy storage and advantage of rotating heater having synchronous inertia. Renewable Energy. 2020;151:563-74.
- [173] EnergyNest - Member of the World Alliance. SolarImpulse Website 2021.
- [174] González-Roubaud E, Pérez-Osorio D, Prieto C. Review of commercial thermal energy storage in concentrated solar power plants: Steam vs. molten salts. Renewable and Sustainable Energy Reviews. 2017;80:133-48.
- [175] <http://dry-f.eu/>.
- [176] Chamoun M, Rulliere R, Haberschill P, Peureux J-L. Experimental and numerical investigations of a new high temperature heat pump for industrial heat recovery using water as refrigerant. International Journal of Refrigeration. 2014;44:177-88.
- [177] Bobelin D, Bourig A. Experimental results of a newly developed very high temperature industrial heat pump (140°C) equipped with scroll compressors and working with a new blend refrigerant. 14<sup>th</sup> International Refrigeration and Air Conditioning Conference. West Lafayette, IN, United States 2012.
- [178] Goji Food Solution. <http://www.gojifoodsolutions.com/rf-cooking-technology>.
- [179] Serio M, Cosgrove JE, Wójtowicz MA, Wignarajah K, Fisher JW. A Prototype Microwave Pyrolyzer for Solid Wastes. 43rd International Conference on Environmental Systems: American Institute of Aeronautics and Astronautics; 2013.
- [180] Gorjian S, Ebadi H, Calise F, Shukla A, Ingraio C. A review on recent advancements in performance enhancement techniques for low-temperature solar collectors. Energy Conversion and Management. 2020;222:113246.
- [181] Wang P-Y, Li S-F, Liu Z-H. Collecting performance of an evacuated tubular solar high-temperature air heater with concentric tube heat exchanger. Energy Conversion and Management. 2015;106:1166-73.

- [182] Liu Z-H, Hu R-L, Lu L, Zhao F, Xiao H-s. Thermal performance of an open thermosyphon using nanofluid for evacuated tubular high temperature air solar collector. *Energy Conversion and Management*. 2013;73:135-43.
- [183] Singh S, Gill RS, Hans VS, Singh M. A novel active-mode indirect solar dryer for agricultural products: Experimental evaluation and economic feasibility. *Energy*. 2021;222:119956.
- [184] Malakar S, Arora VK, Nema PK. Design and performance evaluation of an evacuated tube solar dryer for drying garlic clove. *Renewable Energy*. 2021;168:568-80.
- [185] Aramesh M, Shabani B. On the integration of phase change materials with evacuated tube solar thermal collectors. *Renewable and Sustainable Energy Reviews*. 2020;132:110135.
- [186] Chopra K, Pathak AK, Tyagi VV, Pandey AK, Anand S, Sari A. Thermal performance of phase change material integrated heat pipe evacuated tube solar collector system: An experimental assessment. *Energy Conversion and Management*. 2020;203:112205.
- [187] Zhao Y, Zhao CY, Markides CN, Wang H, Li W. Medium- and high-temperature latent and thermochemical heat storage using metals and metallic compounds as heat storage media: A technical review. *Applied Energy*. 2020;280:115950.
- [188] <https://www.cctenergystorage.com>.
- [189] <https://1414degrees.com.au>.
- [190] Laing D, Bahl C, Bauer T, Lehmann D, Steinmann W-D. Thermal energy storage for direct steam generation. *Solar Energy*. 2011;85:627-33.
- [191] Michels H, Pitz-Paal R. Cascaded latent heat storage for parabolic trough solar power plants. *Solar Energy*. 2007;81:829-37.
- [192] Yuan F, Li M-J, Ma Z, Jin B, Liu Z. Experimental study on thermal performance of high-temperature molten salt cascaded latent heat thermal energy storage system. *International Journal of Heat and Mass Transfer*. 2018;118:997-1011.
- [193] Zipf V, Neuhäuser A, Willert D, Nitz P, Gschwander S, Platzer W. High temperature latent heat storage with a screw heat exchanger: Design of prototype. *Applied Energy*. 2013;109:462-9.
- [194] Zipf V, Willert D, Neuhauser A. Chapter 5 - Dynamic Concept at Fraunhofer. In: Cabeza LF, Tay NHS, editors. *High Temperature Thermal Storage Systems Using Phase Change Materials*: Academic Press; 2018. p. 109-28.
- [195] Tay NHS, Belusko M, Liu M, Bruno F. Chapter 7 - Static Concept at University of South Australia. In: Cabeza LF, Tay NHS, editors. *High Temperature Thermal Storage Systems Using Phase Change Materials*: Academic Press; 2018. p. 157-91.
- [196] Gasia J, Miró L, de Gracia A, Cabeza LF. Chapter 6 - Static Concept at University of Lleida. In: Cabeza LF, Tay NHS, editors. *High Temperature Thermal Storage Systems Using Phase Change Materials*: Academic Press; 2018. p. 131-56.
- [197] Highview Power Storage Inc. *Liquid Air Energy Storage*. Highview Power Storage Inc.; 2017.
- [198] Schmidt M, Szczukowski C, Roßkopf C, Linder M, Wörner A. Experimental results of a 10 kW high temperature thermochemical storage reactor based on calcium hydroxide. *Applied Thermal Engineering*. 2014;62:553-9.
- [199] Schmidt M, Gollsch M, Giger F, Grün M, Linder M. Development of a moving bed pilot plant for thermochemical energy storage with CaO/Ca(OH)<sub>2</sub>. *AIP Conference Proceedings*. 2016;1734:050041.
- [200] Yan J, Zhao CY. Experimental study of CaO/Ca(OH)<sub>2</sub> in a fixed-bed reactor for thermochemical heat storage. *Applied Energy*. 2016;175:277-84.
- [201] GAS-TESS | 1414 Degrees. 1414 Degrees Website 2021.
- [202] Fernández AI, Barreneche C, Miró L, Brückner S, Cabeza LF. 19 - Thermal energy storage (TES) systems using heat from waste. In: Cabeza LF, editor. *Advances in Thermal Energy Storage Systems*: Woodhead Publishing; 2015. p. 479-92.
- [203] Tijani H, Nijeholt JALà, Spoelstra S. Development of a thermoacoustic heat pump for distillation column. 2017.
- [204] Wu S, Li TX, Yan T, Wang RZ. Advanced thermochemical resorption heat transformer for high-efficiency energy storage and heat transformation. *Energy*. 2019;175:1222-33.



- [205] Michel B, Clause M. Design of thermochemical heat transformer for waste heat recovery: Methodology for reactive pairs screening and dynamic aspect consideration. *Energy*. 2020;211:118042.
- [206] Reißner F, Gromoll B, Sch€afer J, Danov V, Karl J. Experimental performance evaluation of new safe and environmentally friendly working fluids for high temperature heat pumps. *European Heat Pump Summit*2013.
- [207] Altemimi A, Aziz SN, Al-Hilphy ARS, Lakhssassi N, Watson DG, Ibrahim SA. Critical review of radio-frequency (RF) heating applications in food processing. *Food Quality and Safety*. 2019;3:81-91.
- [208] Tang J, Resurreccion FP. 1 - Electromagnetic basis of microwave heating. In: Lorence MW, Pesheck PS, editors. *Development of Packaging and Products for Use in Microwave Ovens*: Woodhead Publishing; 2009. p. 3-38e.
- [209] Gauß R, Homm G, Gutfleisch O. The Resource Basis of Magnetic Refrigeration. *Journal of Industrial Ecology*. 2017;21:1291-300.
- [210] Zhang T, Qian X-S, Gu H, Hou Y, Zhang QM. An electrocaloric refrigerator with direct solid to solid regeneration. *Applied Physics Letters*. 2017;110:243503.
- [211] Cui J, Wu Y, Muehlbauer J, Hwang Y, Radermacher R, Fackler S, et al. Demonstration of high efficiency elastocaloric cooling with large  $\Delta T$  using NiTi wires. *Applied Physics Letters*. 2012;101:073904.
- [212] Kumar N. *Review of Innovation Diffusion Models*2015.
- [213] Rogers EM. *Diffusion of innovations*: Macmillan Publishing Co., Inc.; 1983.
- [214] Department of Industry S, Energy, and Resources. *National Greenhouse Accounts Factors*: 2020. Australian Government; 2020.
- [215] Resources CE. *Delivered Wholesale Gas Price Outlook 2020-2050*. Australian Energy Market Operator; 2019.
- [216] Chatfield R. *Renewables and Electrification in Alumina Refining*. 2020 Energy and Mines Conference2020.
- [217] Commonwealth of Australia. *Australian Energy Update*. 2020.
- [218] Australian Government Department of Industry, Science, Energy and Resources,. *National Greenhouse Accounts Factors*. 2020.
- [219] Nolan G, Innes T, Redman A, McGavin R. *Australian Hardwood Drying Best Practice Manual. Part 2: Forest and Wood Products Research and Development Corporation*; 2003.
- [220] Martínez González A, Lesme Jaén R, Silva Lora EE. Thermodynamic assessment of the integrated gasification-power plant operating in the sawmill industry: An energy and exergy analysis. *Renewable Energy*. 2020;147:1151-63.
- [221] Australian Bureau of Agricultural and Resource Economics.
- [222] Australian Government Bureau of Meteorology. *Maps of average conditions*.
- [223] Office of the Tasmanian Economic Regulator. *ENERGY IN TASMANIA REPORT 2018-19*. 2020.
- [224] Timberbiz. *Wespine replaces 5 kilns with one super kiln*. Australian Forests & Timber News: Ryan Media Pty Ltd; 2019.
- [225] Enqvist E. *Impregnation, Vapor Phase and Methanol as Means of Intensifying the Softwood Kraft Pulping Process*. 951-22-8406-5. 2006.
- [226] SUHR M, KLEIN G, KOURTI I, RODRIGO GONZALO M, GINER SANTONJA G, ROUDIER S, et al. *Best Available Techniques (BAT) Reference Document for the Production of Pulp, Paper and Board. Industrial Emissions Directive 2010/75/EU (Integrated Pollution Prevention and Control)*. 2015.
- [227] Maniatis K. *ExCo54 Workshop :Black Liquor Gasification. Summary and Conclusions.*: IEA Bioenergy; 2007.
- [228] Bajpai P. Chapter 19 - Pulp Bleaching. In: Bajpai P, editor. *Biermann's Handbook of Pulp and Paper (Third Edition)*: Elsevier; 2018. p. 465-91.
- [229] Haasteren Tv. *High Temperature Heat Pump for increased sustainability papermachines*. 12th IEA Heat Pump Conference. Rotterdam2017.

- [230] Australian Paper, SUEZ. Australian Paper and SUEZ partner on \$600M Energy from Waste project. 2019.
- [231] Hagelqvist A. Sludge from pulp and paper mills for biogas production - Strategies to improve energy performance in wastewater treatment and sludge management. Karlstad, Sweden: Karlstad University; 2013.
- [232] Bakraoui M, Karouach F, Ouhammou B, Aggour M, Essamri A, El Bari H. Biogas production from recycled paper mill wastewater by UASB digester: Optimal and mesophilic conditions. *Biotechnology Reports*. 2020;25:e00402.
- [233] DairyAustralia. Dairy Situation and Outlook. Dairy Australia Limited; 2021.
- [234] Beyond Zero Emissions. Zero Carbon Industry Plan-Electrifying Industry. 2018.
- [235] Dairy Australia. Situation and Outlook Report. 2021.
- [236] Australian Alliance for Energy Productivity (A2EP). A guide for business: replacing steam with electricity technologies to boost energy productivity. 2018.
- [237] Meat & Livestock Australia. The red meat industry. 2020.
- [238] Australian Meat Processor Corporation (AMPC). Annual Report 2019–2020. 2021.
- [239] Australian Bureau of Statistics. Livestock and Meat, Australia, Table 13. 2020.
- [240] Australian Meat Processor Corporation (AMPC). Environmental Performance Review: Red Meat Processing Sector 2015. 2015.
- [241] Ware A, Power N. Biogas from cattle slaughterhouse waste: Energy recovery towards an energy self-sufficient industry in Ireland. *Renewable Energy*. 2016;97:541-9.
- [242] IBISWorld. AU INDUSTRY (ANZSIC) REPORT C1212: Beer Manufacturing in Australia. 2021.
- [243] Acil Allen Consulting. Economic contribution of the Australian brewing industry 2017-18: From producers to consumers. 2019.
- [244] Australian Bureau of Statistics. Apparent Consumption of Alcohol, Australia. 2019.
- [245] Burnett C. Beer volume decline to hit big brewers say analysts. *BrewsNews*2019.
- [246] Victoria Bitter. Swap solar power for VB in Aussie-first program. *Diamond Energy*2021.
- [247] Brewers Association of Australia. Sustainable beer production. 2019.
- [248] Summers J. These Australian breweries are powered by solar. . *Origin Energy*; 2018.
- [249] Efficiency DoCCaE. Baseline Energy Consumption and Greenhouse Gas Emissions Commercial Buildings Australia. 2021.
- [250] Chris Dunstan EL, Nicky Ison. 20 Policy Options for Developing Distributed Energy. *Institute for Sustainable Futures: iGrid*; 2009.
- [251] Chris Dunstan JD, Edward Langham, Louise Boronyak, Jay Rutovitz. Institutional Barriers to Intelligent Grid. *Institutional Barriers to Intelligent Grid: iGrid*; 2011.
- [252] Dickinson RM, Cruickshank CA. Review of Combined Space and Domestic Hot Water Heating Systems for Solar Applications. *ASME 2011 5th International Conference on Energy Sustainability*2011. p. 205-11.
- [253] Chandel SS, Agarwal T. Review of current state of research on energy storage, toxicity, health hazards and commercialization of phase changing materials. *Renewable and Sustainable Energy Reviews*. 2017;67:581-96.
- [254] Janz GJ, Allen CB, Bansal N, Murphy R, Tomkins R. Physical properties data compilations relevant to energy storage, 2. Molten salts: Data on single and multi-component salt systems. *Nasa Sti/recon Technical Report N*. 1979;80:10643.
- [255] Singhvi MS, Gokhale DV. Lignocellulosic biomass: hurdles and challenges in its valorization. *Applied microbiology and biotechnology*. 2019;103:9305-20.
- [256] Klein-Marcuschamer D, Blanch HW. Renewable fuels from biomass: technical hurdles and economic assessment of biological routes. *AIChE Journal*. 2015;61:2689-701.
- [257] Dutta S. Deoxygenation of biomass-derived feedstocks: hurdles and opportunities. *ChemSusChem*. 2012;5:2125-7.

- [258] Zurita A, Mata-Torres C, Valenzuela C, Felbol C, Cardemil JM, Guzmán AM, et al. Techno-economic evaluation of a hybrid CSP+ PV plant integrated with thermal energy storage and a large-scale battery energy storage system for base generation. *Solar Energy*. 2018;173:1262-77.
- [259] Johnson M, Vogel J, Hempel M, Dengel A, Seitz M, Hachmann B. High temperature latent heat thermal energy storage integration in a co-gen plant. *Energy Procedia*. 2015;73:281-8.
- [260] Powell KM, Kim JS, Cole WJ, Kapoor K, Mojica JL, Hedengren JD, et al. Thermal energy storage to minimize cost and improve efficiency of a polygeneration district energy system in a real-time electricity market. *Energy*. 2016;113:52-63.
- [261] Ooka R, Ikeda S. A review on optimization techniques for active thermal energy storage control. *Energy and Buildings*. 2015;106:225-33.
- [262] Cole WJ, Powell KM, Edgar TF. Optimization and advanced control of thermal energy storage systems. *Reviews in Chemical Engineering*. 2012;28:81-99.
- [263] Australian Alliance for Energy Productivity. High Temperature Heat Pumps for the Australian food industry: Opportunities assessment. August 2017.
- [264] ITP, Pitt & Sherry, Institute for Sustainable Futures-UTS, beyond Zero emissions. Renewable energy options for industrial process heat. November 2019.
- [265] UIP 12. Miscellaneous Industrial Costs. 2003.
- [266] Cella L. Electrifying Industry New Opportunity for Improving Energy Efficiency. *Pump Industry*; 2019.
- [267] Australian Alliance for Energy Productivity. A guide for business: Replacing steam with electricity technologies to boost energy productivity. 2018.
- [268] Core Energy and Resources. Delivered Wholesale Gas Price Outlook 2019-2040, Residential & Commercial and Gas Generation Segments. January 2019.
- [269] CSIRO. Electricity generation technology cost projections. 2017.
- [270] Australian Alliance For Energy Productivity, Climate-KIC Australia. Renewable Energy for Process Heat Opportunity Study. May 2020.
- [271] IEA. Application of Industrial Heat Pumps, Annexe 35, Part 2. 2014.
- [272] GREBE. Advice Notes on Solar Thermal Technology Economics for the NPA Region. 2017.
- [273] AEMO. Final 2020 Integrated System Plan. 2020.
- [274] Regulator AE. State of the energy Market 2020. 2020.
- [275] Jacobs Pa. The Future of Energy. 2019.
- [276] Business Renewables Center Australia. Corporate Renewable Power Purchase Agreements in Australia - State of the Market 2019. 2019.
- [277] AEMO. 2020 Electricity Statement of Opportunities. 2020.
- [278] AEMO. Data (NEM). 2020.
- [279] S. Karimi-Arpanahi MJ, M. Moeini-Aghtaie, A. Abbaspour, and M. Fotuhi-Firuzabad. Incorporating flexibility requirements into distribution system expansion planning studies based on regulatory policies. *International Journal of Electrical Power Energy System*. October 2019;118:105769.
- [280] D. C. Wu AA, A. Razban, and J. Chen. ARC algorithm: A novel approach to forecast and manage daily electrical maximum demand. *Energy*. 2018;154:383-9.
- [281] N. Christiansen MK, F. Dzukowski, and F. Isensee. Electricity consumption of medical plug loads in hospital laboratories: Identification, evaluation, prediction and verification. *IEnergy Build*. 2015;107:392-406.
- [282] IRENA. Innovation landscape brief: Renewable power-to-heat. 2019.
- [283] Australia CCI. CCIA Projections Technical Report.
- [284] Lab NRE. Electrification Futures Study: Scenarios of Power System Evolution and Infrastructure Development for the United States. 2021. p. 105769.
- [285] A. Tabandeh AA, and M. Rashidinejad. Reliability constrained congestion management with uncertain negawatt demand response firms considering repairable advanced metering infrastructures. *Energy*. 2016;104:213-28.

- [286] M. Yao IAH, and J. L. Mathieu. Improving Power System Voltage Stability by Using Demand Response to Maximize the Distance to the Closest Saddle-Node Bifurcation. IEEE Conference on Decision and Control 2019. p. 2390-5.
- [287] AEMO. AEMO observations: Operational and market challenges to reliability and security in the NEM. March 2018.
- [288] Energy Security Board CEC. Post 2025 Market Design Consultation Paper. September 2020.
- [289] AEMC. Fact sheet: How the spot market works. November 2017.
- [290] AEMO. 2020 Network Support and Control Ancillary Services (NSCAS) Report. December 2020.
- [291] AEMO. 2020 Integrated System Plan. July 2020.
- [292] IRENA. Adapting Market Design to High Shares of Variable Renewable Energy. 2017.
- [293] P/L GET. Managing Flexibility Whilst Decarbonising Electricity - The Australian NEM is changing. 2017.
- [294] Dunstan C, Alexander D, Morris T, Langham E, Jazbec M. Demand Management Incentives Review, ISF-UTS. 2017.
- [295] IRENA. Demand-Side Flexibility For Power Sector Transformation. 2019.
- [296] eia. <https://www.eia.gov/todayinenergy/detail.php?id=45476>. October 15, 2020.
- [297] Liu Y, You S, Gong M, Zhang Y, Liu Y, Bennett M, et al. Frequency response assessment and improvement of three major North American interconnections due to high penetrations of photovoltaic generation. Workshop on grid forming inverters for low inertia power systems, Seattle. 2019.
- [298] Roesch M, Bauer D, Haupt L, Keller R, Bauernhansl T, Fridgen G, et al. Harnessing the Full Potential of Industrial Demand-Side Flexibility: An End-to-End Approach Connecting Machines with Markets through Service-Oriented IT Platforms. Applied Sciences. 2019;2009:3796.
- [299] AEMC. National Electricity Amendment (Wholesale Demand Response Mechanism) Rule 2020. June 2020.
- [300] Energetics. Overview of the demand response market in Australia - Stage 1 deliverable. 2021.
- [301] AEMO. Wholesale Demand Response: High-level Design. June 2020.
- [302] AEMC. Rule Determination - National Electricity Amendment (Five Minute Settlement) Rule 2017. November 2017.
- [303] Heffron R, Körner M-F, Wagner J, Weibelzahl M, Fridgen G. Industrial demand-side flexibility: A key element of a just energy transition and industrial development. Applied Energy. 2020;269:115026.
- [304] J. Prendergast, S. Dwyer, C. Briggs, T. Morris, C. Dunstan. Best of Both Worlds: Renewable Energy and Load Flexibility for Australian Business Customers, ISF-UTS. 2018.
- [305] Löbbe S, Hackbarth A, Hagenlocher H, Ziegler U. Chapter 16 - Industrial demand flexibility: A German case study. In: Sioshansi F, editor. Variable Generation, Flexible Demand: Academic Press; 2021. p. 371-89.
- [306] Energeia. Expert Advice on the Cost of Establishing a Second Connection Point. 2020.
- [307] Ausgrid. <https://www.ausgrid.com.au/Connections/Get-connected>.
- [308] Ausgrid. <https://www.ausgrid.com.au/Connections/solar-battery-and-embedded-generation>.
- [309] AEMO. <https://www.aemc.gov.au/energy-system/electricity/electricity-system/reliability>.
- [310] Clean Energy Regulator. <http://www.cleanenergyregulator.gov.au/RET/About-the-Renewable-Energy-Target>.
- [311] Clean Energy Council. <https://www.cleanenergycouncil.org.au/advocacy-initiatives/renewable-energy-target>.
- [312] Council CE. Clean Energy Australia. 2021.
- [313] Government VS. Victoria's Renewable Energy Targets. 2021.
- [314] Australian Government - Climate Change Authority. Renewable Energy Target Review. December 2012.
- [315] The CIE. The Renewable Energy Target - How it works and what it costs. 2013.
- [316] Jackeline Peel, Lee C. Godden, Keenan RJ. Australia's Carbon Pricing Mechanism. Climate Law. May 2012;052:1-12.

- [317] The Guardian. <https://www.theguardian.com/commentisfree/2021/feb/15/australias-lack-of-effort-on-climate-change-is-going-to-cost-us>.
- [318] Centre for Climate and Energy Solutions. Australia's Carbon Pricing Mechanism. December 2011.
- [319] Clean Energy Regulator. <http://www.cleanenergyregulator.gov.au/ERF/About-the-Emissions-Reduction-Fund>.
- [320] Beyond Zero Emissions. Electrifying Industry. 2018.
- [321] Australian Building Codes Board. Building Code of Australia. 2019.
- [322] NABERS. <https://www.nabers.gov.au/>.
- [323] Australian Building Codes Board. Energy efficiency: NCC 2022 and beyond. 2019.
- [324] Global Efficiency Intelligence DGA. Electrifying U.S. Industry: A Technology- and Process-Based Approach to Decarbonization. 2021.
- [325] IRENA, IEA, REN21. Renewable Energy Policies in a Time of Transition. 2018.
- [326] (A2EP) AAfEP. A Roadmap to Double Energy Productivity in Manufacturing by 2030. Australian Alliance for Energy Productivity; 2016.
- [327] (A2EP) AAfEP. The Next Wave -- Innovation to Double Energy Productivity by 2030. Australian Alliance for Energy Productivity; 2017.
- [328] J K, S S, Boyd R, Ashby B, Steele K. Health Care's Climate Footprint How the Health Sector Contributes. 2019. p. 48-.
- [329] Nugent D, Sovacool BK. Assessing the lifecycle greenhouse gas emissions from solar PV and wind energy: A critical meta-survey. Energy Policy. 2014;65:229-44.
- [330] NREL. Life Cycle Greenhouse Gas Emissions from Solar Photovoltaics. 2012.
- [331] World Nuclear A. Comparison of Lifecycle Greenhouse Gas Emissions of Various Electricity Generation Sources. 2011. p. 10-.
- [332] Louwen A, Van Sark WGJHM, Faaij APC, Schropp REI. Re-assessment of net energy production and greenhouse gas emissions avoidance after 40 years of photovoltaics development. Nature Communications. 2016;7:1-9.
- [333] NABERS Energy and Water for hospitals: Rules for collecting and using data. Office of Environment and Heritage; 2017.
- [334] Building Code of A. National Construction Code 2019 Volume 1. Australian Building Codes Board; 2019. p. 750-.
- [335] AEMO. Carbon dioxide equivalent intensity index. 2021.
- [336] Australian Energy Market O. Carbon dioxide equivalent intensity index. AEMO; 2020.
- [337] Australian Bureau of S. Australia Private Hospitals. Canberra, Australia 2018.
- [338] Arena. Solar Energy - Australian Renewable Energy Agency. 2021. p. 6-.
- [339] Health Care Without Harm. Health Care Without Harm Web Page 2021.
- [340] Global Green and Healthy Hospitals. Global Green and Health Hospitals Web Page 2021.
- [341] Deason J, Wei, M., Leventis, G., Smith, S., Schwartz, L. . Electrification of buildings and industry in the United States: Drivers, barriers, prospects, and policy approaches. . Lawrence Berkeley National Laboratory Energy Analysis and Environmental Impacts Division. ; 2018.
- [342] Whitlock A, Elliott, N., Rightor, E. Transforming Industry: Paths to Industrial Decarbonization in the United States. . American Council for an Energy Efficient Economy (ACEEE); 2020.
- [343] J. A. Short DGI, and L. L. Freris. Stabilization of grid frequency through dynamic demand control. IEEE Transactions on Power Systems. 2007;22:1284-93.

## Appendix A: Market Status Survey Sample

This appendix contains a sample survey which pertains to the food manufacturing sector. Other surveys were sent to sugar, meat, beverage, wood product, paper/pulp, polymer product, non-ferrous manufacturing, as well as commercial building sectors.



**RACE for 2030 Theme B3 - Survey of End Users (Food Manufacturing)**

As part of the RACE for 2030 B3 Theme we are trying to better understand opportunities for electrification and renewables to displace fossil fuel process heating

This survey seeks to identify opportunities for electrification and decarbonisation of process heat in Australia. The purpose of this survey is to map, in finer detail than previous work, the current process heat technologies, practices and needs of Australian companies, at a company level. This information will be used to assist in the development of an industry roadmap for the decarbonisation of process heat in Australia, with a focus on actions that could be implemented in the period 2020 – 2030.

The survey has two parts. Part A relates to general business information while Part B focuses on technical details about process heat applications and operations in your company. Both parts will help to build a picture of the range of business practices and needs within this industry sector. This information, in turn, will help to inform strategies that are specific to the sector and implementable at a company level.

You may wish one person to complete the survey, or multiple people to respond to different parts of the survey. It doesn't matter if any particular question is unanswered or answered by multiple people. We do not expect you to reveal information that you consider commercially sensitive, so don't feel obliged to answer every question. Your company's name will only be used for the purpose of identifying multiple responses from the same company. The company name will NOT be used in any analysis or public reporting. Persons responding to the survey do not need to reveal their identity.

The data you supply (excluding your company name) may be shared with A2EP's research partners and analysis results published in research reports and/or material as part of the RACE program.

If you require any further information please don't hesitate to contact Laura Harkins-Small at [laura.harkins-small@a2ep.org.au](mailto:laura.harkins-small@a2ep.org.au)

Thankyou for your time and participation in advance.

1. Does your organisation use heat processes up to 250 degrees celsius?

Yes

No

2. What is the registered business name of your company? This information will only be used to help identify if more than one person has completed the survey from the same organisation. Responses to this question will not be kept with the remainder of the responses.



RACE for 2030 Theme B3 - Survey of End Users (Food Manufacturing)

About your organisation

3. Which industry/sector best describes your organisation (tick as many as apply)?

- Seafood processing
- Dairy product manufacturing
- Fruit and vegetable processing
- Oil and fat manufacturing
- Other (please specify)
- Grain mill and cereal product manufacturing
- Bakery product manufacturing
- Food Product Manufacturing - other

4. Please provide the postcode of your main sites (up to five) to help us determine broad geographic location that could impact on renewable energy potential and electricity grid constraints.

Site One

Site Two

Site Three

Site Four

Site Five

5. Which categories best describe your business (tick as many as apply)

- Small Business (0 to 20 employees)
- Medium (20 to 200 employees)
- Large (200 employees +)
- We are a single organisation
- We are owned/part of a larger conglomerate

6. Does your company have a goal to achieve net zero carbon ?

7. Is your company considering any greenfield development/s in the next 10 years?

8. Is your company considering any major plant upgrades in the next 10 years?

## Electrification & Renewables to Displace Fossil Fuel Process Heating

9. What financial mechanism is used in your company to decide the economic viability of a project (e.g. payback period, net present value etc)?

10. For your company, what are the main barriers and/or opportunities for decarbonising low temperature heat processes (up to 150°C)?

11. Does your company have an energy contract beyond standard industry tariff options? (This will help us determine if there are contractual issues that might be barriers to decarbonisation, and how long these barriers may be in place).

- Take or pay contract for gas
- Power purchase agreement for electricity
- Other
- No

Please specify expiry year of contract if possible

12. To help determine the range of energy costs that impact on businesses in this sector, please indicate the unit cost for gas (MJ) and electricity (kWh) that you currently pay as applicable (approximations are ok).

Gas (MJ)	<input type="text"/>
Electricity daily charge	<input type="text"/>
Electricity flat tariff	<input type="text"/>
Electricity off peak	<input type="text"/>
Electricity shoulder	<input type="text"/>
Electricity peak	<input type="text"/>
Network daily charge	<input type="text"/>
Network off peak charge	<input type="text"/>
Network peak demand charge (kW or kVA)	<input type="text"/>





RACE for 2030 Theme B3 - Survey of End Users (Food Manufacturing)

PART B – TECHNICAL INFORMATION ABOUT PROCESS HEAT NEEDS

In this section we're interested in building a detailed picture of the range of energy sources and processes used in your sector.

13. We're interested in knowing roughly how much energy individual companies in this sector use for process heat per year. Please provide an estimate of your annual process heat usage:

Gas (GJ)

Electricity (MWh)

14. In order to help identify decarbonisation pathways, we need to know what energy sources are currently being used by businesses in your sector. Please indicate what energy source is used for processes in the temperature ranges relevant to your company. Click on the rows and columns that apply to your company.

	<95°C	95-150°C	150-250°C
Coal or coal product	<input type="checkbox"/>	<input type="checkbox"/>	<input type="checkbox"/>
Gas (natural or LPG)	<input type="checkbox"/>	<input type="checkbox"/>	<input type="checkbox"/>
Diesel	<input type="checkbox"/>	<input type="checkbox"/>	<input type="checkbox"/>
Fuel oil	<input type="checkbox"/>	<input type="checkbox"/>	<input type="checkbox"/>
Biomass (e.g. bagasse, wood waste, pulp)	<input type="checkbox"/>	<input type="checkbox"/>	<input type="checkbox"/>
Municipal waste / other waste	<input type="checkbox"/>	<input type="checkbox"/>	<input type="checkbox"/>
Solar thermal	<input type="checkbox"/>	<input type="checkbox"/>	<input type="checkbox"/>
Electricity for heat (from grid)	<input type="checkbox"/>	<input type="checkbox"/>	<input type="checkbox"/>
Electricity for heat (from onsite generation)	<input type="checkbox"/>	<input type="checkbox"/>	<input type="checkbox"/>

Other energy sources and associated heat range

## Electrification & Renewables to Displace Fossil Fuel Process Heating

15. Indicate the processes, and associated temperatures, incorporated into your company's processes. Tick the columns that apply to each of the relevant processes.

	<95°C	95-150°C	150-250°C
Curing	<input type="checkbox"/>	<input type="checkbox"/>	<input type="checkbox"/>
Food preparation e.g. peeling	<input type="checkbox"/>	<input type="checkbox"/>	<input type="checkbox"/>
Cooking: blanching, boiling (water)	<input type="checkbox"/>	<input type="checkbox"/>	<input type="checkbox"/>
Cooking: baking / roasting (air)	<input type="checkbox"/>	<input type="checkbox"/>	<input type="checkbox"/>
Cooking: frying (oil)	<input type="checkbox"/>	<input type="checkbox"/>	<input type="checkbox"/>
Pasteurisation	<input type="checkbox"/>	<input type="checkbox"/>	<input type="checkbox"/>
Sterilisation	<input type="checkbox"/>	<input type="checkbox"/>	<input type="checkbox"/>
Drying	<input type="checkbox"/>	<input type="checkbox"/>	<input type="checkbox"/>
Washing / Cleaning	<input type="checkbox"/>	<input type="checkbox"/>	<input type="checkbox"/>

Other Processes & Associated Heat Range

## Electrification & Renewables to Displace Fossil Fuel Process Heating

16. Indicate, for the processes used by your company, what secondary source/s of energy are used for each process. This is typically through indirect heating (using steam, water, air, oil) or direct heating of the product.

	Steam	Water	Air	Oil or other fluid	Heat applied directly to the material
Curing	<input type="checkbox"/>	<input type="checkbox"/>	<input type="checkbox"/>	<input type="checkbox"/>	<input type="checkbox"/>
Food preparation e.g. peeling	<input type="checkbox"/>	<input type="checkbox"/>	<input type="checkbox"/>	<input type="checkbox"/>	<input type="checkbox"/>
Cooking: blanching, boiling (water)	<input type="checkbox"/>	<input type="checkbox"/>	<input type="checkbox"/>	<input type="checkbox"/>	<input type="checkbox"/>
Cooking: baking / roasting (air)	<input type="checkbox"/>	<input type="checkbox"/>	<input type="checkbox"/>	<input type="checkbox"/>	<input type="checkbox"/>
Cooking: frying (oil)	<input type="checkbox"/>	<input type="checkbox"/>	<input type="checkbox"/>	<input type="checkbox"/>	<input type="checkbox"/>
Pasteurisation	<input type="checkbox"/>	<input type="checkbox"/>	<input type="checkbox"/>	<input type="checkbox"/>	<input type="checkbox"/>
Sterilisation	<input type="checkbox"/>	<input type="checkbox"/>	<input type="checkbox"/>	<input type="checkbox"/>	<input type="checkbox"/>
Drying	<input type="checkbox"/>	<input type="checkbox"/>	<input type="checkbox"/>	<input type="checkbox"/>	<input type="checkbox"/>
Washing / Cleaning	<input type="checkbox"/>	<input type="checkbox"/>	<input type="checkbox"/>	<input type="checkbox"/>	<input type="checkbox"/>

Other processes & heat method



RACE for 2030 Theme B3 - Survey of End Users (Food Manufacturing)

Process scheduling

To determine what decarbonisation or renewable energy technologies might be most suitable, we need to understand something about how each of your processes operates. This includes the type and duration of different processes, and the scheduling of those processes.

17. Indicate for each process, whether the process is batch (all steps carried out with a single load in place, by adjusting the conditions over time) or continuous (various processes are carried out in succession in designated zones or locations). Also indicate the approximate duration of each process. To answer, click on the appropriate column for each row.

	Batch	Continuous	Process Duration ≤ 1 hr	Process Duration 1-6 hrs	Process Duration 6-12 hrs	Process Duration >12 hrs
Curing	<input type="checkbox"/>	<input type="checkbox"/>	<input type="checkbox"/>	<input type="checkbox"/>	<input type="checkbox"/>	<input type="checkbox"/>
Food preparation e.g. peeling	<input type="checkbox"/>	<input type="checkbox"/>	<input type="checkbox"/>	<input type="checkbox"/>	<input type="checkbox"/>	<input type="checkbox"/>
Cooking: blanching, boiling (water)	<input type="checkbox"/>	<input type="checkbox"/>	<input type="checkbox"/>	<input type="checkbox"/>	<input type="checkbox"/>	<input type="checkbox"/>
Cooking: baking / roasting (air)	<input type="checkbox"/>	<input type="checkbox"/>	<input type="checkbox"/>	<input type="checkbox"/>	<input type="checkbox"/>	<input type="checkbox"/>
Cooking: frying (oil)	<input type="checkbox"/>	<input type="checkbox"/>	<input type="checkbox"/>	<input type="checkbox"/>	<input type="checkbox"/>	<input type="checkbox"/>
Pasteurisation	<input type="checkbox"/>	<input type="checkbox"/>	<input type="checkbox"/>	<input type="checkbox"/>	<input type="checkbox"/>	<input type="checkbox"/>
Sterilisation	<input type="checkbox"/>	<input type="checkbox"/>	<input type="checkbox"/>	<input type="checkbox"/>	<input type="checkbox"/>	<input type="checkbox"/>
Drying	<input type="checkbox"/>	<input type="checkbox"/>	<input type="checkbox"/>	<input type="checkbox"/>	<input type="checkbox"/>	<input type="checkbox"/>
Washing / Cleaning	<input type="checkbox"/>	<input type="checkbox"/>	<input type="checkbox"/>	<input type="checkbox"/>	<input type="checkbox"/>	<input type="checkbox"/>

Other processes and durations (please specify)

## Electrification & Renewables to Displace Fossil Fuel Process Heating

18. For the same processes, please indicate the typical day and time of day for each process. To answer, click on the appropriate column for each row.

	Monday	Tuesday	Wednesday	Thursday	Friday	Saturday	Sunday	0:00 – 06:00	06:00 – 12:00	12:00 – 18:00	18:00 – 24:00
Curing	<input type="checkbox"/>	<input type="checkbox"/>	<input type="checkbox"/>	<input type="checkbox"/>	<input type="checkbox"/>	<input type="checkbox"/>	<input type="checkbox"/>	<input type="checkbox"/>	<input type="checkbox"/>	<input type="checkbox"/>	<input type="checkbox"/>
Food preparation e.g. peeling	<input type="checkbox"/>	<input type="checkbox"/>	<input type="checkbox"/>	<input type="checkbox"/>	<input type="checkbox"/>	<input type="checkbox"/>	<input type="checkbox"/>	<input type="checkbox"/>	<input type="checkbox"/>	<input type="checkbox"/>	<input type="checkbox"/>
Cooking: blanching, boiling (water)	<input type="checkbox"/>	<input type="checkbox"/>	<input type="checkbox"/>	<input type="checkbox"/>	<input type="checkbox"/>	<input type="checkbox"/>	<input type="checkbox"/>	<input type="checkbox"/>	<input type="checkbox"/>	<input type="checkbox"/>	<input type="checkbox"/>
Cooking: baking / roasting (air)	<input type="checkbox"/>	<input type="checkbox"/>	<input type="checkbox"/>	<input type="checkbox"/>	<input type="checkbox"/>	<input type="checkbox"/>	<input type="checkbox"/>	<input type="checkbox"/>	<input type="checkbox"/>	<input type="checkbox"/>	<input type="checkbox"/>
Cooking: frying (oil)	<input type="checkbox"/>	<input type="checkbox"/>	<input type="checkbox"/>	<input type="checkbox"/>	<input type="checkbox"/>	<input type="checkbox"/>	<input type="checkbox"/>	<input type="checkbox"/>	<input type="checkbox"/>	<input type="checkbox"/>	<input type="checkbox"/>
Pasteurisation	<input type="checkbox"/>	<input type="checkbox"/>	<input type="checkbox"/>	<input type="checkbox"/>	<input type="checkbox"/>	<input type="checkbox"/>	<input type="checkbox"/>	<input type="checkbox"/>	<input type="checkbox"/>	<input type="checkbox"/>	<input type="checkbox"/>
Sterilisation	<input type="checkbox"/>	<input type="checkbox"/>	<input type="checkbox"/>	<input type="checkbox"/>	<input type="checkbox"/>	<input type="checkbox"/>	<input type="checkbox"/>	<input type="checkbox"/>	<input type="checkbox"/>	<input type="checkbox"/>	<input type="checkbox"/>
Drying	<input type="checkbox"/>	<input type="checkbox"/>	<input type="checkbox"/>	<input type="checkbox"/>	<input type="checkbox"/>	<input type="checkbox"/>	<input type="checkbox"/>	<input type="checkbox"/>	<input type="checkbox"/>	<input type="checkbox"/>	<input type="checkbox"/>
Washing / Cleaning	<input type="checkbox"/>	<input type="checkbox"/>	<input type="checkbox"/>	<input type="checkbox"/>	<input type="checkbox"/>	<input type="checkbox"/>	<input type="checkbox"/>	<input type="checkbox"/>	<input type="checkbox"/>	<input type="checkbox"/>	<input type="checkbox"/>

Other processes and operation times

19. Is there any flexibility in the timing of the process/processes mentioned above? (e.g. can the process be timed for a different day / time if the technology and price signals were available)

- Yes
  Definitely not  
 Perhaps – will need some investigation
  Don't know  
 Unlikely

20. What equipment / devices does your company use in processes that require temperatures up to 150°C?

21. What floor area could you make available for a thermal storage tank?

- We would have less than 4 square metres  
 We would have between 4 and 20 square metres  
 We would have more than 20 square metres  
 Not sure  
 We wouldn't have any floor area available



RACE for 2030 Theme B3 - Survey of End Users (Food Manufacturing)

Energy flows, waste heat, equipment replacement

**In this section we are interested in knowing process heat flows and waste heat recovery practices in your plant, and any plans for equipment replacement in the near/medium term.**

22. Has your company mapped (documented) its process energy flows?

- No
- Yes, Sankey diagram
- Yes, mass and energy balances for process flow diagrams (PFDs)
- Don't know

Other (please specify)

23. Does your company do any waste heat recycling (capturing waste heat from a process and putting it into the same process) or waste heat recovery (capturing waste heat from process and putting it into another process)?

- Yes
- No
- Not sure

If yes, please provide a provide a brief description of how you use waste heat recycling/recovery.

24. Does your company have a refrigeration plant on site?

- Yes
- No
- Not sure

If yes, please provide a brief description about the type of refrigeration plant

## Electrification & Renewables to Displace Fossil Fuel Process Heating

25. Do you have any heat devices/equipment that is due approaching its end of life in the next five years? If so please list (up to five) below.

Name of plant &  
approximate life span left

Name of plant &  
approximate life span left

Name of plant &  
approximate life span left

Name of plant &  
approximate life span left

Name of plant &  
approximate life span left

26. Have you considered a particular alternative technology in the last 3 years? What? Did you take it up or not?



RACE for 2030 Theme B3 - Survey of End Users (Food Manufacturing)

27. Do you have any other comments or feedback around your organisations adoption of demand response strategies and technologies that might be helpful to our research?



## Appendix B: Summary of Uptake Scenario Modelling Data

The data below is a summary of the uptake scenario modelling data used in the market potential section. More specifically, the below data was used in Figure 97 and Figure 98.

Table 42: Summary of emission reduction from process heat for all sectors investigated in the current analysis for the accelerated scenario relative to business as usual

ACL Emission Reduction vs BaU (kilotonnes CO <sub>2,eq</sub> per annum)											
	Hotels	Healthcare	Beer Processing	Dairy Processing	Meat Processing	Alumina refining	Non-Ferrous Metals (ex Alumina)	Pulp and Paper	Wood drying	Other manufacturing	Approx. Total
<b>2019</b>	0.0	0.0	0.0	0.0	0.0	0.0	0.0	0.0	0.0	0.0	<b>0</b>
<b>2020</b>	0.0	0.0	0.0	0.0	0.0	0.0	0.0	0.0	0.0	0.0	<b>0</b>
<b>2021</b>	0.0	0.0	0.0	0.0	0.0	0.0	0.0	0.0	0.0	0.0	<b>0</b>
<b>2022</b>	16.9	11.8	1.9	1.4	9.6	12.8	5.1	1.8	0.2	3.0	<b>64.5</b>
<b>2023</b>	38.7	26.9	3.9	3.4	21.2	29.6	11.8	4.2	0.4	6.5	<b>146.6</b>
<b>2024</b>	66.5	46.1	6.1	6.1	34.9	51.5	20.5	7.2	0.7	10.7	<b>250.3</b>
<b>2025</b>	101.3	70.2	8.3	9.6	50.8	80.2	31.9	9.7	1.1	15.6	<b>378.7</b>
<b>2026</b>	144.4	99.8	10.7	14.5	68.9	117.3	46.6	12.0	1.7	21.4	<b>537.3</b>
<b>2027</b>	196.5	135.6	13.2	20.9	89.4	165.3	65.7	16.7	2.4	28.1	<b>733.8</b>
<b>2028</b>	258.4	178.1	15.6	29.3	111.8	226.9	90.2	22.6	3.3	36.1	<b>972.3</b>
<b>2029</b>	330.2	227.3	18.2	40.2	136.1	305.4	121.3	29.9	4.5	45.5	<b>1258.6</b>
<b>2030</b>	411.1	282.8	20.7	54.2	161.7	404.3	160.7	39.0	6.0	56.4	<b>1596.9</b>
<b>2031</b>	499.6	343.7	23.2	71.5	188.3	527.6	209.6	50.1	7.7	69.2	<b>1990.5</b>
<b>2032</b>	593.7	408.5	25.7	92.3	215.3	1241.8	493.4	63.5	9.9	84.0	<b>3228.1</b>
<b>2033</b>	690.6	475.5	28.2	116.3	242.4	1576.1	626.2	79.7	12.4	101.3	<b>3948.7</b>
<b>2034</b>	787.9	543.0	30.7	143.0	269.5	1944.2	772.5	98.9	15.4	121.3	<b>4726.4</b>
<b>2035</b>	883.3	609.3	33.2	171.1	296.2	2328.6	925.2	121.9	19.0	144.2	<b>5532</b>

## Electrification & Renewables to Displace Fossil Fuel Process Heating

Table 43: Summary of fossil fuel cost reduction from process heat for all sectors investigated in the current analysis for the accelerated scenario relative to business as usual

ACL Fossil Fuel Cost Reduction vs BaU (millions of \$)											
	Hotels	Healthcare	Beer Processing	Dairy Processing	Meat Processing	Alumina refining	Non-Ferrous Metals (ex Alumina)	Pulp and Paper	Wood drying	Other manufacturing	Approx. Total
<b>2019</b>	\$0.0	\$0.0	\$0.0	\$0.0	\$0.0	\$0.0	\$0.0	\$0.0	\$0.0	\$0.0	\$0.0
<b>2020</b>	\$0.0	\$0.0	\$0.0	\$0.0	\$0.0	\$0.0	\$0.0	\$0.0	\$0.0	\$0.0	\$0.0
<b>2021</b>	\$0.0	\$0.0	\$0.0	\$0.0	\$0.0	\$0.0	\$0.0	\$0.0	\$0.0	\$0.0	\$0.0
<b>2022</b>	\$0.5	\$0.7	\$0.4	\$0.3	\$1.2	\$1.7	\$0.7	\$0.3	\$0.0	\$0.5	\$6.3
<b>2023</b>	\$1.2	\$1.5	\$0.8	\$0.8	\$2.6	\$3.9	\$1.6	\$0.7	\$0.1	\$1.0	\$14.2
<b>2024</b>	\$2.1	\$2.6	\$1.3	\$1.4	\$4.3	\$6.8	\$2.7	\$1.2	\$0.1	\$1.7	\$24.2
<b>2025</b>	\$3.3	\$4.0	\$1.8	\$2.3	\$6.2	\$10.6	\$4.2	\$1.6	\$0.2	\$2.5	\$36.7
<b>2026</b>	\$4.7	\$5.7	\$2.3	\$3.4	\$8.4	\$15.6	\$6.2	\$2.0	\$0.3	\$3.4	\$52.0
<b>2027</b>	\$6.3	\$7.7	\$2.8	\$5.0	\$10.9	\$21.9	\$8.7	\$2.7	\$0.5	\$4.5	\$71.0
<b>2028</b>	\$8.3	\$10.2	\$3.3	\$7.0	\$13.7	\$30.1	\$12.0	\$3.7	\$0.6	\$5.7	\$94.6
<b>2029</b>	\$10.6	\$13.0	\$3.9	\$9.6	\$16.7	\$40.5	\$16.1	\$4.9	\$0.9	\$7.2	\$123.4
<b>2030</b>	\$13.2	\$16.1	\$4.4	\$12.9	\$19.8	\$53.6	\$21.3	\$6.4	\$1.1	\$8.9	\$157.7
<b>2031</b>	\$16.1	\$19.6	\$5.0	\$17.0	\$23.1	\$70.0	\$27.8	\$8.2	\$1.5	\$10.9	\$199.2
<b>2032</b>	\$19.1	\$23.3	\$5.5	\$21.9	\$26.4	\$164.8	\$65.4	\$10.4	\$1.9	\$13.3	\$352.0
<b>2033</b>	\$22.3	\$27.1	\$6.0	\$27.7	\$29.7	\$209.1	\$83.0	\$13.0	\$2.4	\$16.0	\$436.3
<b>2034</b>	\$25.4	\$31.0	\$6.6	\$34.0	\$33.0	\$258.0	\$102.4	\$16.1	\$3.0	\$19.2	\$528.7
<b>2035</b>	\$28.5	\$34.7	\$7.1	\$40.7	\$36.3	\$308.9	\$122.6	\$19.9	\$3.7	\$22.8	\$625.2

